



# **Astronomy**

# **For Mere Mortals**

**An Introductory Astronomy Text**

**Aaron Clevenson**

**Copyright © 2023 Aaron B. Clevenson.** All Rights Reserved. No part of these materials may be reproduced or distributed without the prior written permission of the author.

## **Acknowledgements / Credits**

All Photographs, unless otherwise indicated, are public domain. All astronomical photographs in this text are provided courtesy of NASA, unless otherwise indicated. ([www.nasa.gov](http://www.nasa.gov))

All diagrams are original to the author, Aaron Clevenson, unless otherwise indicated.

Special thanks to David Tomlin and John Wakefield for their contributions, comments, edits, feedback, and support. Also, special thanks to the astronomy students at Lone Star College - Montgomery in the fall of 2016 for their tireless identification of mistakes in the text.

***Nam et ipsa scientia potestas est.***

Knowledge is power

***Per aspera ad astra!***

Through hard work we reach the stars.

## Introduction

Welcome to the universe! We earthlings spend our lives here on Earth, busy in our affairs; we are born, we learn, we work, we have families, and we grow old. We are so consumed by the things we do, that we do not take the time to look up, to look at the heavens, and to enjoy the wonders of the universe.

Learning about astronomy is a way for all of us to share in that universe. There are planets, stars, and galaxies waiting to be found. We just need to look. The more we understand about how it all works and how it all fits together, the greater its grandeur.

There are many quality texts available for astronomy, but they are often at a higher level than is appropriate for introductory astronomy courses taught often to non-science majors. New astronomers need a textbook that will facilitate learning and provide a way for them to incorporate astronomy components with things they already know. We want to incorporate astronomical terminology as the reader progresses through the material, but in a way that is clear and seamless for non-scientists.

Rather than create chapters that contain multiple components, we have broken the material into individual components. They are arranged in a logical progression from the basics through planetary astronomy, the Sun, stellar astronomy, and on through cosmology. This makes it easy for the reader to study components in the order that works best for them.

Another driving principle is to lower the financial threshold to new astronomers that are ready to take the plunge. This text is provided free to readers electronically. The knowledge contained in this text is free.

The purpose of this text is to take a break in our busy lives, look into the depths of the universe, and to try to understand what we see. Astronomy is part of physics, so to truly understand and appreciate what we see, there will be some physics involved. Although the components do often build on previous components, they also stand alone to teach information on a specific topic.

At the conclusion of studying this text, the reader will have an understanding of the universe and will see how the many pieces fit together.

Aaron Clevenson  
Astronomer

## How to Use This Text

The text assumes that this information may be conveyed as a single course, or as two courses of study: Solar System Astronomy, and Stars and Galaxies Astronomy. Rather than conventional chapters, the material is organized around Components. If you learn the material of the entire text, then you will have a complete picture of the universe.

If you are learning the material as two courses, there are some Components that are fundamental to both courses and are part of both courses, Components 1 through 35 and components 96 through 102. These are the Basics, History, Measurements, the Sun, and Cosmology.

- Solar System Astronomy includes: Components 1 through 102
- Stars and Galaxies Astronomy includes: Components 1 through 35 and 96 through 191

The courses have also been broken up into teaching units to make the material manageable. The Solar System Astronomy Course has four teaching units, and the Stars and Galaxies Astronomy Course has five teaching units due to a larger amount of content. The first two units are identical when taught as two separate courses.

Teaching Units	Solar System Astronomy	Stars and Galaxies Astronomy
<b>1</b>	Components 1 to 17	Components 1 to 17
<b>2</b>	Components 18 to 35	Components 18 to 35
<b>3</b>	Components 36 to 50	Components 96 to 117
<b>4</b>	Components 51 to 77	Components 118 to 153
<b>5</b>	Components 78 to 102	Components 154 to 191

This textbook and associated learning materials are part of a complete astronomy course. The course should also include laboratory sessions to study the tools used in astronomy as well as observing sessions. In the observing sessions readers should experience using various types of telescopes, binoculars, and their eyes. You are encouraged to keep detailed observation logs which include sketches and relevant observational data.

## Table of Contents

Acknowledgements / Credits.....	2
Introduction .....	3
How to Use This Text .....	4
Table of Contents.....	5
Table of Equations .....	13
Table of Examples.....	13
*** SECTION I. ASTRONOMY – BASICS .....	15
Component 1 – How we fit in.....	16
Component 2 – It’s All About Me .....	22
Component 3 – How We Measure Angles .....	24
Component 4 – Scientific Theories, Scientific Method .....	27
Component 5 – Remembering Which Star is Which .....	29
Component 6 – Nothing is Perfect in Astronomy .....	31
Component 7 – Space is Really Big!.....	32
Component 8 – Everything in Space is Moving .....	33
Component 9 – Motions of the Earth.....	35
Component 10 – Lunar Phases.....	38
Component 11 – Eclipses.....	40
*** SECTION II. ASTRONOMY – HISTORY .....	45
Component 12 – The Science of Early People .....	46
Component 13 – The Beginning of Scientific Thinking.....	51
Component 14 – A Scientific Approach is Born.....	54
Component 15 – Harvard University’s Computers.....	59
Component 16 – Modern Astronomy .....	60
*** SECTION III. ASTRONOMY – MEASUREMENT .....	61
Component 17 – Earth-Based Coordinates .....	62
Component 18 – The Nature of Light.....	66

## Astronomy for Mere Mortals – An Introductory Astronomy Text

Component 19	– Electromagnetic Radiation .....	70
Component 20	– Tools for Mere Mortals.....	72
Component 21	– Recording What We See .....	78
Component 22	– Seeing More Detail .....	80
Component 23	– Space from Space .....	82
Component 24	– Seeing Beyond the Visible .....	84
Component 25	– Seeing it All .....	89
Component 26	– Interferometry .....	90
Component 27	– Photons from Electron Energy States.....	92
Component 28	– Black Body Curves.....	96
Component 29	– Kirchhoff’s Laws .....	98
Component 30	– More Energy States .....	100
Component 31	– The Doppler Effect.....	102
Component 32	– The Language of Light.....	104
Component 33	– How Far is That? .....	105
Component 34	– Redshifts .....	111
Component 35	– Extrasolar Planets .....	112
*** SECTION IV. ASTRONOMY – THE SOLAR SYSTEM .....		115
Component 36	– Solar System Roll Call.....	116
Component 37	– Solar System Blueprint.....	118
Component 38	– Solar System Formation.....	120
Component 39	– Comparative Planetology .....	123
Component 40	– Solar System Exploration .....	127
Component 41	– The Earth’s Data.....	133
Component 42	– Earth’s Structure .....	134
Component 43	– Earth’s Atmosphere .....	137
Component 44	– Earth’s Surface .....	143
Component 45	– Earth’s Magnetosphere .....	147
Component 46	– The Moon’s Data.....	149

## Astronomy for Mere Mortals – An Introductory Astronomy Text

Component 47	– The Moon’s Origin .....	150
Component 48	– The Moon’s Structure .....	151
Component 49	– The Moon’s Surface .....	152
Component 50	– Tidally Locked .....	155
Component 51	– Mercury’s Data .....	156
Component 52	– Mercury’s Structure .....	157
Component 53	– Mercury’s Surface .....	158
Component 54	– Mercury’s Orbit .....	159
Component 55	– Venus’ Data .....	161
Component 56	– Venus’ Structure and Surface .....	162
Component 57	– Venus’ Orbit and Orientation .....	165
Component 58	– Venus’ Atmosphere .....	166
Component 59	– Mars’ Data .....	168
Component 60	– Mars’ Structure .....	169
Component 61	– Mars’ Atmosphere .....	170
Component 62	– Mars’ Surface .....	171
Component 63	– Mars’ Moons .....	177
Component 64	– Jupiter’s Data .....	178
Component 65	– Jupiter’s Structure .....	180
Component 66	– Jupiter’s Atmosphere .....	181
Component 67	– Jupiter’s Magnetosphere .....	183
Component 68	– Jupiter’s Moons .....	184
Component 69	– The Roche Limit .....	187
Component 70	– Jupiter’s Ring .....	188
Component 71	– Saturn’s Data .....	189
Component 72	– Saturn’s Structure .....	191
Component 73	– Saturn’s Atmosphere .....	192
Component 74	– Saturn’s Magnetosphere .....	194
Component 75	– Saturn’s Moons .....	195

## Astronomy for Mere Mortals – An Introductory Astronomy Text

Component 76	– Saturn’s Rings.....	198
Component 77	– Lagrangian Objects .....	200
Component 78	– Uranus’ Data .....	201
Component 79	– Uranus’ Structure.....	202
Component 80	– Uranus’ Atmosphere.....	203
Component 81	– Uranus’ Magnetosphere.....	204
Component 82	– Uranus’ Moons .....	205
Component 83	– Uranus’ Rings .....	206
Component 84	– Neptune’s Data .....	207
Component 85	– Neptune’s Structure .....	209
Component 86	– Neptune’s Atmosphere.....	210
Component 87	– Neptune’s Magnetosphere.....	211
Component 88	– Neptune’s Moons .....	212
Component 89	– Neptune’s Rings .....	213
Component 90	– Parade of the Major Moons .....	214
Component 91	– Dwarf Planets.....	215
Component 92	– Asteroids.....	220
Component 93	– Comets .....	223
Component 94	– Meteoroids .....	226
Component 95	– The Kuiper Belt, Oort Cloud and Extrasolar Visitors.....	230
*** SECTION V. ASTRONOMY – SOLAR .....		233
Component 96	– Stellar Habitable Zones.....	234
Component 97	– The Sun’s Data .....	236
Component 98	– The Sun’s Atmosphere.....	237
Component 99	– The Sun’s Spectrum .....	238
Component 100	– The Sun’s Structure .....	239
Component 101	– The Sun’s Surface .....	242
Component 102	– Fusion in the Sun .....	245
*** SECTION VI. ASTRONOMY – STARS and GALAXIES .....		249



## Astronomy for Mere Mortals – An Introductory Astronomy Text

Component 103	– The Motion of Stars.....	250
Component 104	– The Luminosity of Stars.....	251
Component 105	– The Temperature of Stars .....	252
Component 106	– Spectral Classification of Stars .....	253
Component 107	– The HR Diagram.....	254
Component 108	– The Sizes of Stars.....	260
Component 109	– Special Members of the Stellar Family.....	261
Component 110	– The Sun’s Childhood.....	263
Component 111	– The Sun’s Elder Years .....	267
Component 112	– The Lives of Small Stars .....	271
Component 113	– The Lives of Larger Stars.....	273
Component 114	– Time on the Main Sequence .....	276
Component 115	– End States for Different Mass Stars .....	277
Component 116	– Fusion in Large Stars’ Cores .....	278
Component 117	– Temperatures for Core Fusion .....	281
Component 118	– Fusion in the S-Process.....	282
Component 119	– Fusion in the R-Process .....	283
Component 120	– Magnitudes and Luminosities .....	284
Component 121	– Data on Spectral Types.....	286
Component 122	– Stars in the Local Neighborhood.....	288
Component 123	– Stellar Distributions.....	290
Component 124	– Stellar Populations .....	291
Component 125	– Interstellar Dust and Gas.....	292
Component 126	– Dark Nebulae.....	293
Component 127	– Emission Nebulae .....	294
Component 128	– Reflection Nebulae.....	295
Component 129	– Forbidden Lines in Spectra.....	296
Component 130	– Open Star Clusters.....	297
Component 131	– Planetary Nebulae.....	298

## Astronomy for Mere Mortals – An Introductory Astronomy Text

Component 132	– Core Collapse Supernovae .....	300
Component 133	– Neutron Stars .....	301
Component 134	– Pulsars .....	302
Component 135	– Gamma Ray Bursts .....	303
Component 136	– Black Holes .....	304
Component 137	– Einstein and Relativity.....	305
Component 138	– Binary Stars.....	309
Component 139	– Novae .....	310
Component 140	– Carbon Detonation Supernovae .....	311
Component 141	– Gravitational Waves.....	312
Component 142	– Classification of Galaxies .....	313
Component 143	– Spiral and Barred Spiral Galaxies .....	314
Component 144	– Elliptical Galaxies.....	316
Component 145	– Irregular Galaxies .....	317
Component 146	– Galactic Comparisons.....	318
Component 147	– Galaxy Clusters .....	319
Component 148	– Galaxy Recession and Red Shift .....	322
Component 149	– Milky Way Galaxy Dimensions .....	323
Component 150	– Mass of the Milky Way Galaxy .....	324
Component 151	– Milky Way Structure.....	325
Component 152	– Milky Way Spiral Arms .....	327
Component 153	– Milky Way Formation.....	328
Component 154	– Globular Clusters.....	329
Component 155	– Supermassive Black Hole.....	331
Component 156	– Active Galaxies .....	333
Component 157	– Quasars.....	334
Component 158	– Seyfert Galaxies.....	335
Component 159	– Radio Galaxies .....	336
Component 160	– Dark Matter .....	337

## Astronomy for Mere Mortals – An Introductory Astronomy Text

Component 161	– Galactic Mergers .....	339
Component 162	– Early Galactic Evolution.....	340
Component 163	– Galaxy Surveys.....	341
Component 164	– Lyman Alpha Evidence .....	342
*** SECTION VII. ASTRONOMY – COSMOLOGY.....		343
Component 165	– The Cosmological Principle .....	344
Component 166	– The Ultimate Fate of the Universe.....	345
Component 167	– Olber’s Paradox .....	347
Component 168	– The Big Bang: What, When, & Where.....	348
Component 169	– Evidence of the Big Bang.....	349
Component 170	– The Flatness Problem.....	350
Component 171	– The Horizon Problem .....	351
Component 172	– Inflation .....	353
Component 173	– Stages of Evolution of the Universe.....	354
Component 174	– The Planck Epoch .....	355
Component 175	– The Grand Unified Theory Epoch.....	356
Component 176	– The Quark Epoch.....	357
Component 177	– The Lepton Epoch.....	358
Component 178	– The Nuclear Epoch .....	359
Component 179	– The Atomic Epoch .....	360
Component 180	– The Galactic Epoch.....	361
Component 181	– The Stellar Epoch.....	362
Component 182	– Dark Matter and Structure.....	363
Component 183	– What is Life?.....	365
Component 184	– What do You Need for Life?.....	367
Component 185	– Sources for the Building Blocks .....	368
Component 186	– Origins in Space .....	369
Component 187	– Search for Life on Mars .....	370
Component 188	– Elsewhere in the Solar System.....	371

## Astronomy for Mere Mortals – An Introductory Astronomy Text

Component 189 – The Drake Equation .....	372
Component 190 – Search for Extraterrestrial Life .....	373
Component 191 – What Frequency to Use to Search?.....	374
Appendix 1: – Math for Mere Mortal Astronomers .....	375
Appendix 2 – Useful Astronomy Equations .....	381
Appendix 3 – Pronunciation Guide .....	389
Appendix 4 – Glossary of Terms.....	395
Appendix 5 – The Sun’s Stellar Neighborhood .....	416
Appendix 6 – The History of Astronomy .....	418
Index.....	475

## Table of Equations

EQUATION 1: CALCULATING WIDTH AND DISTANCE	25
EQUATION 2: FREQUENCY, WAVELENGTH AND PERIOD	68
EQUATION 3: PHOTON ENERGY	68
EQUATION 4: THE RYDBERG FORMULA	94
EQUATION 5: CONVERTING BETWEEN TEMPERATURE SCALES	97
EQUATION 6: DOPPLER EFFECT CALCULATION	103
EQUATION 7: MEASURING DISTANCE WITH VELOCITY	105
EQUATION 8: MEASURING DISTANCE WITH PARALLAX	108
EQUATION 9: THE DISTANCE MODULUS	108
EQUATION 10: MEASURING LUMINOSITY WITH THE TULLY-FISHER RELATION	109
EQUATION 11: MEASURING DISTANCE WITH HUBBLE’S LAW	110
EQUATION 12: RED-SHIFT CALCULATION	111
EQUATION 13: DISTANCE AS A FUNCTION OF LUMINOSITY AND TEMPERATURE	234
EQUATION 14: INVERSE-SQUARE LAW	251
EQUATION 15: CALCULATING STELLAR SIZE	260
EQUATION 16: SIZE IN SOLAR RADII	260
EQUATION 17: MAIN SEQUENCE TIME VS. MASS	276
EQUATION 18: NEUTRON CREATION	283
EQUATION 19: LUMINOSITY VS. ABSOLUTE MAGNITUDE	285
EQUATION 20: NEUTRON STAR FORMATION	301
EQUATION 21: THE EVENT HORIZON	304
EQUATION 22: TIME AND RELATIVITY	305
EQUATION 23: MASS AND RELATIVITY	305
EQUATION 24: VELOCITY AND RELATIVITY	305
EQUATION 25: MASS OF THE MILKY WAY GALAXY	324
EQUATION 26: THE DRAKE EQUATION	372

## Table of Examples

EXAMPLE 1: THE RYDBERG FORMULA, AN EXAMPLE .....	94
EXAMPLE 2: TRIANGULATION .....	107
EXAMPLE 3: PARALLAX .....	107



**\*\*\* SECTION I. ASTRONOMY – BASICS**

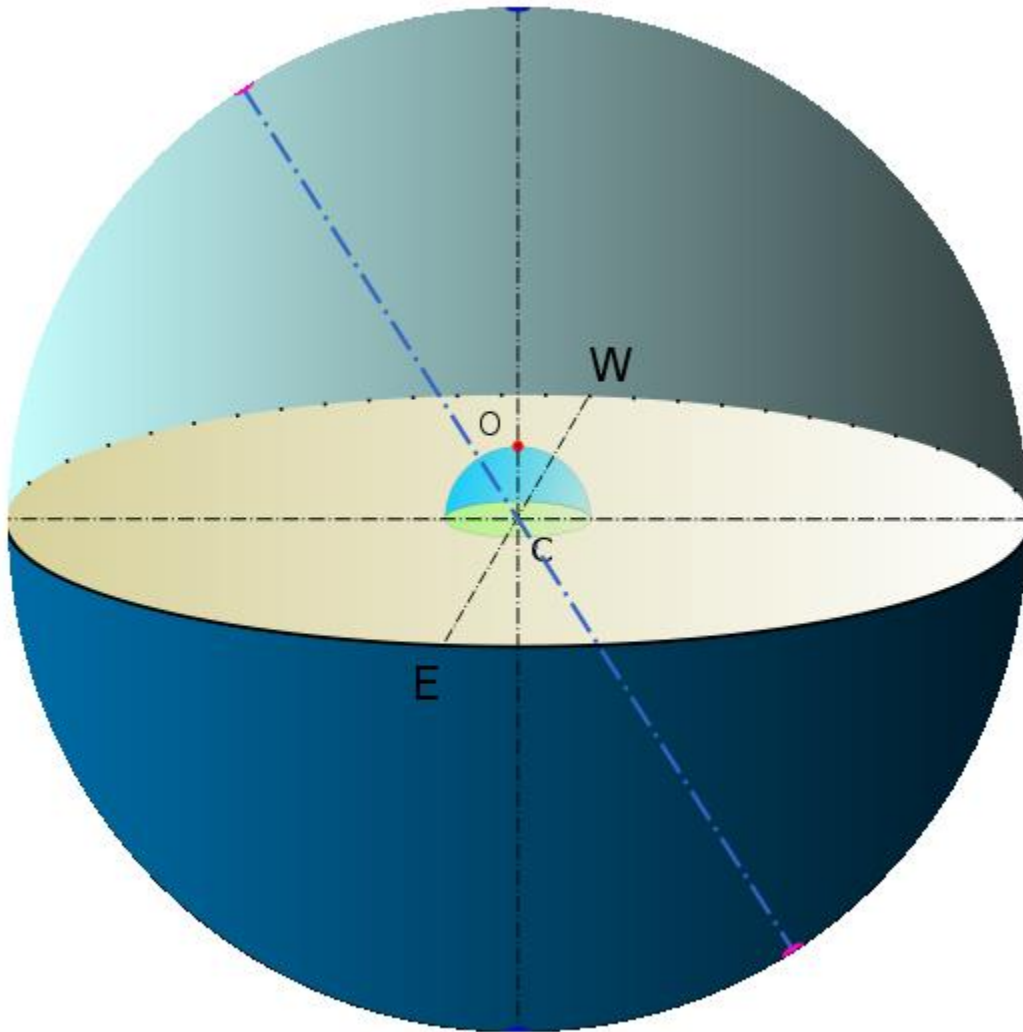


Diagram by CAV

## Component 1 – How we fit in

In the words of Star Trek: “Space the Final Frontier”. This is so true. We have only begun to explore space; we have only begun to understand the mechanics of the universe. The purpose of this text and this course is to introduce you to the universe, what we have seen out there, what we think we understand about how it all works, and to fit it into the perspective that we have as Earthlings bound to our planet.

Like any science there is terminology to learn and concepts to grasp, but astronomy is something you will have with you for the rest of your life. It is something you can share with your children and grandchildren. When you go camping in the wilds, or even when you walk from your car to your house, the sky is there in all its wonder and variety. Enjoy!

### Putting it all to Scale

Our planet, **Earth**, is what we all know and love. It is home. It provides air to breathe, food to eat, water to drink, and a comfortable environment in which to live. Although it seems quite large when you are standing on its surface, the universe is a very vast place, and on the scale of the universe, the Earth is but a microscopic speck. Let’s take a look at how things measure up.

**Earth.** The earth is a roughly spherical ball with an average planetary diameter of 7,917.5 miles. It is the only planet in the solar system with liquid water on its surface, oxygen in its atmosphere, and life.

Figure 1: Earth – 7917.5 miles diameter

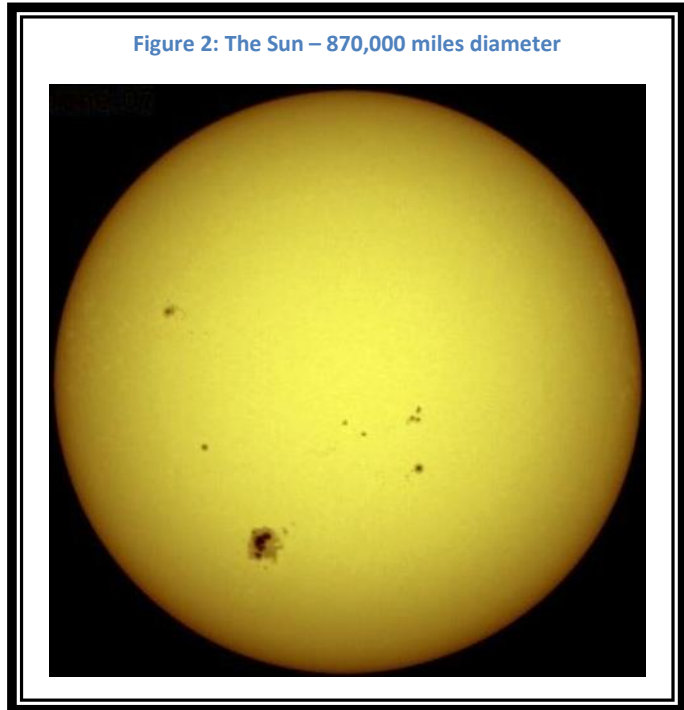


*The Earth has:*

- *Liquid Water*
- *Oxygen*
- *Life*



**The Sun.** While Earth is the center of our lives, the **Sun** is the center of the **Solar System**. The Sun is considerably larger than the Earth. In fact, you could fit roughly 110 Earth's across the diameter of the Sun. The Sun's diameter is roughly 870,000 miles. It has sunspots and solar flares that are larger than the Earth. The Earth is an average 93,000,000 miles from the Sun. This is called an AU (Astronomical Unit). The diameter of the Earth's orbit is 186,000,000 miles.



**The Solar System.** Everything that is affected by the Sun is part of the Solar System. This includes all of the planets, moons, asteroids, comets, meteoroids, dust, and gas that are close enough to the Sun to be effected by the Sun's gravity. This region extends nearly 2 light-years out from the Sun. This is  $1.175699962 \times 10^{13}$  miles or about 12 trillion miles.

**Nearest Stellar Neighbor.** The Sun's nearest neighbor is Proxima Centauri. This is a small red dwarf star that is 4.243 light-years away. It is part of the Alpha Centauri multiple-star system.

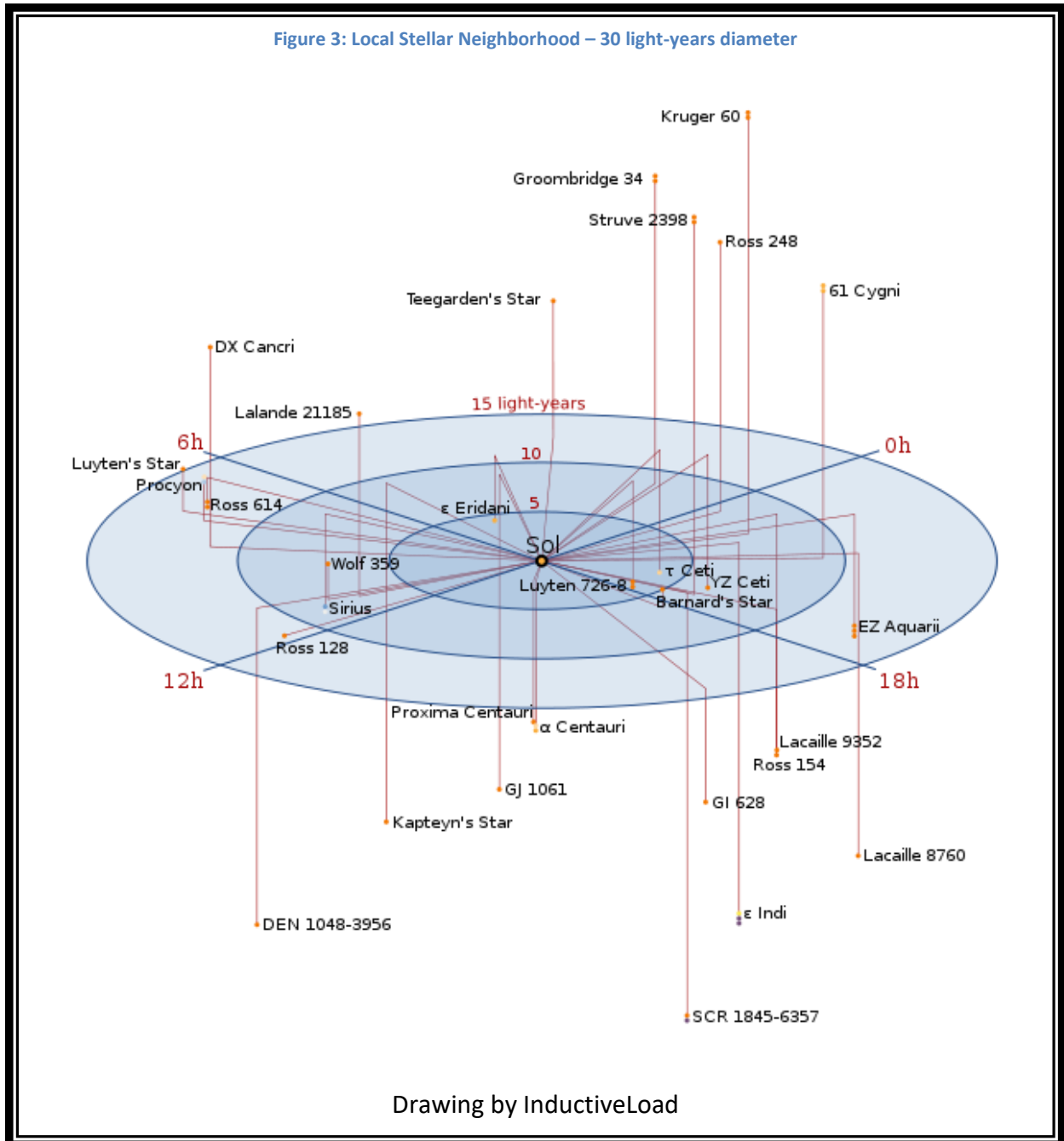
Table 1: Measuring Distances in Astronomy (using miles)

1 foot	=	12 inches
1 mile	=	5280 feet
1 AU	=	92955807.5 miles
1 light-year	=	63,239.7263 AU
1 parsec	=	3.26 light-years

Table 2: Measuring Distance in Astronomy (using kilometers)

1 kilometer	=	1000 meters
1 AU	=	149,597,871 km
1 light-year	=	63,239.7263 AU
1 parsec	=	3.26 light-years

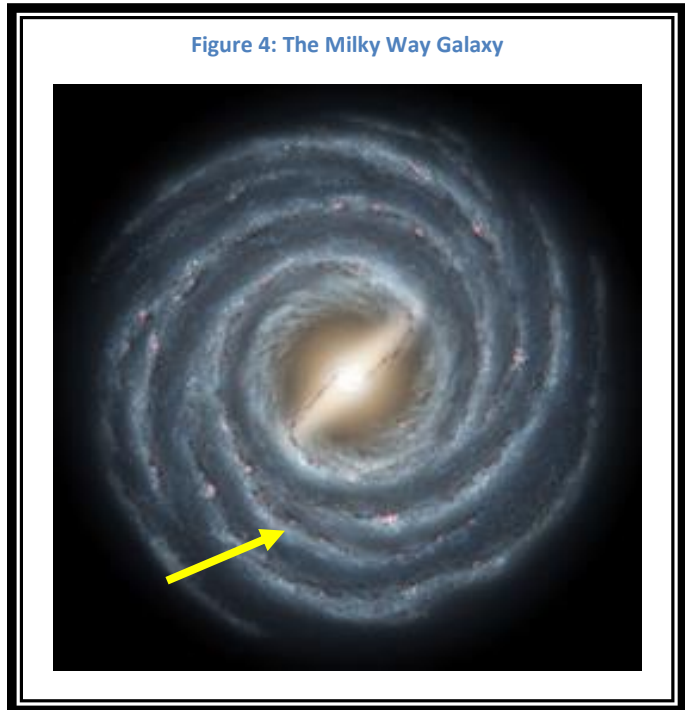
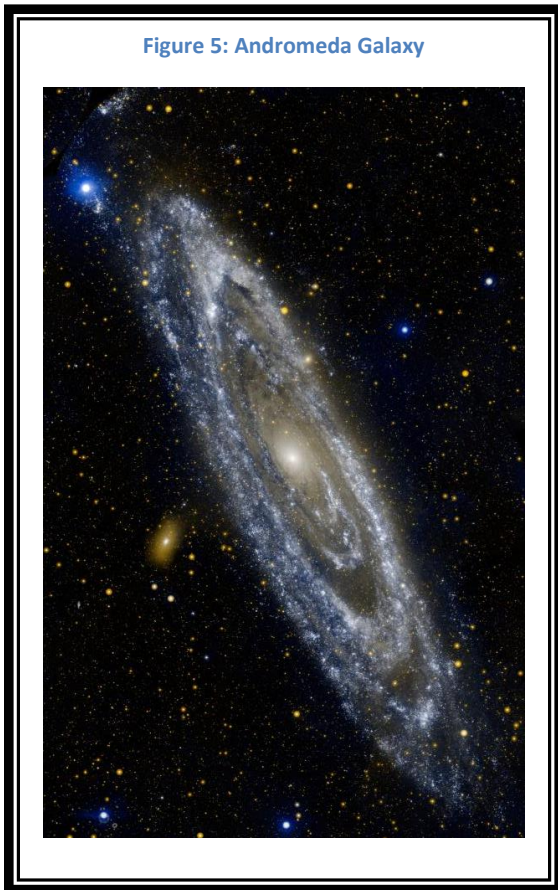
**The Local Stellar Neighborhood.** The limit on how far the local neighborhood extends is not well defined. 30 light-years diameter is a reasonable limit. Figure 3 shows the plane of our solar system extended outward 15 light-years. The red lines drawn to the stars extend outward from the Sun and then either upwards or downwards to represent their height above or below that plane.



**Stars in the Neighborhood.** The stars in the Sun’s neighborhood can be found in Appendix 5 – The Sun’s Stellar Neighborhood. The nearest star is **Proxima Centauri**.

**The Milky Way Galaxy.** Our local galaxy is called the **Milky Way**. It is roughly 100,000 light-years in diameter. The yellow arrow in Figure 4 points to the location of the Sun.

The Milky Way galaxy has a number of smaller companion galaxies. These galaxies orbit the Milky Way.

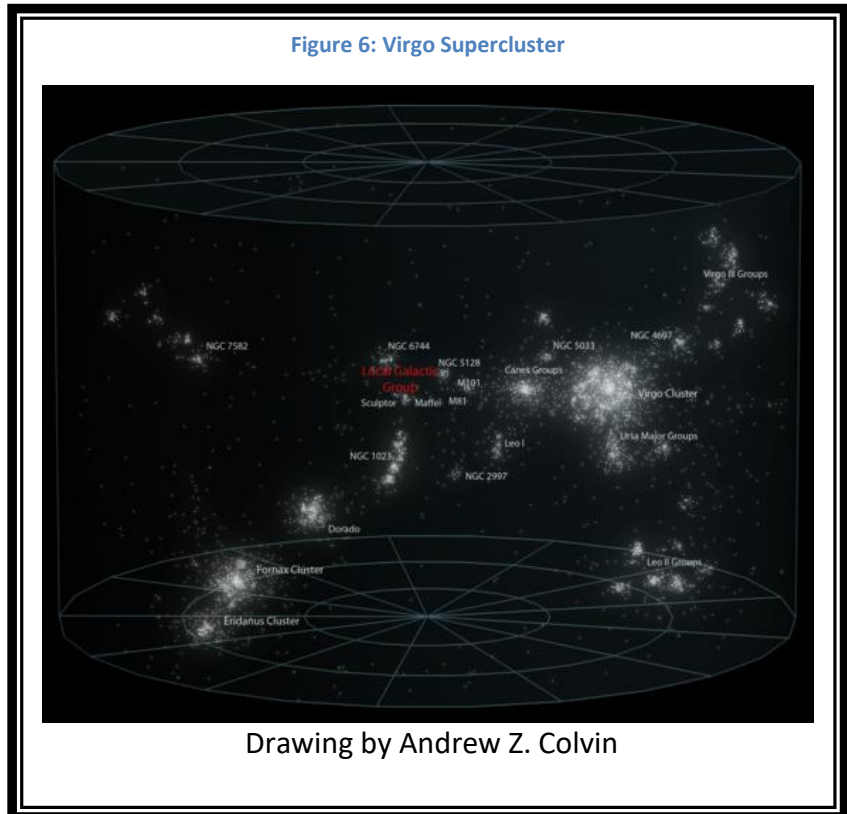
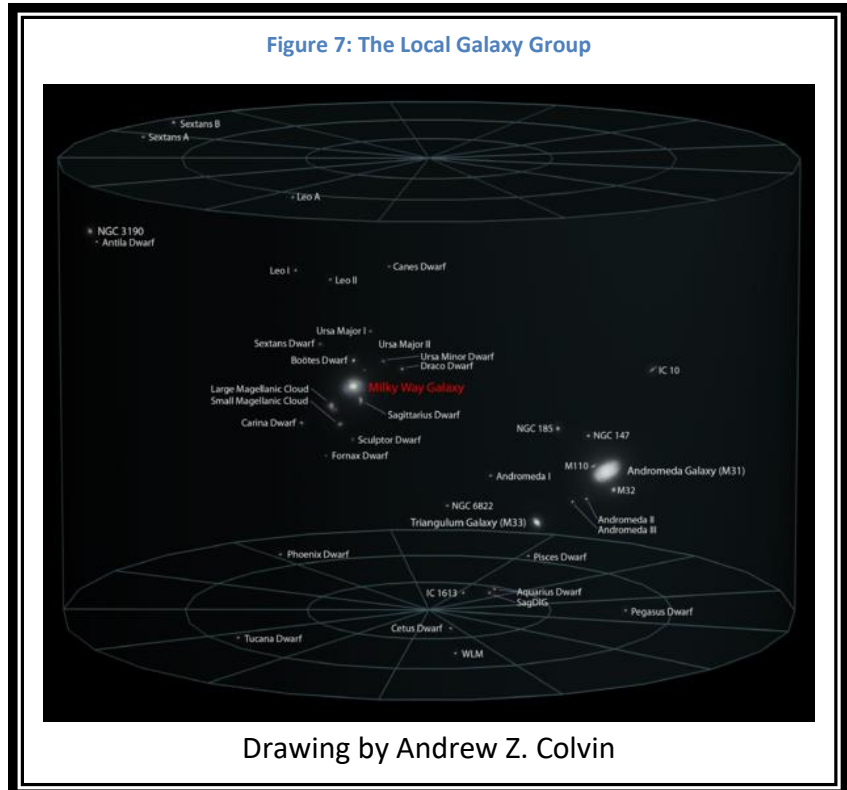


**Andromeda Galaxy.** Our nearest large galactic neighbor is the Andromeda Galaxy. It is located 2.4 million light-years away. The Andromeda Galaxy has many more companion galaxies than the Milky Way.

**The Local Galaxy Group.**

The Andromeda Galaxy and the Milky Way Galaxy plus all of the companion galaxies comprise the **Local Group**. Its diameter is 10 million light-years and it is composed of 54 galaxies. In Figure 7, members of the local galaxy group are shown. The blue ovals represent distances in the plane of the Milky Way Galaxy and the lines represent the distance to the other galaxies in the plane and also above and below that plane. The Local Galaxy Group consists of three Spiral Galaxies: The Milky Way, Andromeda, and M33. There are also many Irregular Galaxies and Elliptical Galaxies.

**The Virgo Supercluster.** The Local Group of Galaxies is part of the **Virgo Supercluster**. The supercluster is defined as the local space out to 110 million light-years. It contains over 100 galaxy groups and clusters.

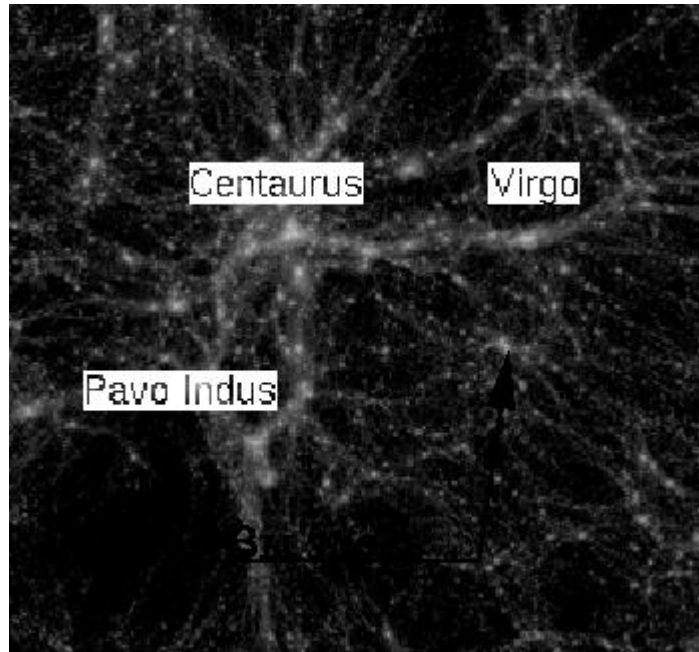


**The Local Galaxy Supercluster.**

The Local Supercluster of galaxies is the Laniakea Supercluster. Its diameter is 520 million light-years and is composed of over 100,000 galaxies. The Milky Way Galaxy is part of one section of the supercluster called the Virgo Supercluster.

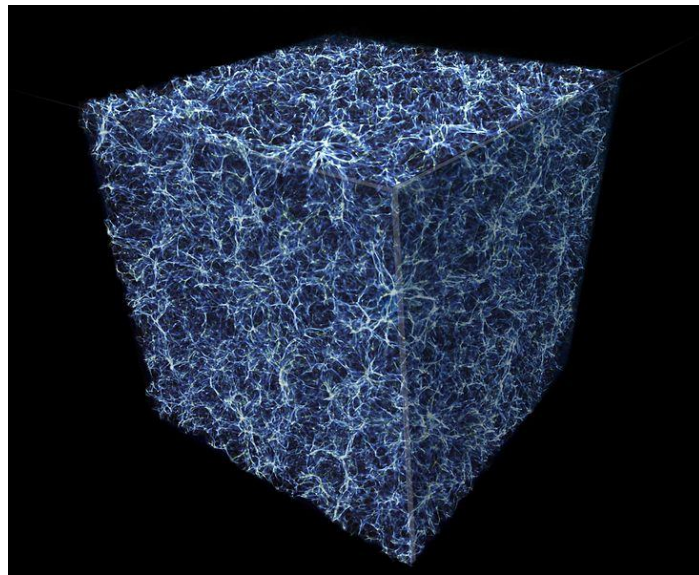
**The Universe.** As we gaze out into the far reaches of space we run into a problem. The further out we look, the farther back in time we are looking. It is not possible to get a true picture of what the universe actually looks like. We are able to look at galaxies and structures, but there is a limit to how far we can see. We also do not know how big the **Universe** is. We know that it is larger than the portion that we are able to see. Figure 9 represents a piece of the universe. It includes the **filaments** of galaxies and the **voids** where there are very few galaxies.

Figure 8: The Local Supercluster



Drawing by Klaus Dolag

Figure 9: The Universe



## Component 2 – It's All About Me

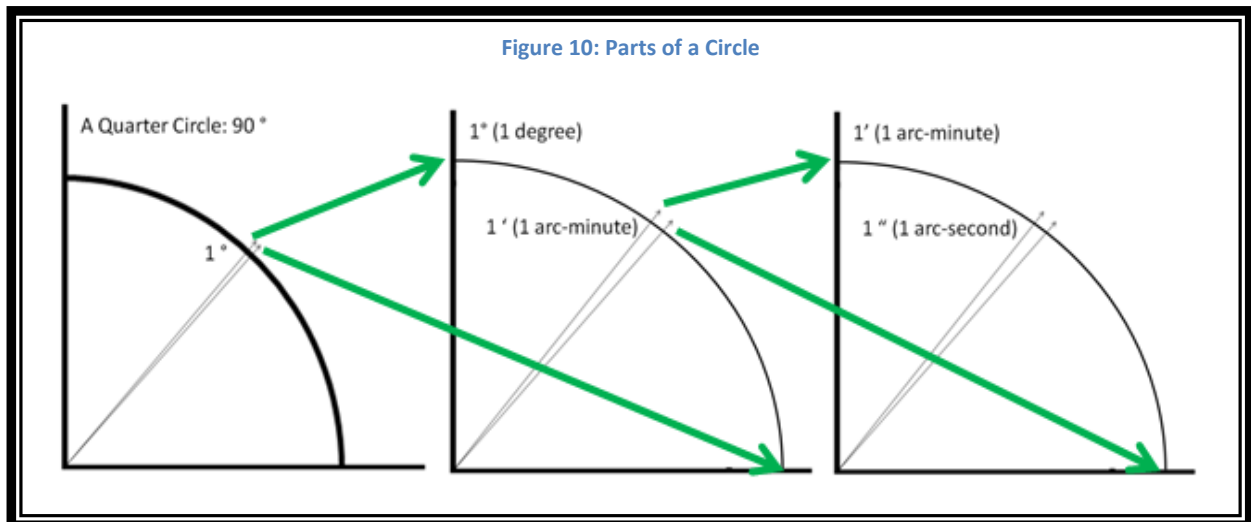
Although we are not the center of the universe, we are the center of our lives: our families, our activities, ourselves. It is only natural that when we look outward at the world around us, at the solar system or at the universe overall, we think of it in terms of ourselves. After all, we perceive the universe through our eyes, so everything we see is outward from those eyes.

There is great pleasure and enjoyment in gazing at the heavens. I could do it for hours and hours. But astronomy is a science, and that means as astronomers we need to make accurate observations, and then make careful measurements of those observations. Let's take a closer look at how we measure what we observe.

### Parts of a Circle

When we measure distances in a room, we measure distance up and down (height), distance right and left (width), and distance away from us (length). But when we measure distances to objects in the celestial sphere, we need to use spherical coordinates. These coordinates are also distance along the sphere to the right and left, distance along the sphere up and down, and distance away from us. The first two, since they are along a sphere, are measured as angles; angle to the right or left, and angle up or down.

Coordinates when measured in angular distances are measured in **degrees** ( $^{\circ}$ ), **arc-minutes** ( $'$ ), and **arc-seconds** ( $''$ ) (see Figure 10). These are parts of a circle. A complete circle has  $360^{\circ}$  (degrees). Each degree has  $60'$  (arc-minutes), and each arc-minute has  $60''$  (arc-seconds).



The way we map the universe is based on us and the things with which we are most familiar: the Earth. There are many coordinate systems that are used by astronomers. Each has its pros and cons. One way of mapping the universe is very similar to the way we map the surface of the Earth. Let's take a look at how we map the Earth.

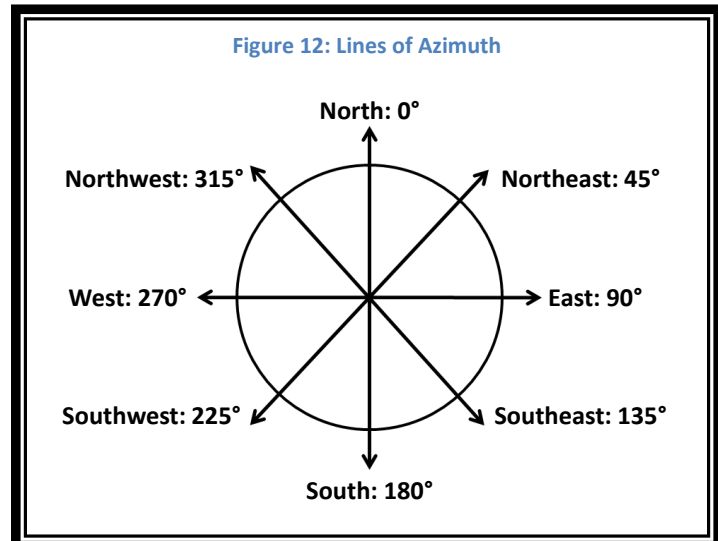
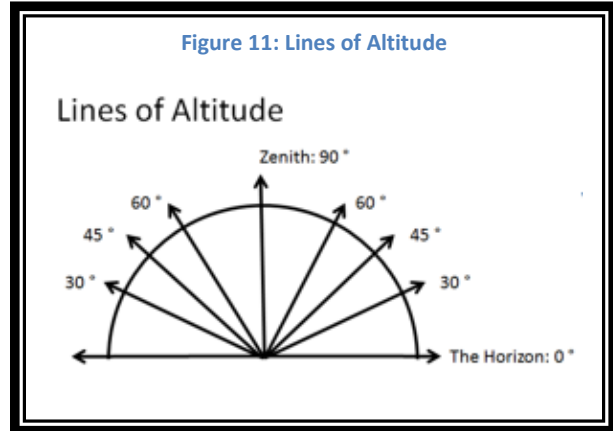
### Altitude and Azimuth

When we are in the field observing, we do not always know where the lines of Right Ascension and Declination are. Sometimes we want a system that lets us easily, and without equipment, tell the observers around us where an object is located. To do this we use **Altitude** and **Azimuth**.

Altitude (see Figure 11) is the angular height above the **horizon**. The horizon itself is 0 degrees Altitude. The point directly over your head, called the **Zenith**, is located at 90 degrees Altitude.

Azimuth (see Figure 12) is the angular distance around the horizon, starting with 0° Azimuth at North, 90° at East, 180° at South, and 270° at West. The Altitude and Azimuth coordinate

system is based on the center of your head. Different observers' heads are in different locations, so the center of this coordinate system is different for every observer. If they are close to you, then the difference is so small it is usually negligible.



## Component 3 – How We Measure Angles

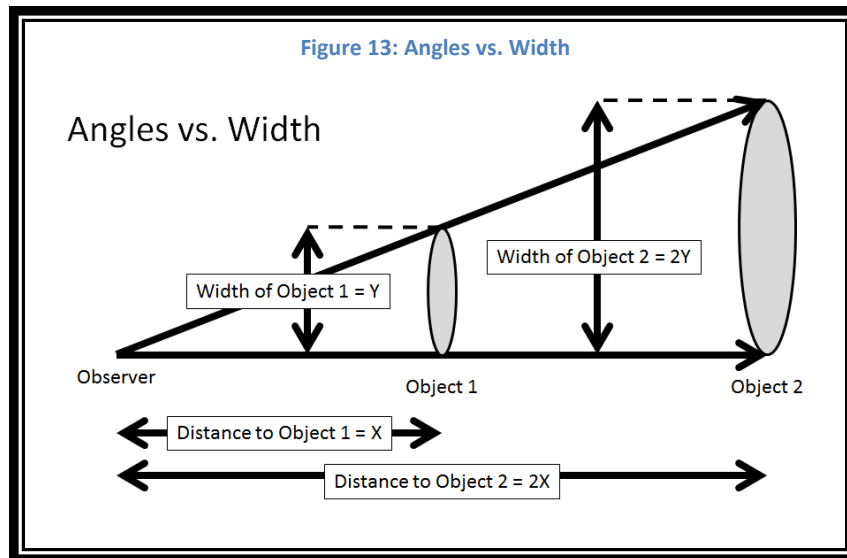
Astronomers have sophisticated equipment that lets them very accurately measure angles in the sky. But that is no help to most of us. We find ourselves out in a field with a modest telescope or binoculars. How do we take measurements? And once we have those measurements how can we convert them into distances?

### Angular Distances

Using an angular distance does not tell us how many miles or kilometers wide that angle is. The actual width in miles or kilometers depends on how far away the object is.

As you move away from the observer, the angle stays the same, but the width of that angle at the object grows (see Figure 13). If you keep the angular width the same and double the distance, then you also double the size of the width whether in miles or kilometers.

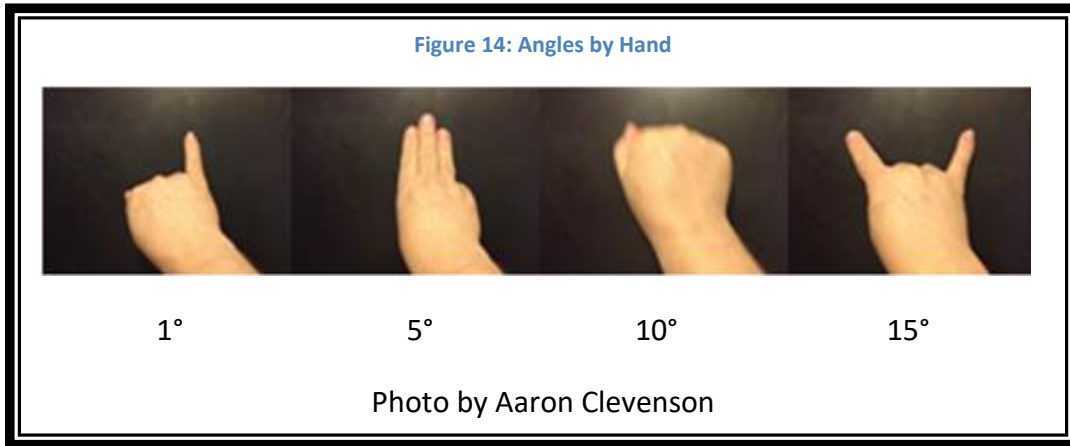
To measure the actual size of an object, you can calculate it from the angular distance if you know the distance to the object.



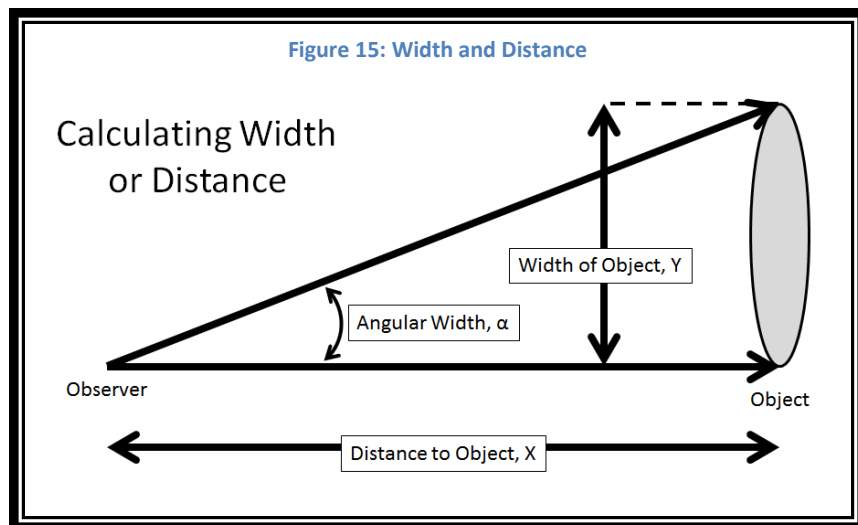
### Measuring Angles with Your Hands

You can measure angles in the sky with your hands held out at arm's-length. You can easily measure an angular distance of  $1^\circ$ ,  $5^\circ$ ,  $10^\circ$ , and  $15^\circ$  (see Figure 14).





You start at a known location, for example 0° Altitude, the horizon. You then add hand measurements until you reach your object. Or you could start at south, 180° Azimuth, and add hand measurements until you reach your object.



**Equation 1: Calculating Width and Distance**

Definition of the Tangent function:

$$\tan(\alpha) = \frac{\textit{Opposite Side}}{\textit{Adjacent Side}} = \frac{\textit{Object Width}}{\textit{Object Distance}} = \frac{Y}{X}$$

Calculate the Width of the Object:

$$Y = \tan(\alpha) * X$$

Calculate the Distance to the Object:  $X = \frac{Y}{\tan(\alpha)}$

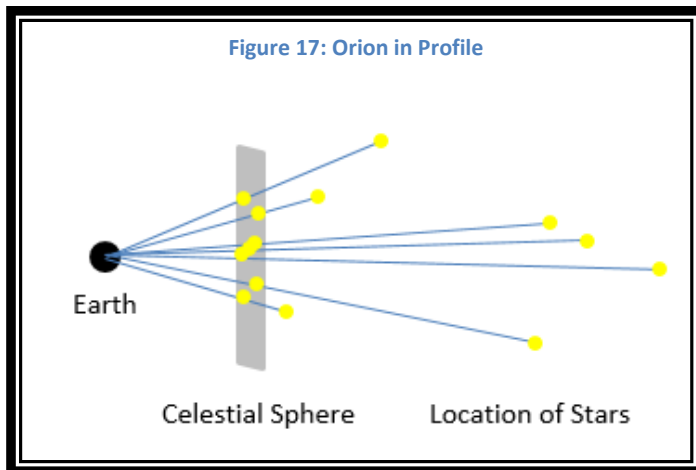
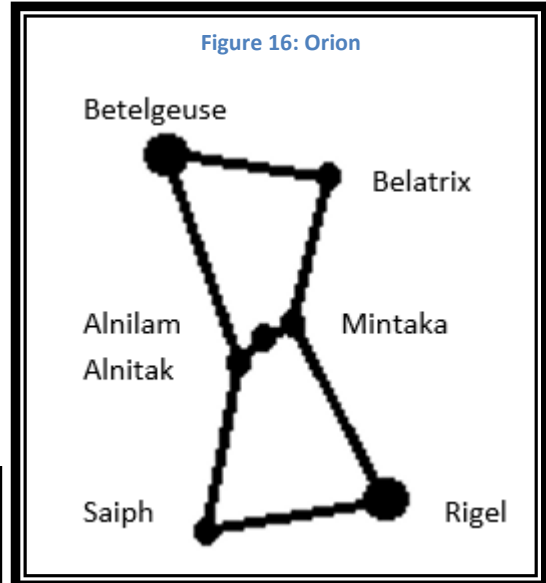
**Calculating the Width:**

If you know the angular width of an object, and you know how far away it is, you can calculate its actual width in miles or kilometers. This is called **Triangulation** and only requires basic trigonometry. You can also calculate its distance if you know its actual width and its angular width.

Equation 1 defines the mathematical meaning of tangent. We then use that function to calculate the object’s width or the object’s distance. We must know two of the three measurements: distance, width, and angle. We can then calculate the third value.

**What You See is Not Always What It Is**

When you look into space, it appears that all of the stars, planets, and galaxies you see are all painted on a giant sphere far overhead. We refer to this sphere as the **Celestial Sphere**. It is an illusion. The objects are all at various distances from the Earth. To see this for yourself, close one eye, hold a finger up about 6 inches from that eye, and then hold a finger from the other hand as far away from that



eye as possible, but in the same direction. Both fingers appear to be close together, but in reality they are over a foot apart. This is the same for objects in space; they may be aligned and appear close together, when in reality they could be many light-years apart.

Consider the constellation Orion. On the celestial sphere the stars appear to be all at roughly the same distance (see Figure 16). But as we see in Figure 17, the stars are not really close together. Table 3 shows their actual distances from Earth.

Table 3: Distances to Stars in Orion

Star	Distance from Earth
Betelgeuse	642.5 light-years
Belatrix	244.6 light-years
Alnitak	800 light-years
Mintaka	916 light-years
Alnilam	1342 light-years
Saiph	171 light-years
Rigel	772.9 light-years

## Component 4 – Scientific Theories, Scientific Method

### Scientific Theories

Every **theory** is not a **Scientific Theory**. If you are trying to figure out how something works, or why it works, you develop a theory. But, to be a Scientific Theory, it must be pushed further. A Scientific Theory must be:

- Testable
- Continually Tested
- Simple
- Elegant

*Scientific Theories must be:  
Testable, Continuously  
Tested, Simple, and Elegant*

**Testable.** This means that there has to be some way to test the theory.

**Continuously Tested.** This means that although we have tested the theory in the past, we must continue to test it. One job of a scientist is to try to find ways to disprove a Scientific Theory.

**Simple.** This means that a Scientific Theory should only be as complex as it needs to be.

**Elegant.** This means that a Scientific Theory should be pleasing to the mind. A Scientific Theory that pulls together pieces that were previously separate, is elegant.

**Scientific Theories can Never be Proven to be True.** Scientific Theories can be proven to be false by one example of a repeatable outcome. It just takes one contradiction to tear down part or all of a theory. But since it is impossible to test every possible case of a situation, you can't prove that it is always true.

### Occam's Razor

**Occam's Razor** was named after William of Ockham who lived 1285 -1349 CE. This assertion says that if you have more than one hypothesis that predicts a result equally well, the one with the smallest number of assumptions should be selected. A more complicated solution may ultimately make better predictions, but initially if they all make equally good predictions, the smaller the number of assumptions that are made, the better. What this means is, simpler is better.

## The Scientific Method

There is a process that scientists follow when trying to understand something new and different. It is called the **Scientific Method** (see Figure 18). The three steps are:

- **Observation**
- **Theory**
- **Prediction**

**Observation.** As scientists do their work, there are things we do not understand. These things are brought to our attention as we do observations.

**Theory.** To try to understand why and how things happened, scientists develop a theory of what could have caused what they have seen. Since this is to be a Scientific Theory, it must be tested.

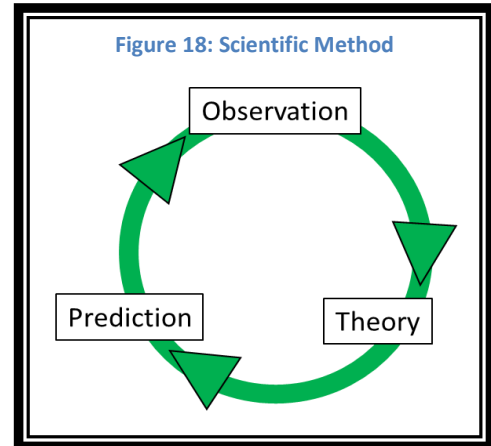
**Prediction.** Based on our Scientific Theory, we make a prediction about what should happen in the future. We then test our Prediction by making more Observations.

Although you can start anywhere in the circle, most often we initially see something we want to understand, so usually we start with Observation.

## Working the Process

Some examples of Scientific Theories and how they were tested are:

- **Newton's Laws of Gravity.** The laws depend on a gravitational constant. If the theory is correct, then everywhere we look in the universe we should see the same gravitational constant. When we look at Venus, Mars, or Jupiter, we see that they behave as Newton predicted with his laws.
- **Einstein's Theory of General Relativity.** This theory says that space is curved in the vicinity of massive objects. If this is true, then when there is a Total Solar Eclipse, stars that are slightly behind the Sun should appear beside the Sun as their light curves around the Sun. During a Total Solar Eclipse this is seen to be true, in the amount predicted by the Theory of General Relativity.



*The Scientific Method involves:  
Observation, Theory and Prediction*

## Component 5 – Remembering Which Star is Which

Since early prehistoric times, humans have needed to know what time of year it was. This information would tell them when to expect the annual floods or heavy rains. It would tell them when the last frost can be expected. It would tell them when to expect the yearly animal migrations. As humans began to leave land and go forth in boats, the stars could also tell them information on their latitude, and eventually even their longitude. These early humans discovered that the cycles in the stars would repeat year after year. To use the sky as a calendar, you need to be able to identify specific stars and groupings of stars. Although those groupings have changed over the years and from culture to culture, many cultures have created constellations to identify those groupings.

**The Babylonians.** The earliest evidence that we have found that demonstrate the use of constellations to map the sky date back to approximately 3000 BCE. They were found in Mesopotamia (in modern Iraq). It appears that most of their constellations were created from 1300 to 1000 BCE. These constellations were often adopted by the Greeks and Romans and modified to utilize their myths. The Babylonians had two functions for their constellations. One was related to their gods and symbols, the other was a farming calendar and contained everyday items such as farm workers, animals, and tools related to farming.

**The Chinese.** The oldest record of a star chart with constellations done by the Chinese is from 1092 CE. There is much evidence of the Chinese charting the night sky for thousands of years prior to this. There is some evidence that suggests that the Chinese constellations may have been influenced by those of Mesopotamia. Chinese astronomers were very accurately recording astronomical events and phenomena for millennia.

**The Indians** (of India). Indian astronomers were also influenced by the Mesopotamians. But there is evidence that they were recording astronomical events for many millennia. These constellations were largely based on their religion. Their oldest texts date back to 1400 to 1200 BCE.

**The Egyptians.** Egyptian astronomy began earlier than 4000 BCE. There are ancient stone circles that appear to be based on astronomical events and alignments. Starting at about 300 BCE the Greek and Babylonian astronomy began to influence the Egyptian astronomy.

**The Greeks.** Much of the astronomy from the Greeks was adopted from the Babylonians before 300 BCE. The constellations were often changed to reflect Greek mythology and gods.

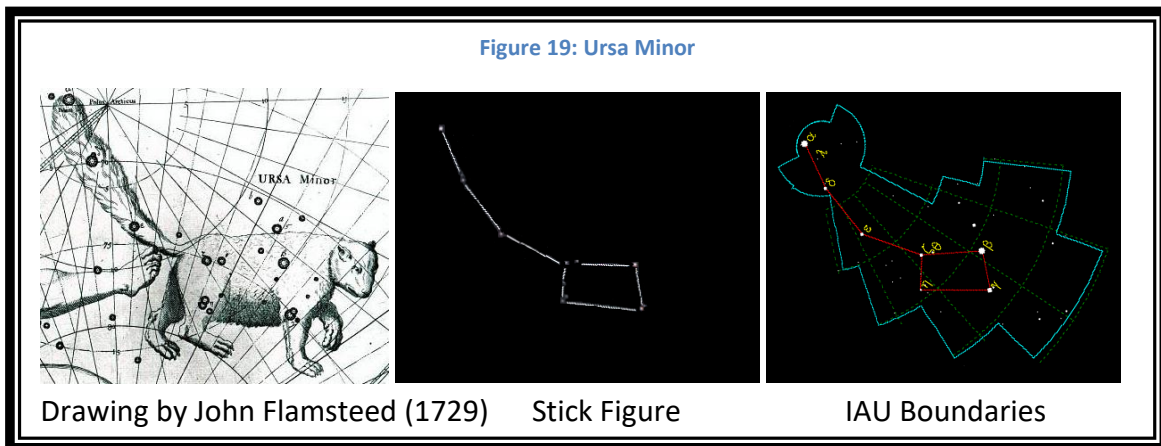
**The Romans.** Roman astronomy was very closely related to the Greek astronomy. Constellations were again changed to reflect Roman mythology and legends.

**Arabians.** Between 700 and 1500 CE the Islamic world was making great strides in astronomy. This coincides with the Dark Ages in Europe. During this time, the Europeans were not progressing much in astronomy. Many of the star names in use today as well as some of the terminology can be traced to Islamic roots.

**The Modern Era.** Stars and constellations of the far south were not visible from northern Africa, Asia, and Europe. These constellations and stars were named by explorers from those areas that first travelled southward around 1600 CE.

*The International  
Astronomical Union  
(IAU) set the current  
list of constellations*

**Modern Constellations.** The modern constellations were defined by the **International Astronomical Union (IAU)** in **1922 CE**. There are officially **88** constellations defined. These constellations, although often represented by images or stick figures, actually occupy a region of the sky. The IAU defined the limits of those regions and the lines follow lines of Right Ascension and Declination.



**Note:** All of the stars within the IAU Boundaries are considered part of that constellation, whether they are part of the stick figure or not. Boundaries are along lines of Right Ascension and Declination.

**Note:** The IAU boundaries cover the entire sky. There will never be a need to change the existing constellations and we will never need more constellations.

*There are 88  
constellations.*

**Note:** The curved boundaries in the image on the right are due to the constellation being so close to the North Celestial Pole that the lines of Declination appear as curves.

## **Component 6 – Nothing is Perfect in Astronomy**

Perfection is a unique state. A circle is a unique case of the broad class of ellipses. A sphere is a unique case of the broad class of ellipsoids. Although it is possible with billions and billions of cases that one will sometimes approach these unique cases, they are rare and unexpected.

### **Planets**

According to the definition of Planet developed by the International Astronomical Union, the first requirement is to be massive enough to have gravity pull an object into a roughly spherical shape. But no objects in the universe are perfect spheres. Since all objects rotate, and since rotation creates a centripetal force of the material of the object, all objects tend to bulge slightly at the equator. Spheres become oblate spheroids.

### **Orbits**

A perfect orbit would be a circle. But during the formation of star systems collisions occur so things that might initially start out as a circle will evolve into an ellipse. Orbits of planets around stars, and moons around planets, are ellipses.

### **The Sun**

Aristotle believed that beyond the Moon all of the universe was perfect. When Galileo peered through his telescope and noticed that the Sun has dark areas on its face (sunspots), this showed that the Sun was not perfect. A perfect Sun would have a uniform color with no markings whatsoever.

## Component 7 – Space is Really Big!

Here on the planet Earth, with an average planetary diameter of 7,917.5 miles, we tend to measure things in miles and kilometers. And locally we measure in feet and inches, or meters and millimeters. But when we move out into space we have to have larger scales to work with. For example, the distance that light travels in a year is about 6 trillion miles (6,000,000,000,000) or 10 trillion kilometers. That is way too many zeros to keep track of. So in astronomy we refer to this distance as a light-year.

### Astronomical Distance Scales

- **Astronomical Unit.** This is the average distance from the Sun to the Earth. It is equal to 92,955,807.3 miles or 149,597,871 kilometers.
- **Light-Year.** A light-year is the distance that light travels in a vacuum in a year. It is equal to 5,878,499,810,000 miles or 9,460,528,400,000 kilometers.
  - **Note:** Although the term light-year contains the word year, which relates to time, a light-year is actually a unit of distance.
  - **Note:** Although the speed of light is an upper speed limit, light travels at different speeds through different materials.
- **Parsec.** A parsec is equal to 3.26163344 light-years, or nearly 3.3 light-years.
  - **Note:** This is the distance you would need to be from the Earth to see the Earth’s orbit around the Sun as 1 arc-second of angular distance.

*3.3 light-years = 1 parsec*

Table 4: Metric Conversion Factors

Unit	Conversion	Example
1 Terra... =	1,000,000,000,000 standard units	Terrasecond
1 Giga... =	1,000,000,000 standard units	Glgasecond
1 Mega... =	1,000,000 standard units	Megasecond
1 Kilo... =	1,000 standard units	Kilosecond
		Second
1 Standard Unit =	100 Centi...	Centisecond
1 Standard Unit =	1,000 Milli...	Millisecond
1 Standard Unit =	1,000,000 Micro	Microsecond
1 Standard Unit =	1,000,000,000 Nano...	Nanosecond

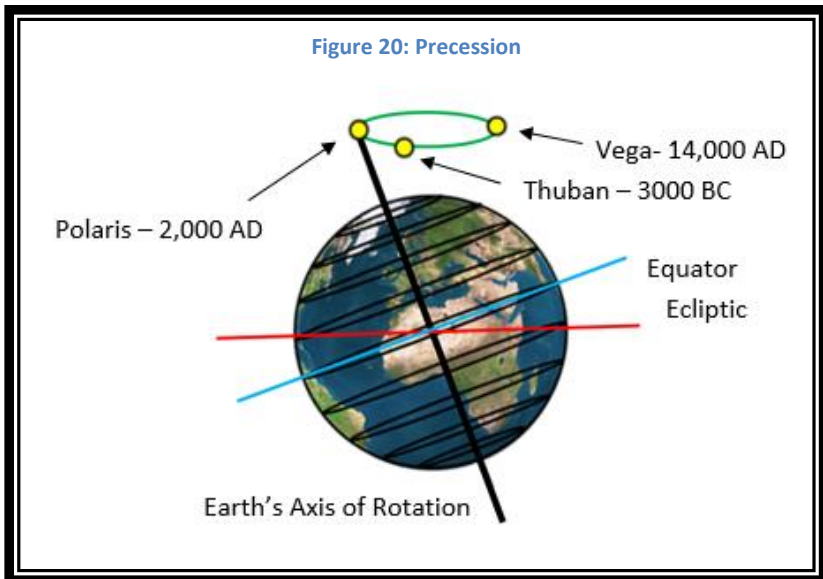


## Component 8 – Everything in Space is Moving

Einstein's Theory of Special Relativity indicated that there is no absolute frame of reference in the universe. You can relate to objects from your personal frame of reference, but it is no different than any other frame of reference.

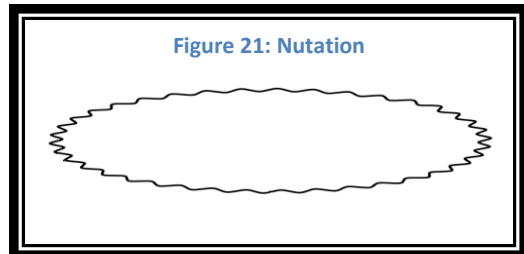
This component takes us directly to motion of us on Earth. Early people thought that the Earth was the center of the universe because it appears that we are not moving and that everything else is revolving around us. This is not the case.

**The Motions of the Earth.** In an airplane, travelling at 550 miles per hour at 35,000 feet in the air, if there is no turbulence, and if the window shades are closed, we would feel the same motion that we would feel sitting on the ground at the gate. But on take-off and landing, we feel the changes in velocity (acceleration and deceleration).



There are many motions for which people on the Earth experience no accelerations or decelerations, which include the following:

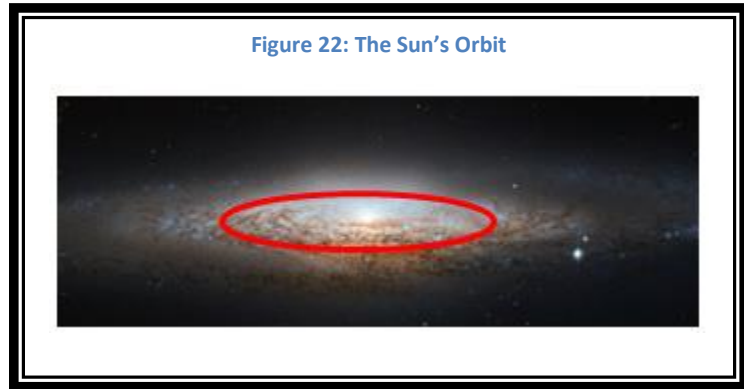
- **Earth's Rotation.** Every 24 hours people on the Earth rotate around the Earth's axis.
- **Earth's Revolution.** Once a year the Earth completely revolves around the Sun.
- **Precession.** Every 26,000 years the Earth's pole rotates around its center of Precession. The angular radius of this Precession is roughly 23.5 degrees. This is the same type of motion that you see on a top as it wobbles as it is slowing down.



*Precession – each turn takes 26,000 years*

- **Nutation.** There is also a small change in the axial tilt of the Earth from year to year. This is called Nutation. The principal sources of Nutation are the Sun and the Moon. The term having the largest effect has a period of 6798 days and is caused by the Moon.

- **Galactic Rotation.** The Sun is orbiting the center of the Milky Way Galaxy. One orbital revolution takes roughly 250 million Earth years.



- **The Sun's Orbital Oscillations.** As the Sun orbits the center of the Milky Way Galaxy there is also an up and down motion. This oscillation has a period of about 35 million years.



- **Galactic Attraction.** But even Galaxies are in motion relative to one another. The Andromeda Galaxy is approaching the Milky Way Galaxy at a speed of roughly 250,000 miles per hour. Since there is no absolute frame of reference, this means that to creatures in the Andromeda Galaxy, we are approaching them at 250,000 mph.
- **Location on Earth.** An observers latitude affects the times of sunrise and sunset. On the Earth's equator the lengths of days and nights change slightly during the year, but at the north and south poles, the day-night cycle becomes quite extreme due to the tilt of the Earth and its orbit around the Sun. There are many days when the Sun does not set.
- **And there are many more...** These are some of the many motions that we are experience living on the Earth.

## Component 9 – Motions of the Earth

Humans measure the passage of time. We measure based on the motions of the Earth, the Sun, and the Moon. Motions discussed in Component 9 have a direct effect on time measurements on Earth.

### Sidereal Time

As we discuss different time measurements, there are often two different values depending on which bodies

are used to determine the cycle. One of the terms is called **Sidereal**. These terms are based on the positions of the relatively fixed locations of distant stars. An easy way to remember this is the REAL in Sidereal. Since the distant stars don't appear to move much in our lifetime, their locations are essentially fixed in space: these are the REAL coordinates. The other term used relates to the specific bodies that are involved: Tropical Year, Synodic Month, and Solar Day.

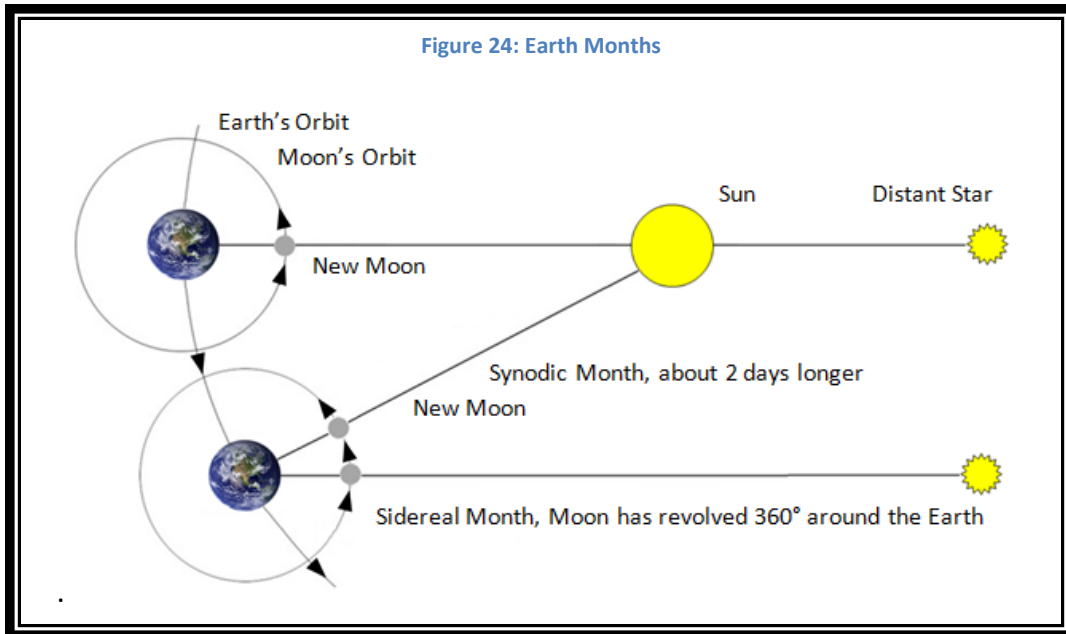
*Sidereal relates to the position of the stars*

### Years

The Earth is orbiting the Sun. Due to our axial tilt, there is a point each year when the Sun appears as far above the equator as it gets. If we measure the time from one of these points to the next, we measure a **Tropical Year**. This is the time required for the Earth to experience the four seasons. But due to the Earth's Precession, we are slowly changing our orientation towards the stars. The **Sidereal Year** is the time it takes to return to the point where the stars are in the same location in the sky, about one year later. A Tropical Year is approximately 365 days, 5 hours, 48 minutes, and 45 seconds (or roughly 365.25 days). A Sidereal Year is 20 minutes and 24.5 seconds longer than the Tropical Year (or roughly 20.5 minutes longer).

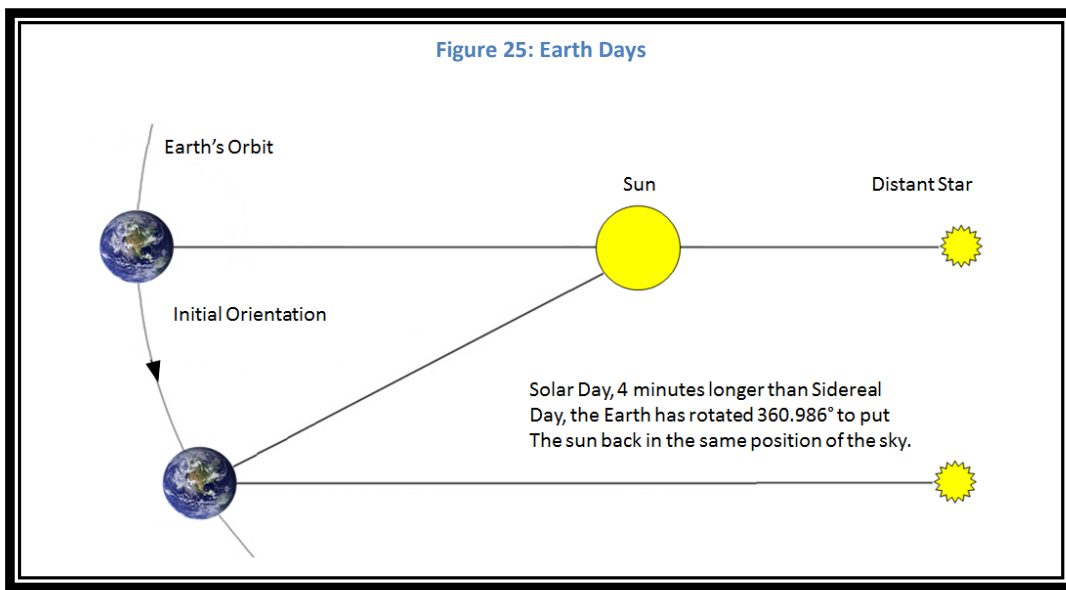
### Months

As the Moon orbits the Earth it makes one orbit in a month. The **Synodic Month** is the time it takes the Moon to return to the exact same phase and is dependent on the location of the Sun relative to the Earth and the Moon. This is the time it takes to go from one Full Moon, through the phases, and back to the next Full Moon. A Synodic Month is on average 29 days, 12 hours, 44 minutes, and 2.8016 seconds (or roughly 29.5 days). A **Sidereal Month** is the time required for the Moon to return to the same Right Ascension in the sky as it was the previous month. A Sidereal Month is 27 days, 7 hours, 43 minutes, and 11.5 seconds (or roughly 27.5 days). The Sidereal Month is about 2 days shorter than the Synodic Month. This difference is due to the fact that the Earth is moving in its orbit around the Sun while the Moon is orbiting the Earth.



## Days

As the Earth rotates on its axis, sometimes we are facing the Sun and sometimes we are facing away from the Sun. A **Solar Day** is defined as the time it takes for the Sun to go from directly south on one day to directly south the next day (solar transits). A **Sidereal Day** is the time it takes a star to go from directly south on one day to directly south the next day. But during that day, the Earth has moved about 1 degree around the Sun. A Sidereal Day is 23 hours, 56 minutes long. The Solar Day is about four minutes longer and is our 24-hour day.



## Seasons

As the Earth revolves around the Sun, the Earth's axis remains pointed at the same point in the sky.

Currently that point is very close to the star Polaris in Ursa Minor.

This means that some of the time the axis is tilted in the direction of the

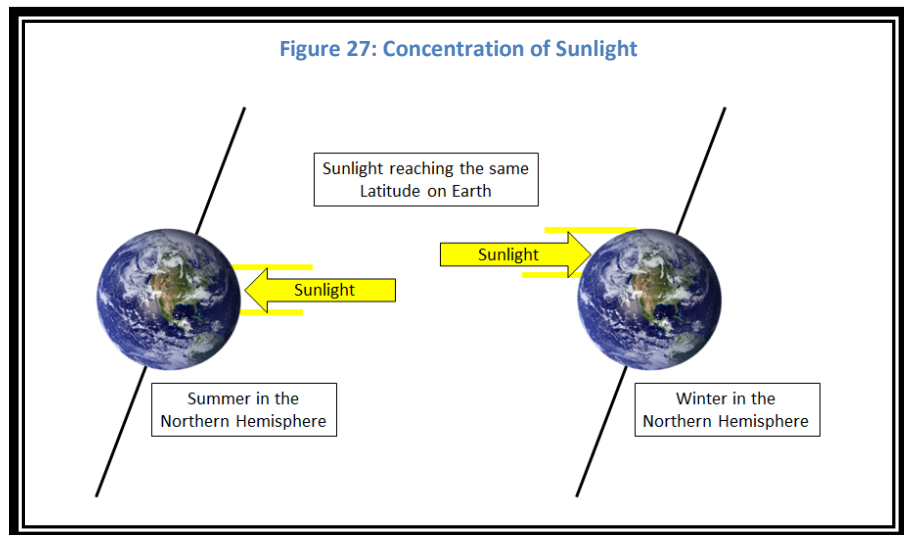
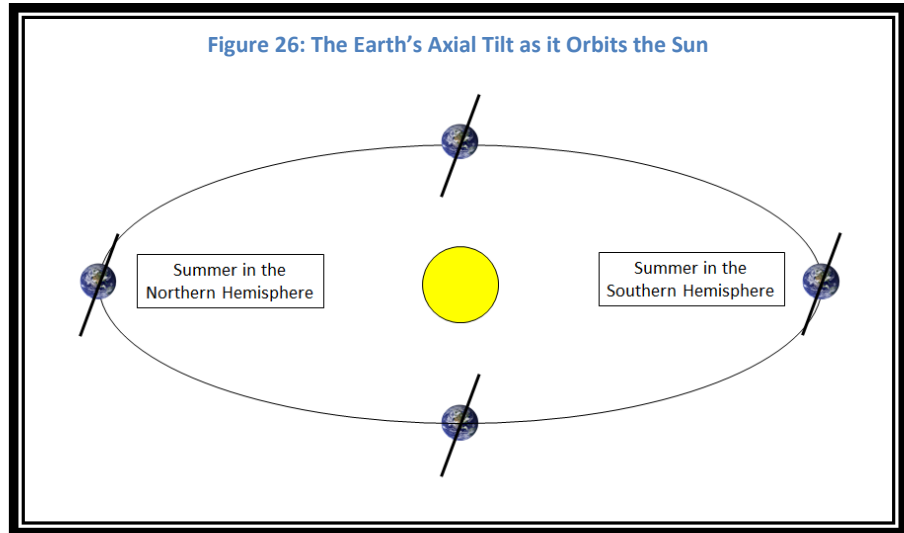
Sun, and sometimes it is tilted away from the Sun. (Figure 26) When your hemisphere is pointing towards the Sun, you experience summer. When your hemisphere is pointing away from the Sun, you experience winter.

On the Earth's equator, this means sometimes the Sun is north of an observer and sometimes the Sun is to the south. Throughout the year though, the Sun is close to overhead and the amount of sunlight reaching the ground is constant throughout the year. As the latitude of an

observer increases and moves away from the equator, the changes are more significant. Light rays from the Sun are more concentrated when the sun is higher in the sky and they are spread over a larger area when the Sun is lower in the sky. (Figure 27)

The Summer Solstice is the time of year when

the Sun is at the highest point north of the equator. The Winter Solstice is the time when the Sun is at the lowest point south of the equator. The Vernal Equinox and the Autumnal Equinox are the two times when the Sun crosses the equator.



## Component 10 – Lunar Phases

Each Synodic Month, the moon orbits the Earth. Sometimes it is between the Earth and the Sun, and sometimes it is on the opposite side of the Earth from the Sun. As it travels around the Earth we see sunlight on the side of the Moon that is facing the Sun, but usually the sunlit side is not facing the Earth. As a result we see different amounts of the sunlit face. This is what produces the phases of the Moon that we see.

### Tidally Locked

Over billions of years, the moon has been tugging on the Earth

*The Moon rotates in exactly the same time as it takes to revolve around the Earth*

with its gravity. On the Earth, this causes tides in our oceans. On the Moon, this has slowed the Moon's rotation. Currently the Moon is **Tidally Locked** to the Earth. This means that its rotational period is equal to the time it takes to complete one orbit around the Earth. As it moves around the Earth, it rotates just enough to keep one side facing the Earth all the time.

This tugging on the Moon is increasing its speed in its orbit. This has the effect that the Moon is moving away from the Earth at a rate of about 1.48 inches per year.

Just as the Moon's rotational period slowed down to tidally lock the Moon to the Earth, the same effect is happening to the Earth's rotational speed. It is slowing down. But we will likely never become tidally locked to the Moon. There are two reasons for this:

1. As the Moon moves away from the Earth, the effect decreases.
2. In about three billion years the oceans will boil away. When this happens the effect will further lessen since it is largely caused by the ocean tides on Earth.

### Cause of the Phases

Phases are caused by the alignment of the Sun, Moon, and the Earth. When the side that is facing the Sun is lit, the side facing away from the Sun is dark. As the Moon orbits the Earth, the lit side is sometimes the same side facing the Earth. This is the Full moon. About two weeks later, the dark side is facing the Earth. This is the New Moon. During the month we see less or

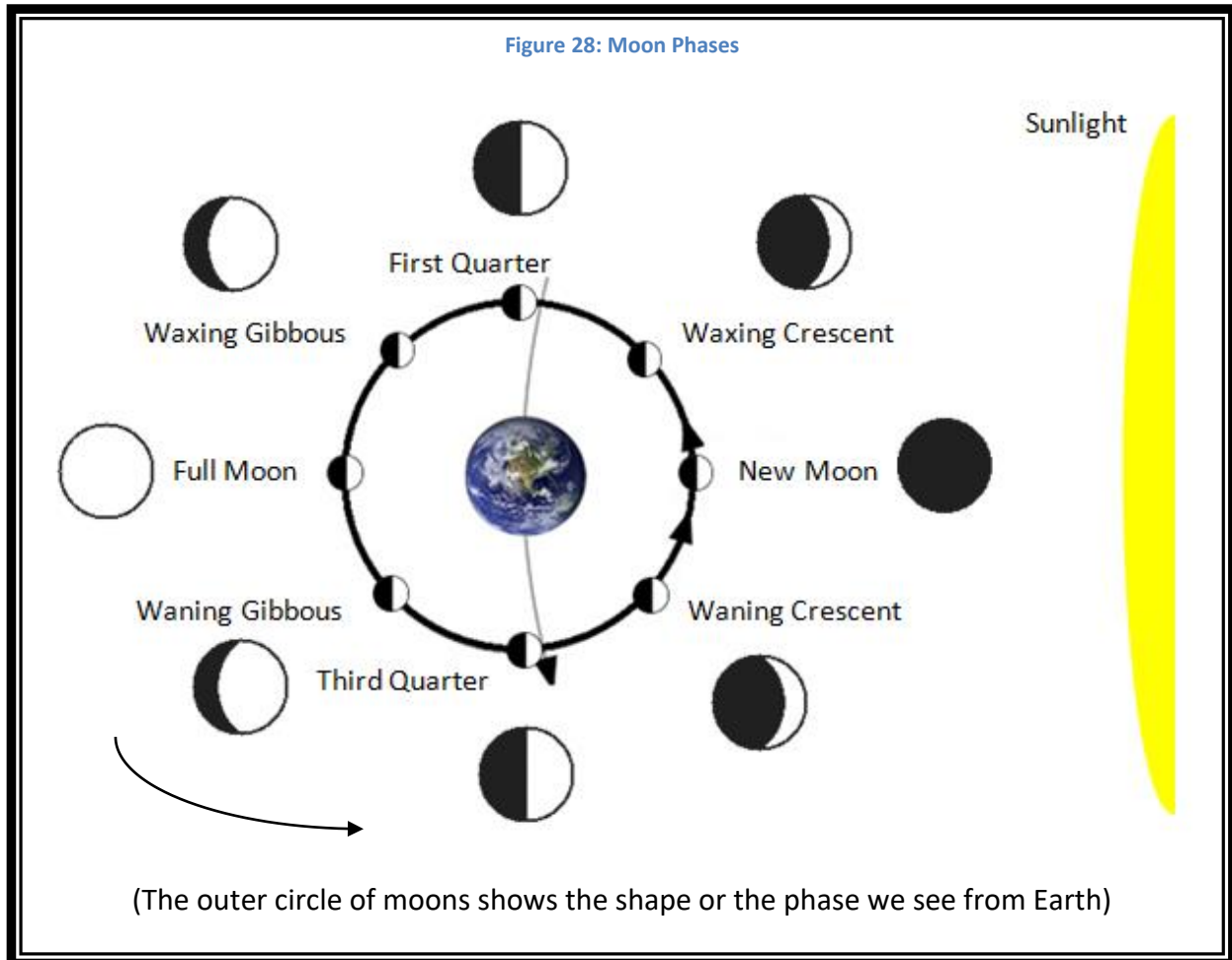
#### *The Moon's Phases:*

1. *New Moon*
2. *Waxing Crescent Moon*
3. *First Quarter Moon*
4. *Waxing Gibbous Moon*
5. *Full Moon*
6. *Waning Gibbous Moon*
7. *Third Quarter Moon*
8. *Waning Crescent Moon*

more of the Moon's lit side depending on where the Moon is in its orbit around the Earth.

**Waxing** – increasing in size. Starting at New Moon, the moon is waxing until it reaches the Full Moon. This includes the phases of **Waxing Crescent**, **First Quarter**, and **Waxing Gibbous**.

**Waning** – decreasing in size. Starting at the Full Moon, the Moon is Waning until it reaches the New Moon. This includes the phases of **Waning Crescent**, **Third Quarter**, and **Waning Gibbous**.



From our perspective on Earth, the Quarter Moons are half illuminated. The term Quarter relates to the monthly lunar cycle. If you consider the cycle from New Moon until the next New Moon, the Quarter Moons are a quarter of the complete cycle. The Full Moon is really the Second Quarter Moon, but we call it the Full Moon.

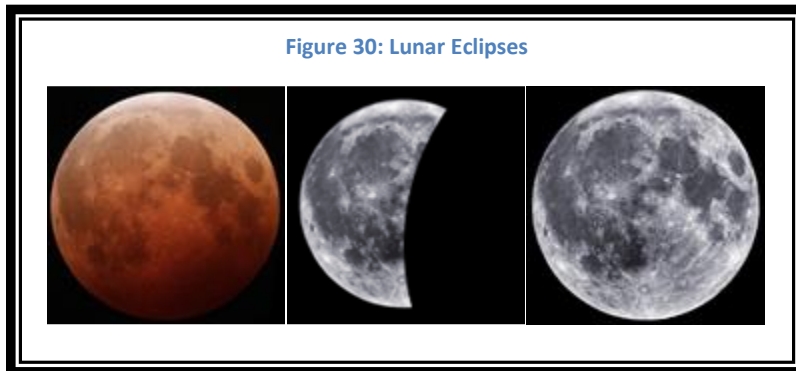
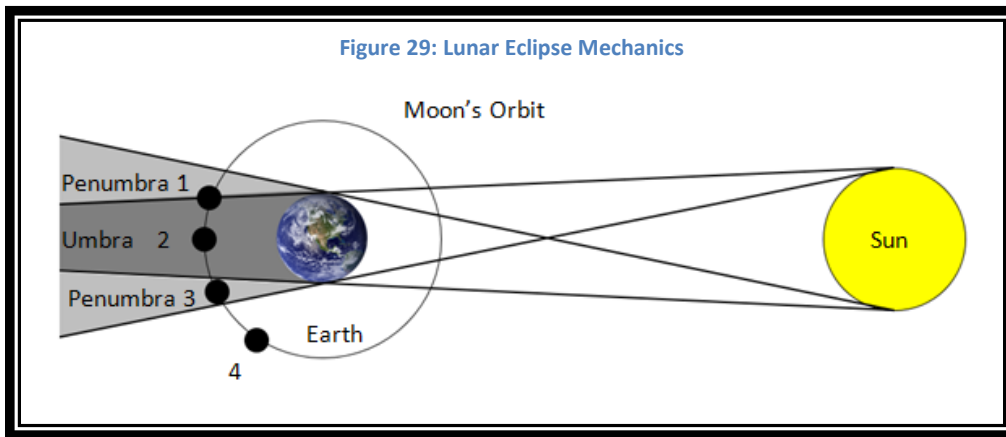
## Component 11 – Eclipses

### Eclipses

An eclipse is when one object moves in front of another object and blocks the light from the Sun. The Earth is involved with two categories of eclipses: **Lunar Eclipses** and **Solar Eclipses**.

**Earth's Shadow.** The Earth's Shadow has two parts: the **Umbra** and the **Penumbra** (see Figure 29). If an object is inside the Umbra, the Earth is blocking all sunlight from reaching the object. If an object is in the Penumbra then the Earth is partially covering up the Sun and some of the Sun's light is still reaching the object.

**Lunar Eclipses.** Lunar Eclipses are caused when the Moon moves into the shadow of the Earth (see Figure 29). Sunlight is blocked from reaching the Moon by the Earth. The Moon is **Full**.



There are three types of Lunar Eclipses: **Total Eclipse**, **Partial Eclipse**, and **Penumbral Eclipse**. A Total Lunar Eclipse (position 2 in Figure 29 and left side of Figure 30) is when the Moon moves completely inside the Umbral shadow of the Earth, so

the entire Moon does not receive any light from the Sun. A Partial Lunar Eclipse (position 1 in Figure 29 and center of Figure 30) is when the Moon is only partially in the Umbral shadow of the Earth. Part of the Moon receives no sunlight, but the rest of the Moon is only partially blocked by the Earth and some sunlight reaches that part of the Moon. A Penumbral Lunar Eclipse (position 3 in Figure 29) is when the Moon is in the Penumbra shadow of the Earth, but



is not in the Umbral shadow at all. In this case the Moon appears darker than it usually is when it is Full, but the change is not obvious to the casual observer. There are also times when the Moon does not even enter the Penumbral shadow of the Earth (position 4 in Figure 29 and right side of Figure 30). At these times we see a normal Full Moon.

**Note:** Anyone on the Earth, who can see the Moon, can see the eclipse, no matter what type of eclipse it is. In fact even if you are elsewhere in space, if you can see the Moon then you can see it in Eclipse.

*Lunar Eclipses happen only during a Full Moon*

**Note:** When the Moon is in Total Lunar Eclipse, it is usually not black; it does not disappear. It usually turns red. This is because the red light from the Sun, although not reaching the Moon directly, does bend through the Earth's atmosphere and reaches the Moon indirectly.

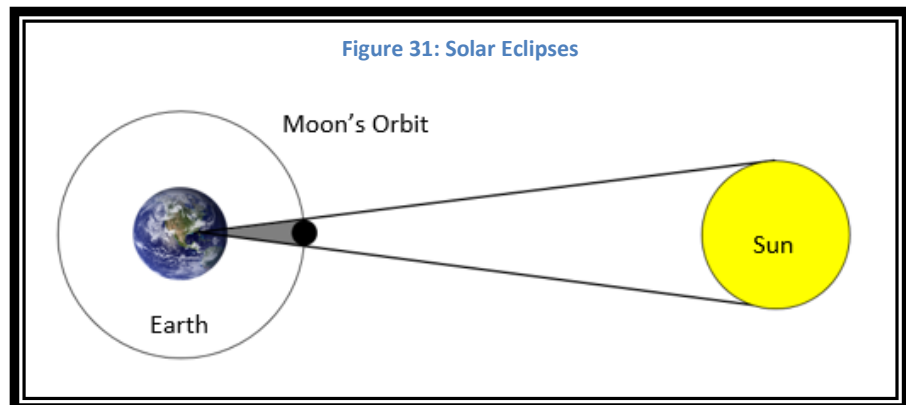
**The Danjon Scale.** The **Danjon Scale** provides a means to measure the darkness of an eclipse.

Table 5: Lunar Eclipses

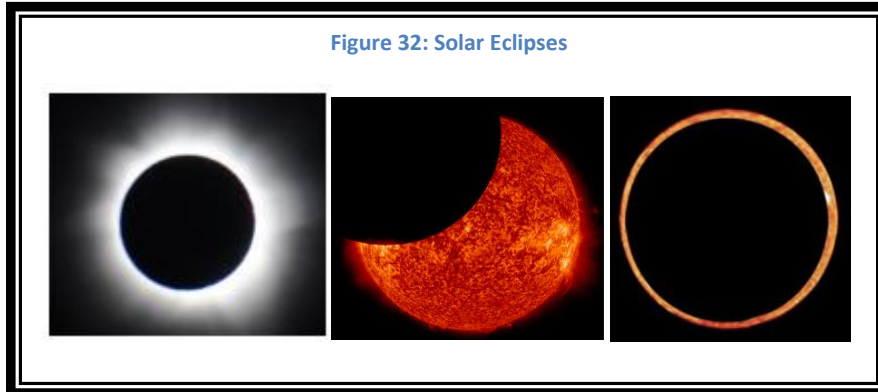
- 0 - Very dark eclipse: The Moon is almost invisible, especially at mid-totally.
- 1 - Dark Eclipse, gray or brownish in coloration: Details are distinguishable only with difficulty.
- 2 - Deep red or rust-colored eclipse: There is a very dark central shadow, while the outer edge of the umbra is relatively bright.
- 3 - Brick-red eclipse: The Umbral shadow usually has a bright or yellow rim.
- 4 - Very bright copper-red or orange eclipse: The Umbral shadow has a bluish or very bright rim.

**Solar Eclipses.** Solar Eclipses are caused when the Moon moves between the Earth and the Sun. The Moon's shadow reaches the Earth and you have a Solar Eclipse (see Figure 33). The Moon is **New**.

Figure 31: Solar Eclipses

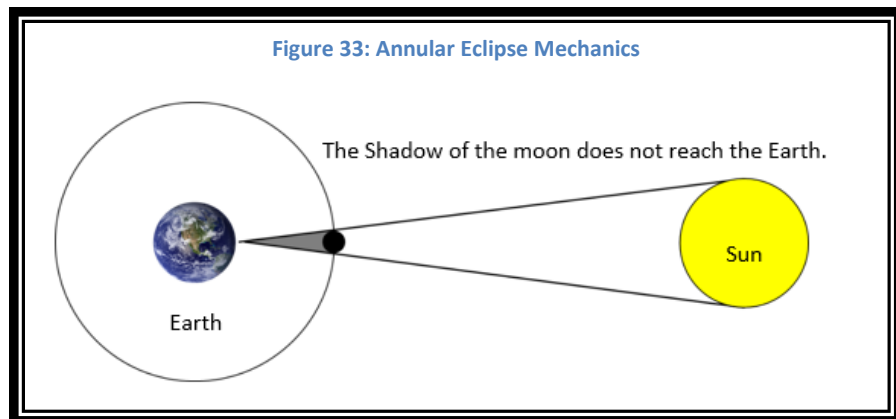


There are three types of Solar Eclipses: **Total Eclipse**, **Partial Eclipse** and **Annular Eclipse**. A Total Solar Eclipse (see Figure 32) creates a shadow that follows a narrow path across the face



of the Earth. If you are within that path you will see the Total Solar Eclipse. If you are outside of that path, but not too far away you will see a Partial Solar Eclipse. Annular Solar Eclipses are a special case. The Moon and the Earth both orbit

in ellipses, not in circles. This means that some of the time they are closer together and sometimes farther apart. When an object is closer it appears larger. When it is farther away it appears smaller. This means that the Sun may



be too large for the Moon to completely cover, or the Moon may be too small to cover the Sun. In either case, instead of a Total Solar Eclipse, you will see an Annular Solar Eclipse (see Figure 33). There will be a ring of Sun (an annulus) around the moon.

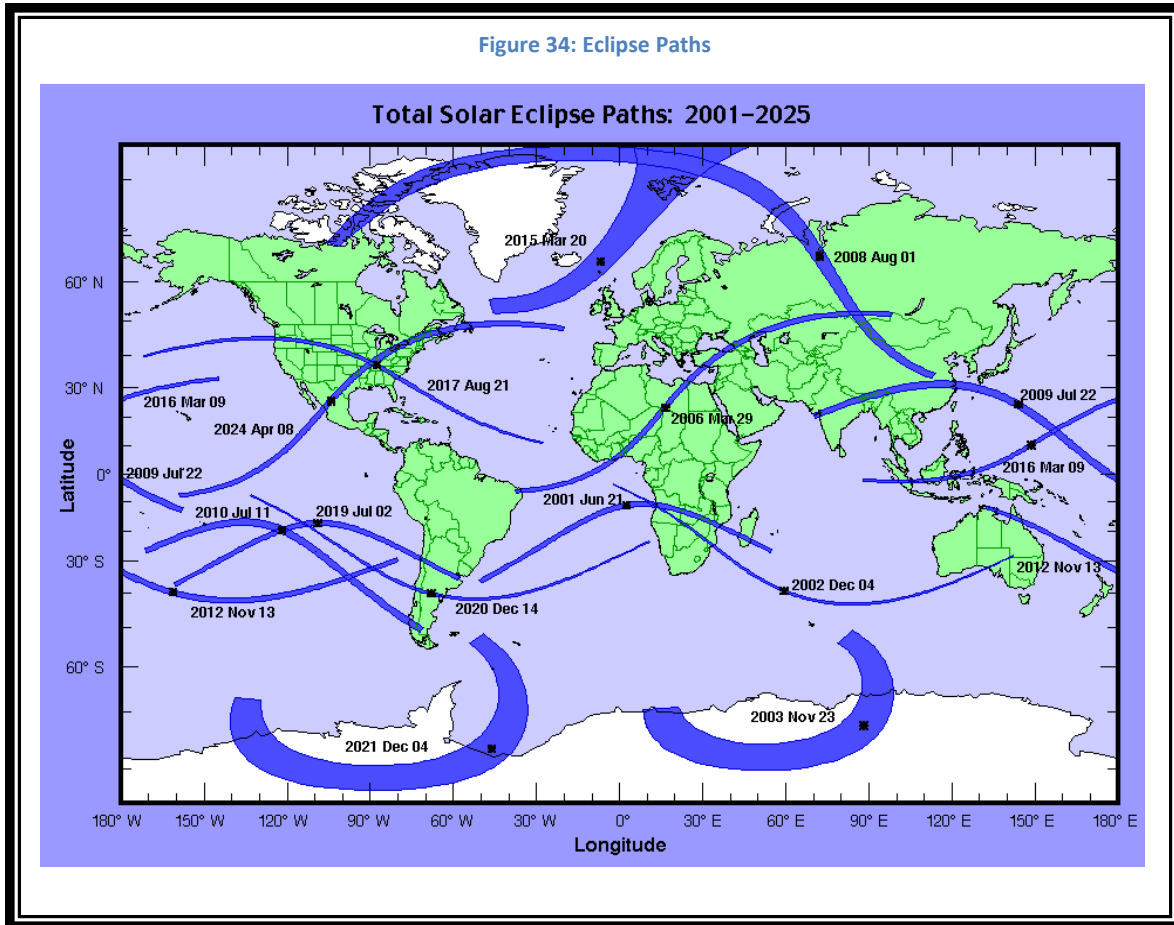
### **Total Solar Eclipse of August 2017**

For information on the next Total Solar Eclipse that will be in North America, go to NASA's Solar Eclipse page:

<http://eclipse.gsfc.nasa.gov/SEplot/SEplot2001/SE2017Aug21T.GIF> (Cut and paste this address into an internet browser.)

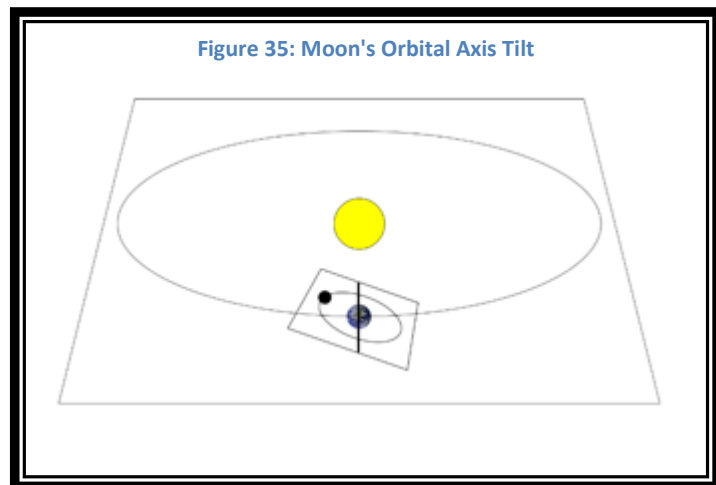
*Solar Eclipses happen  
only during a New Moon*

**Total Solar Eclipses – Recent and Near Future**



**Perfect Alignment**

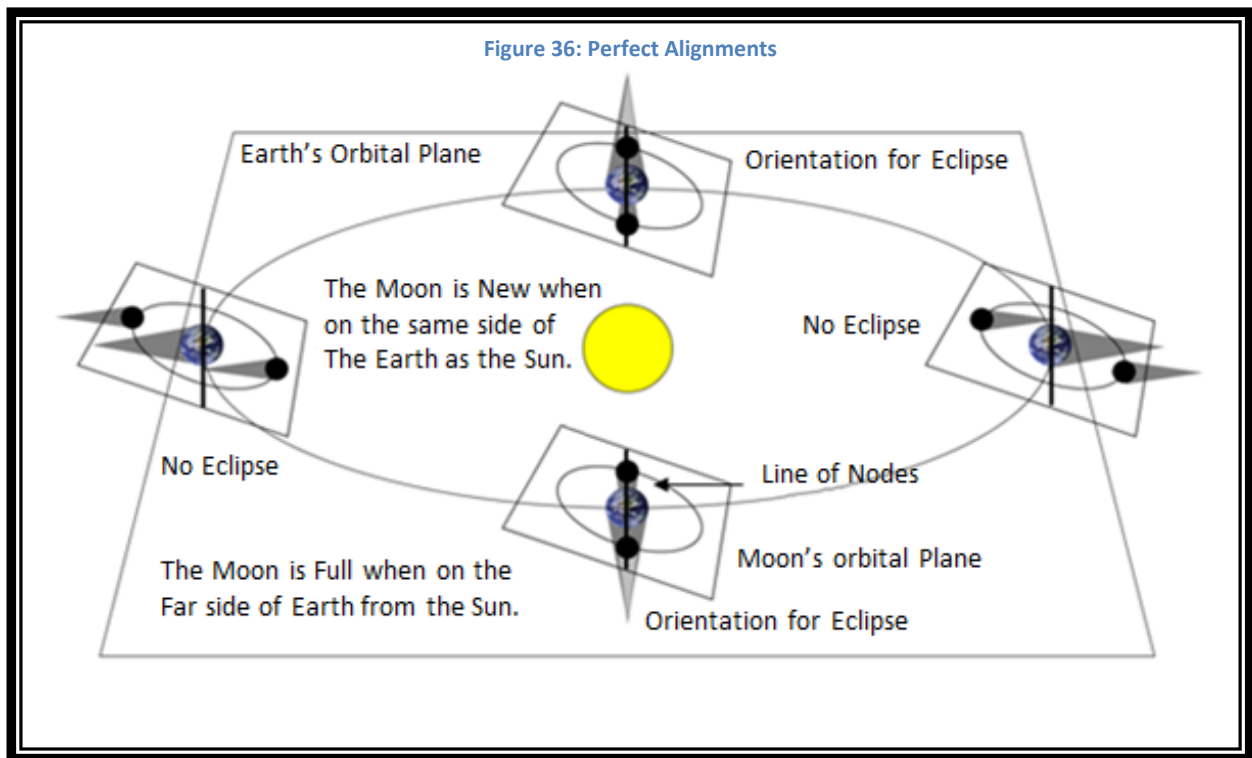
The Moon’s orbital plane is not the same as the Earth’s orbital plane (see Figure 35). Only when the Sun, the Moon, and the Earth are in a straight line will you see an eclipse. The Ecliptic is defined as the plane of the Earth’s orbit. By definition the Sun and the Earth are always in that plane. But the Moon’s orbital plane is inclined about 5 degrees from the Earth’s orbital plane. Eclipses occur where the two orbital planes intersect (see Figure 36),



and only when the Moon is in a place in its orbit that is crossing that intersection. These two events are called lunar nodes. The ascending node is where the Moon is moving from south of the ecliptic to north of the ecliptic. The descending node is where the Moon is moving from north of the ecliptic to south of the ecliptic.

**Note:** This means that you will see Lunar Eclipses at the most twice each year, when the Line of Nodes points to the Sun. This is also true for Solar Eclipses. There will be at most two per year.

*Lunar or Solar Eclipses occur a maximum of twice each year*



## \*\*\* SECTION II. ASTRONOMY – HISTORY



Photo by Citypeek



Photo by Kristian H Ressel

A more thorough discussion of astronomical history is available in [Appendix 6 – The History of Astronomy](#).

## Component 12 – The Science of Early People

### Why the Stars?

It all began so long ago that there are no records. Early people, with no modern technology, but they were beginning to learn new skills; Farming and Sailing.

If you lived somewhere like the Nile River valley, you would be washed out by floods each year. There was a flooding season, but you had no calendars, so you had no way to know when it was going to happen. If you planted your crops before the flood, the seeds would be washed away. If you wait too long, you may not have enough time for your seeds to grow and produce food. There were locusts too. You needed to know when they were likely to arrive so you can harvest your crops before they arrive. Too early, and you will get less to eat. Too late, and the locusts will eat your harvest. Knowledge of the stars was useful in **Agriculture**.

If you stay near shore when sailing, then you are probably ok, but if you venture far from shore you need to know where you are. Without it, you may run out of food and water before you reach land or the winds may carry you far off course and you could land in an unfriendly land. Knowledge of the stars was useful in **Navigation**.

The solution is in the stars. Early people, sitting around the campfire would notice rhythms in the movement of the stars. A few things move separately (the moon, the planets), but most of the stars behaved and moved like clockwork. They could be used as a calendar or a map.

### Early Records of Tracking Movements in the Sky

The earliest records date back to around 1800 BCE and are from the Babylonians (in current day Iraq). Initially, the observations focused on the Sun, Moon, and Venus; but later included Mercury, Jupiter, and Saturn as well. They were able to use this data to create predictions of their motions. The primary purpose of this study appears to have been for religious reasons. It is believed that early people used these early tools to more closely connect themselves to the greater universe.

### Early Structures for Reading the Sky

Early people found ways to build structures that they could use to predict the seasons. They worked with the tools they had and the materials on-hand and build astronomical tools. The study of these early structures is called Archeoastronomy. There are lists of these sites from all over the world.

**Stone Circles.** Initially, they would mark points in a circle that would enable them to watch for events in the sky. When these events happened they would know the seasons would be about to change. The easiest way for them to do this was to set stones on the ground in a big circle, sometimes with spokes. A good example of one of these is the **Bighorn Medicine Wheel** located atop Medicine Mountain near Lovell, Wyoming.



**Deciphering the layout.** Early people did not leave any instructions for their tools. Astronomers and historians have tried for many years to understand how they would have been used.

The large stone circle has a central circle and six smaller circles or cairns around the outside. These seem to have served as focal points and observation points.

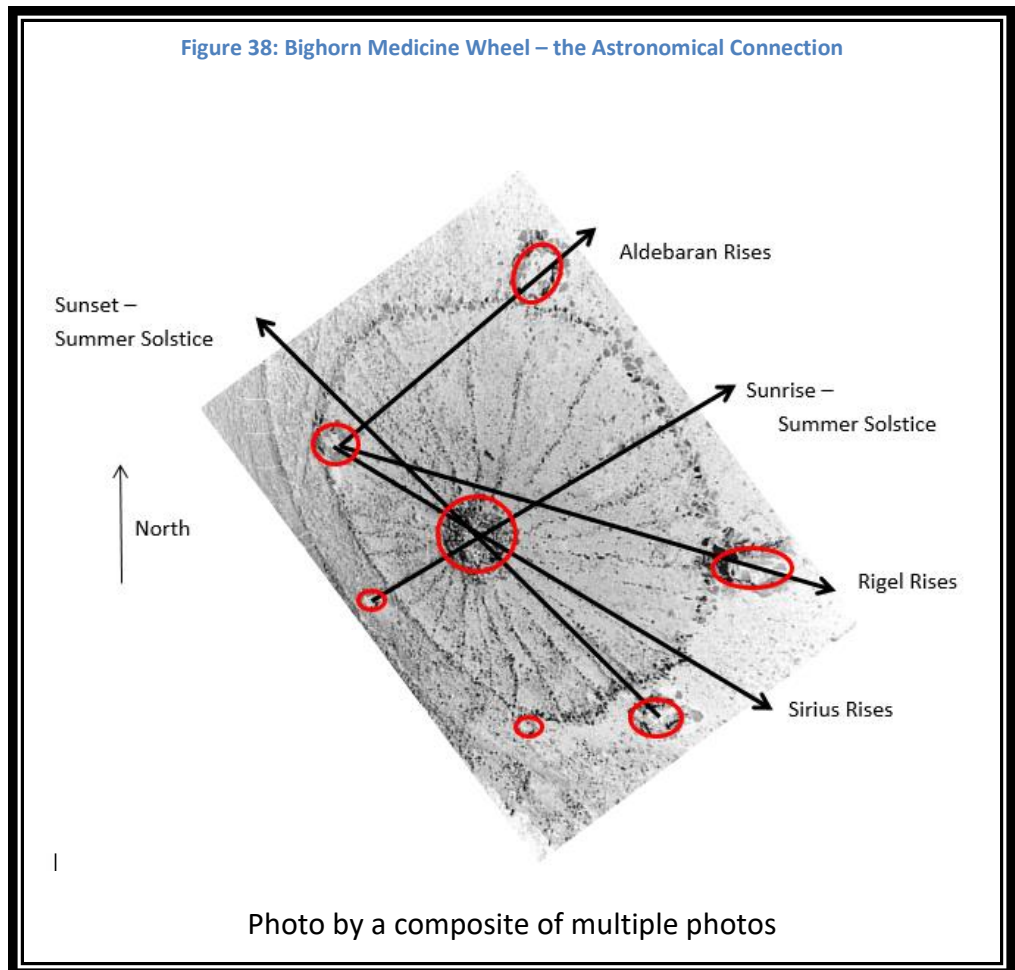


Figure 39: Stone Circle in Ireland



Photo by Ardfern

Figure 40: Stonehenge



Photo by Adrian Pingstone

There are also many stone circles in Europe and elsewhere in the world.

**Stonehenge.** In England, early people dragged huge stones many miles and set them in the ground in the form of a great circle. **Stonehenge** was built between 3000 BC and 2000 BC. It is amid a large collection of burial mounds and other prehistoric structures.

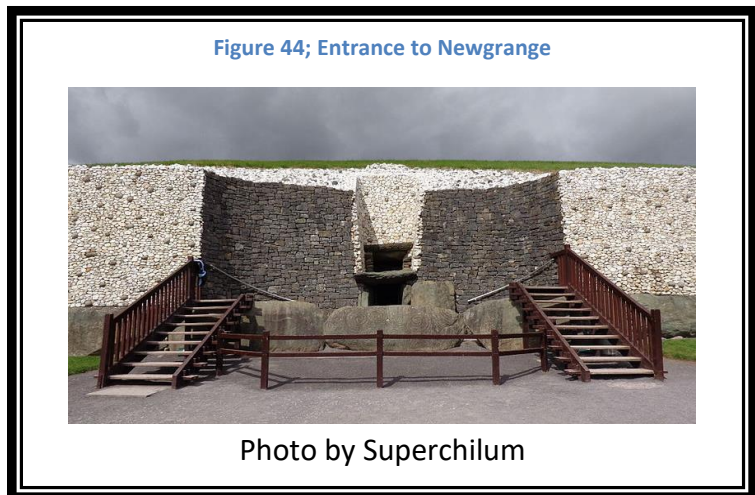
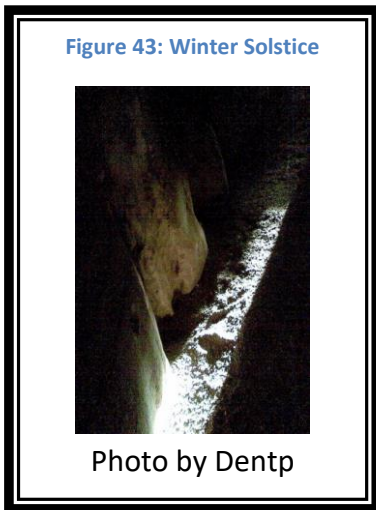
**El Caracol.** **El Caracol** is an astronomical observatory built at Chichen Itza by the pre-Columbian Maya civilization in Mexico. It was built around 906 AD. The tower is badly damaged, but of the 29 celestial events that were important to the Maya, 20 can be observed from the tower.



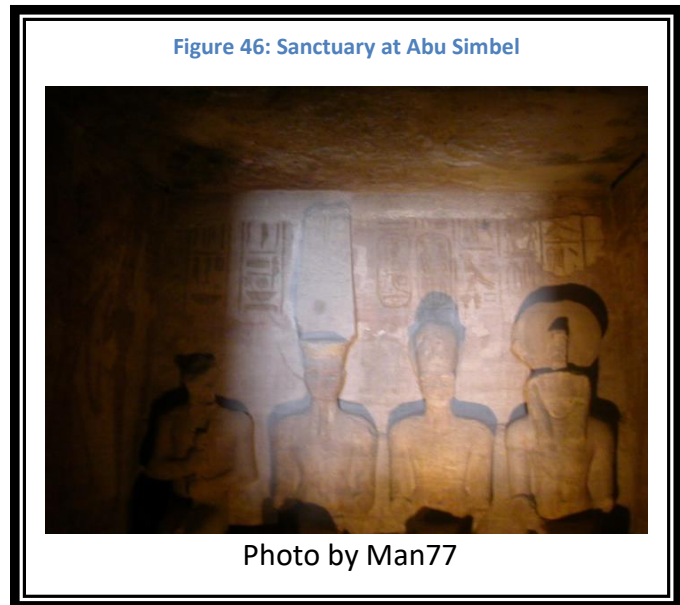
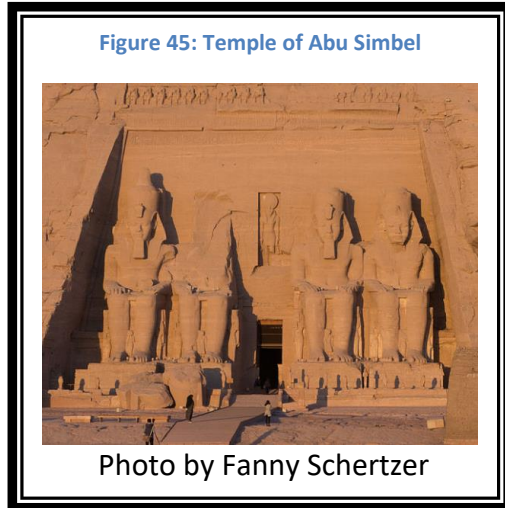
**Other Sites with an Astronomical Twist.** There are many other sites around the world where, although they may not have been observatories, their construction was based on astronomical phenomena. These were often related to the culture's mythology or religion.

**The Great Pyramids of Egypt at Giza.** These are burial chambers to the pharaohs. Their bases and some passageways are aligned to north and to celestial objects.

**Newgrange.** This is a burial mound in Ireland. The upper passageway is situated so that on the Winter Solstice sunlight will travel down the passageway and illuminate the burial chamber at the end.



**Temple of Abu Simbel in Egypt.** The temple is constructed such that on October 22 and February 22, the rays of the first rays of the morning Sun penetrate the sanctuary and illuminate the sculptures on the back wall, except for the statue of Ptah, the god connected with the Underworld, who always remained in the dark. The other statues are (from left to right) Amun Ra, Ramesses, and Ra-Horakhty.



*Early people built stone structures to tell the seasons for planting, harvesting, and when to expect the annual floods. Knowing the patterns and timing of the stars helped with navigation.*

## Component 13 – The Beginning of Scientific Thinking

If you do not have a scientific approach to analyze what you see, you do not have a complete scientific method. In the early days of science this limited people to two steps: Observe and Think About It.

### **Observe**

Humans have always observed the world around them. It would initially be to look for edible plants, game animals, shelter and water. As humans began to have more leisure time, they would have more time to think about what they see around them. When humans began to use language, they would be able to discuss the things they observe with others. When humans began using writing, they then had a way to keep a record of their thoughts and observations.

### **Think About It**

When you think about what you observe, you must try to fit what you see into your view of the world. If you see things you have never seen before, then you need to try to understand what you see. But, if you do not have a scientific method to analyze what you see, you only have the ability to apply what you know. This was the case for early scientists.

As early as 2900 BC thinkers were beginning to apply the principles of philosophy. Around 400 BC philosophy had evolved to the place where thinkers like Aristotle were trying to define the world around them including the science that would grow into astronomy.

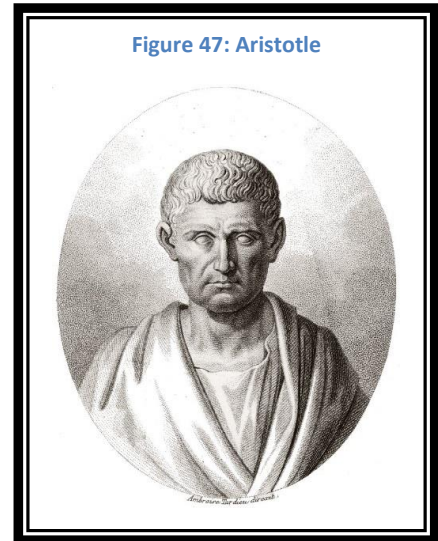
### **Early Scientists**

**Eudoxus of Cnidus (408-355 BC).** Eudoxus was a Greek astronomer, mathematician, and scholar. He created models of the universe. The Earth was a sphere at the center. To explain the moon's motion he needed three spheres: the outermost for daily motion, the second for monthly motion, and a third to explain the changes above and below the ecliptic. He had a similar model to explain the motions of the Sun including three spheres: the outermost for daily motion, then yearly motion, and a third for changes in Declination. The five visible planets (Mercury, Venus, Mars, Jupiter, and Saturn) each had models consisting of four spheres: the outermost for daily motion, motion through the signs of the zodiac, and two inner spheres to explain Retrograde Motion. Lastly there was a sphere for the distant stars. He is credited with being the first person to try to apply mathematical solutions to the observed motions of the heavens. Aristotle and Callippus were his students.

**Callippus (370-300 BC).** Callippus was a Greek astronomer and mathematician. He added 7 more spheres to the models of Eudoxus; 2 for the sun, 2 for the moon, and one for each of the inner planets: Mercury, Venus, and Mars. His observations of the Sun indicated that the seasons were different lengths which implied the Sun did not move at a constant speed along the ecliptic. He called this the solar anomaly. He created an accurate lunisolar calendar.

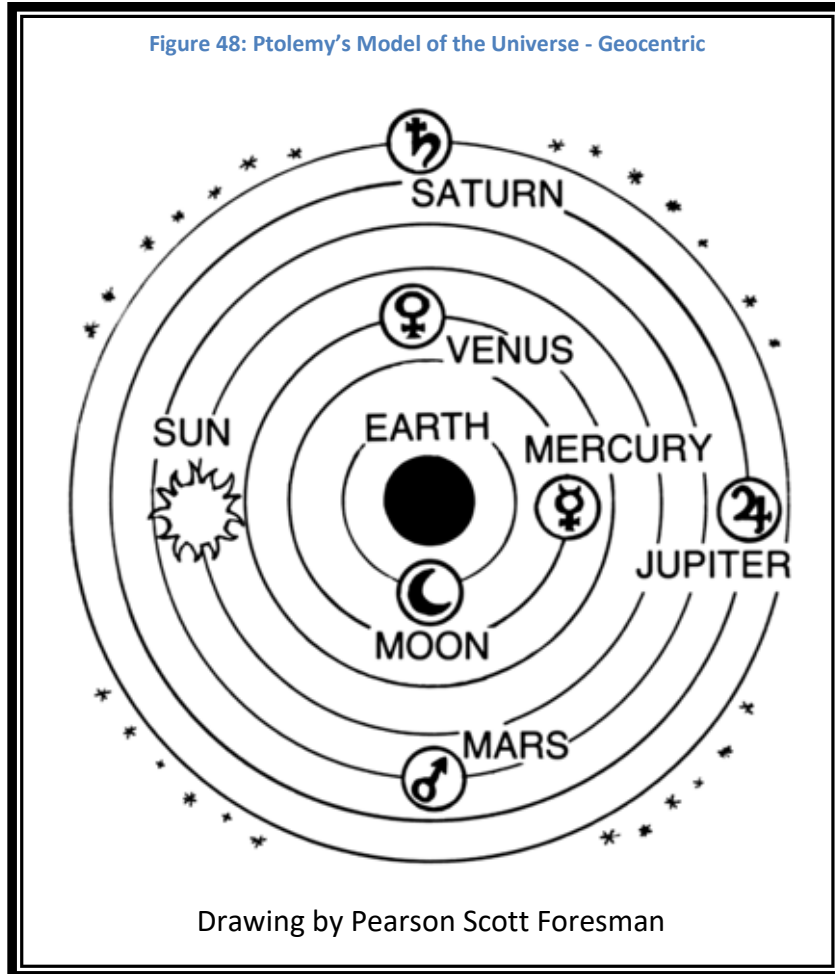
**Aristotle (384-322 BC).** Aristotle was a Greek Philosopher who wrote 8 books related to Physics. Some of his conclusions that relate to astronomy include:

- A void is not only unnecessary but leads to contradictions.
- Time is a constant attribute of movements and does not exist on its own but is relative to the motions of things. Time is defined as "the number of movement in respect to before and after", so it cannot exist without succession.
- He described the celestial bodies thus: the first things to be moved must undergo an infinite, single and continuous movement, that is, circular.
- The planets and stars, which have their source of motion within themselves (by virtue of aether), aspire to emulate the uniform circular motion of their particular mover. Thus captivated, their tireless performance is entirely the result of their own desire. This is one way in which the movers are said to be unmoved.
- He viewed the aether as a fifth element. It was divine and perfect.



These conclusions implied a number of things that would have an effect on how humans would view the universe for centuries. Some examples are:

- The heavens are **perfect** beyond the moon.
- The universe is filled with an **aether**. There is no vacuum.
- **Time** is unchanging as it marches forward.
- Everything travels in circles and spheres.
- The **earth** is the **center** of the Universe. (**Geocentric**, by **Ptolamy**)



*The Earth appeared to early humans to be the center of the universe. This is the Geocentric Model. It is wrong.*

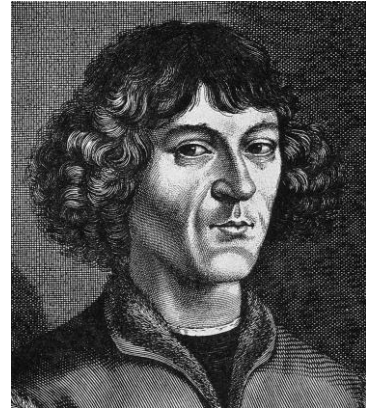
## Component 14 – A Scientific Approach is Born

For 2000 years the philosophy of Aristotle was dominating the science of astronomy. It was not until some brave scientists decided to challenge this philosophy based on new observations that the science of astronomy began to move ahead.

### Those Who Cleared the Field and Planted the Seeds

**Nicolaus Copernicus (1473-1543).** Copernicus did not create a heliocentric model of the solar system, but he is given much credit for popularizing it. He was a German mathematician and astronomer. His model put the Sun at the center with the planets orbiting the sun, and the moon orbiting the Earth. The problem with his model was he was unable to go beyond orbits being circles. His model was very bad at predicting future positions of the planets. This shortcoming played a major role in the delay of the acceptance of the heliocentric model

Figure 49: Nicolaus Copernicus



**Tycho Brahe (1546-1601).** Tycho Brahe was the best observer of all time who did not use a telescope. He was a Danish nobleman. His **observations** were done using a quadrant and he provided very accurate positional information for many stars and planets. His accuracy was typically within 1 arc-minute.

Figure 50: The Quadrant



Figure 51: Tycho Brahe



He also made observations of the Supernova in Cassiopeia in 1572.

**Johannes Kepler (1571-1630).**

Kepler was a great mathematician. His eyesight was so poor that he was not a very good astronomer. However, as an apprentice to Tycho Brahe, he eventually had access to the best observational **data** available. By using his mathematical skills, Kepler was able to determine the rules by which the planets appeared to behave.

Figure 53: Johannes Kepler



*Kepler used Tycho Brahe's data to determine the Laws of Planetary Motion*

Figure 54: Brahe's Model of the Universe

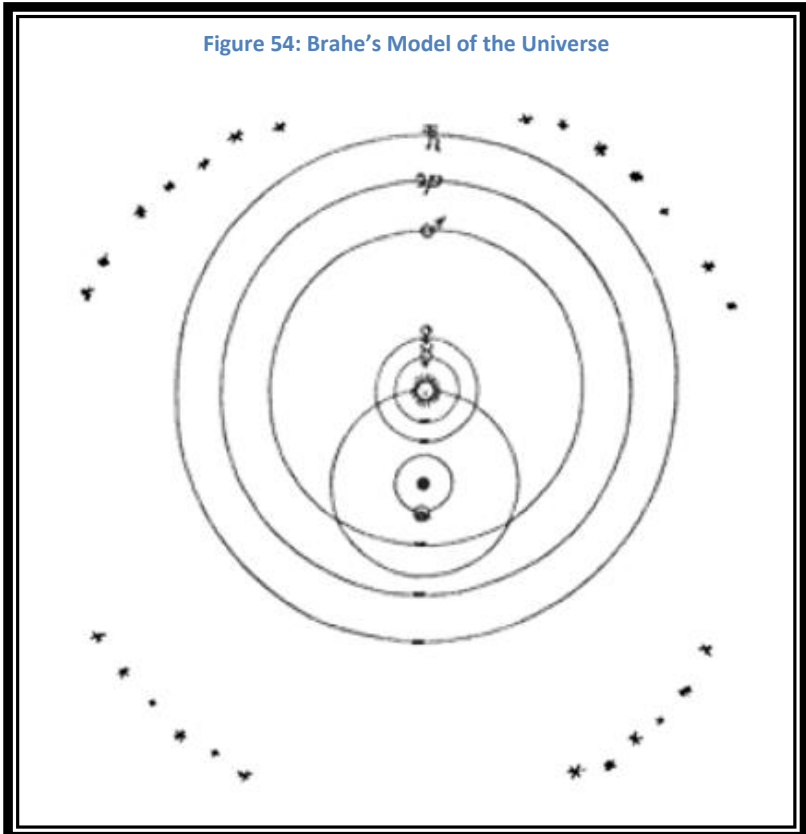
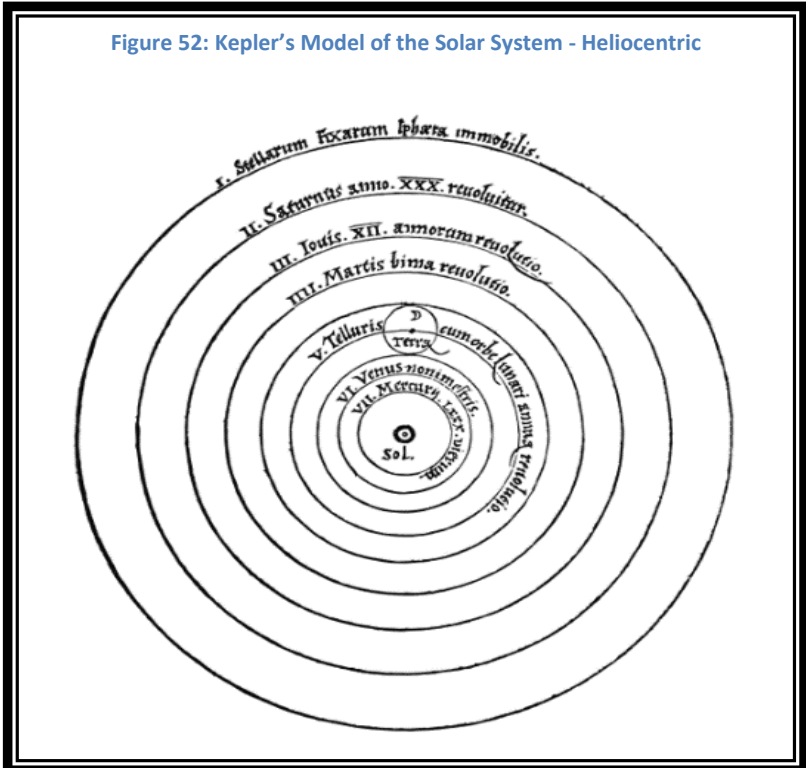


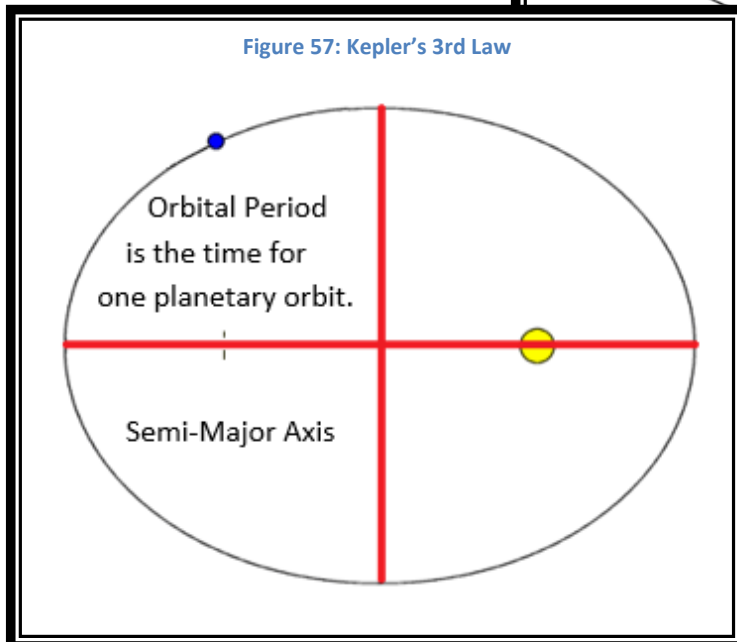
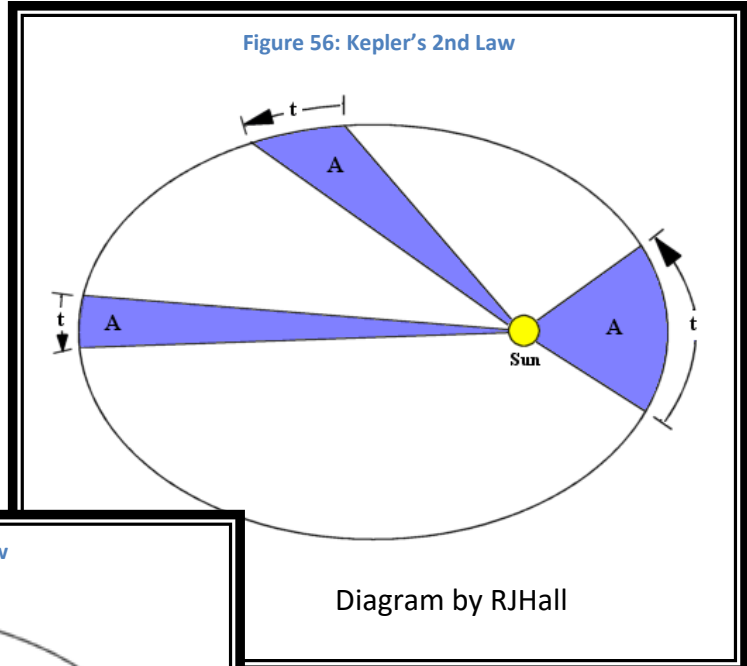
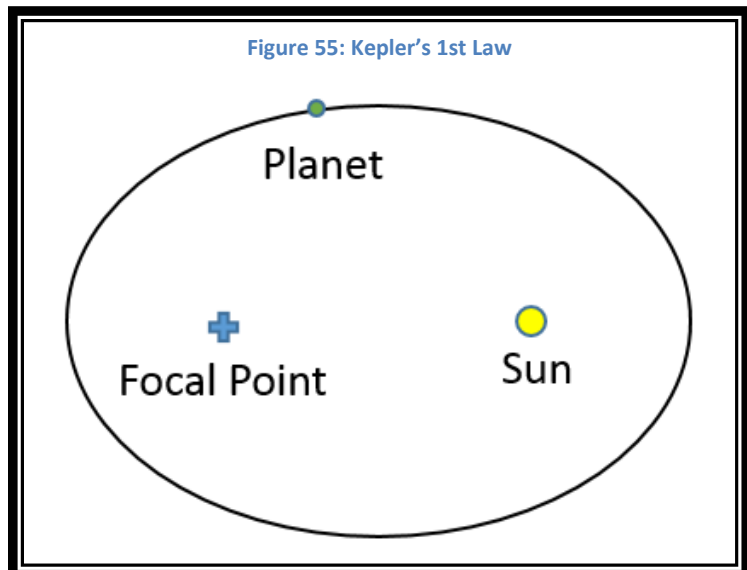
Figure 52: Kepler's Model of the Solar System - Heliocentric



Kepler's Laws are:

1. Planets move in ellipses, not circles, and the Sun is at one focus.
2. A line connecting the planet to the Sun will sweep out an equal amount of space in an equal amount of time.
3. The square of the orbital period of a planet is proportional to the cube of the semi-major axis of its **orbit**.

Kepler's Laws now provided a basis for a heliocentric model of the solar system that was accurate enough to beat the accuracy of the geocentric models, and it was simple and elegant.



*The Heliocentric Model places the Sun at the center of the Solar System*

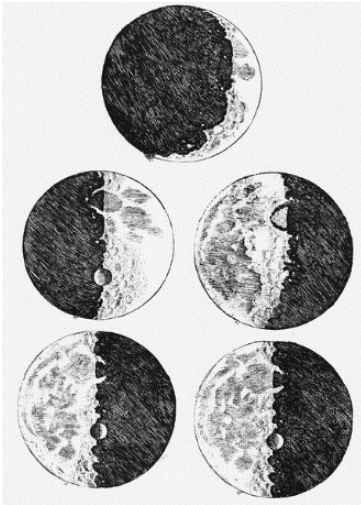


**Galileo Galilei (1564-1642).** Based on the telescope invented in 1608 by Hans Lippershey (1570-1619) in the Netherlands, Galileo was able to develop his own telescope. The myth of the creation of Lippershey's telescope is that his children were in his spectacle shop, and while playing with two lenses they were able to see things across the street much more clearly. Galileo, upon hearing of the invention created one.

*Galileo observed:*

- *Sunspots*
- *Jupiter's Moons*
- *Lunar Mountains*
- *Venus' Phases*

Figure 59: Galileo's Moon



Sketch by Galileo

Galileo is given credit for being the first person of record to point the new telescope towards the heavens and to record what he saw. Specifically he observed:

- Sunspots on the surface of the sun.
- Moons orbiting Jupiter.
- Mountains on the moon.
- Phases of Venus.

These observations provided significant evidence that much of what was believed in the geocentric model of the universe and based on

Aristotle's conclusions was incorrect. The moon's orbiting Jupiter proved that not all objects revolved around the Earth. Sunspots on the Sun proved that not everything beyond the Moon was perfect. And lastly, the phases of Venus contradicted the heliocentric model's positioning of Venus. The heliocentric model showed Venus to be close to the Earth. Its phases could not have been the approximately 18 months that Galileo observed. That would put Venus much further away from the Earth.

Figure 58: Galileo Galilei

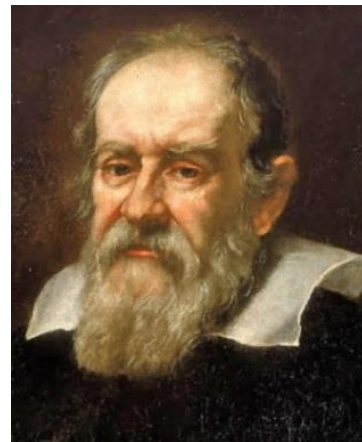
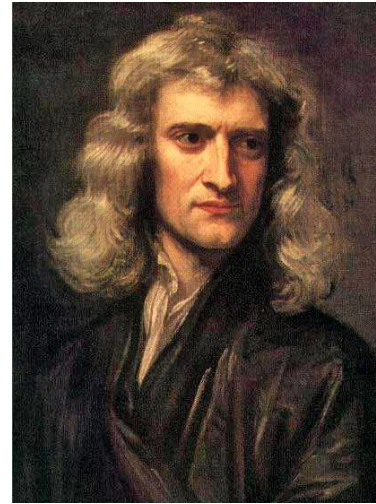


Photo by Adrian Pingstone

*Galileo is the first person on record to have turned a telescope to the night sky*

**Isaac Newton (1642-1726).** Newton was an English physicist. He was able to provide the scientific theory that explained why Kepler's model of the solar system worked: How gravity worked. Newton's laws of **motion** provided an answer until Einstein developed relativity.

Figure 60: Isaac Newton



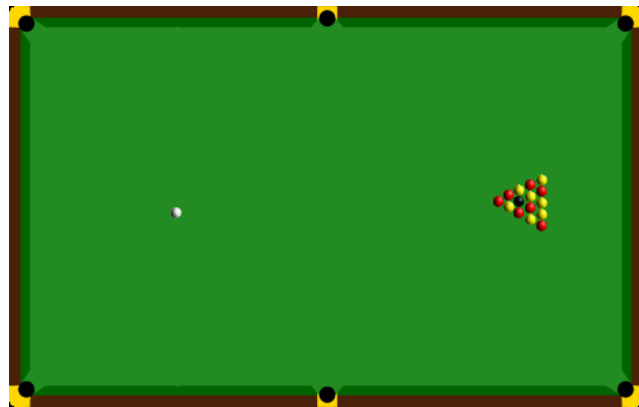
Newton's Laws are:

1. An object either remains at rest or continues to move at a constant velocity, unless acted upon by an external **force**.
2. A force is an object's mass multiplied by its acceleration:  $F = m * a$ .
3. For every action, there is an equal and opposite reaction.

**First Law – part 1:** With no outside influence the pool balls remain at rest.

*Newton developed the Laws of Motion that explained why Kepler's Laws worked*

Figure 61: Newton's First Law – Part 1



Drawing by Rcsprinter123

**First Law – part 2:** When the cue hits the cue ball, a force is applied to the cue ball and it moves.

**Third Law:** When the cue ball hits the red ball, if it is a perfect shot, the cue ball will stop, and the red ball which was not moving will move at the speed and in the direction in which the cue ball was moving.

Figure 62: Newton's First Law – Part 2

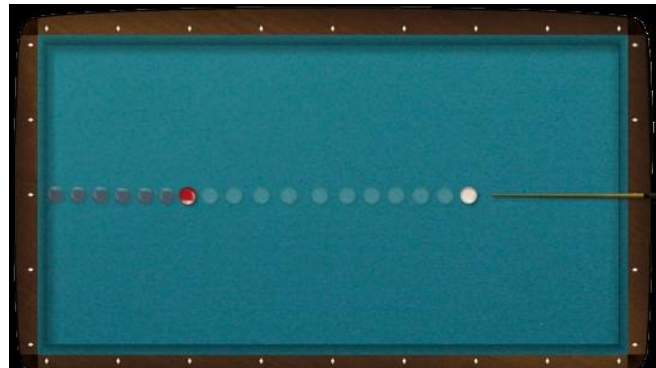


Photo by Escuela Virtual de Deportes

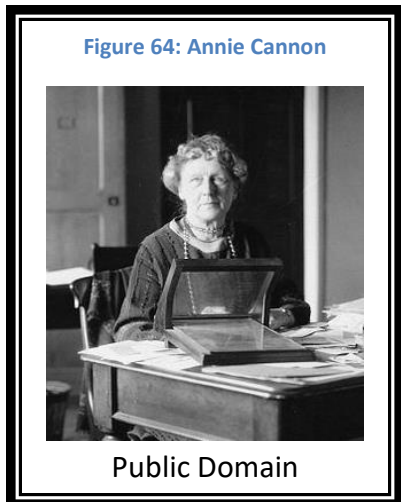
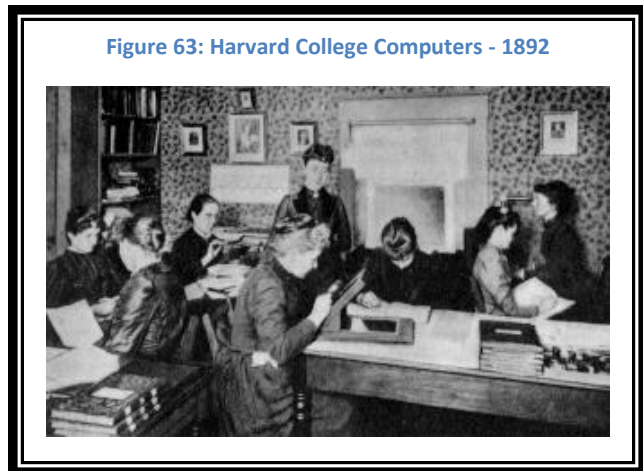
## Component 15 – Harvard University’s Computers

In the late 1800s and early 1900s the astronomical community was busy investigating the luminosities and spectra of stars. Harvard University had thousands of images that were taken that needed to be analyzed. They hired women to compute the data of the stars on those images.

These **women astronomers** analyzed hundreds of thousands of stars, taking millions of measurements. They were paid 25 cents per hour.

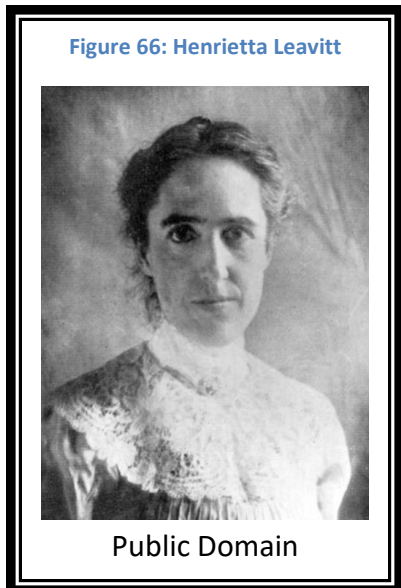
Their first major publication to come from their work was a catalog of the luminosity and spectra of tens of thousands of stars in 1890.

**Annie Cannon** was awarded the first honorary degree awarded to women at Oxford for her significant contributions to the classification of stars.



**Antonia Maury** undertook the most detailed study to **investigate star spectra** that had even been done, in 1897. Her data formed the basis for the **HR-Diagram**. She proposed the classification system that we still use today.

In 1908 **Henrietta Leavitt** discovered the Cepheid Variable Star period-luminosity relationship.



## Component 16 – Modern Astronomy

Since the time of Newton many men and women have contributed to our progress and knowledge in astronomy. There are too many to enumerate all of them. Instead, we will focus on the first American woman astronomer and a fairly recent and familiar astronomer.

### Women in Astronomy

Maria Mitchell (1818-1889). While many women have contributed to our knowledge in astronomy, **Maria Mitchell** is credited with being the first professional American woman astronomer. She discovered comet C/1847 T1 in 1847 using a telescope and received the King of Denmark's Cometary Medal.

### A Modern Theoretical Astrophysicist

**Albert Einstein (1879-1955)**. **Albert Einstein** had the ability to imagine things that most of us would never imagine to imagine. His thought experiments that he used to think through new and different explanations for the way the universe works are legendary.

Einstein received a Nobel Prize for his explanation of the **Photoelectric Effect** which paved the way for our understanding of how light behaves as photons (particles).

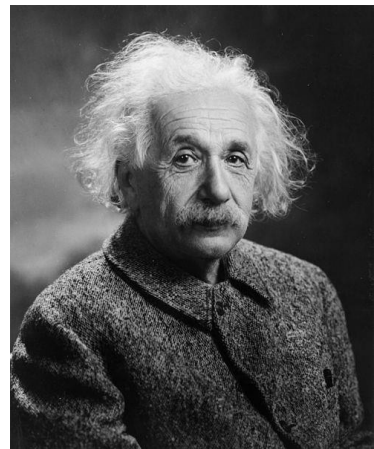
He also created the **Special Theory of Relativity** and **General Theory of Relativity** over 100 years ago. Relativity explains why Newton's Laws do not quite work with Mercury's orbit around the sun. They also make GPS possible.

Figure 67 Maria Mitchell



Painting by H. Dasell (1851)  
Public Domain

Figure 68: Albert Einstein



**\*\*\* SECTION III. ASTRONOMY – MEASUREMENT**

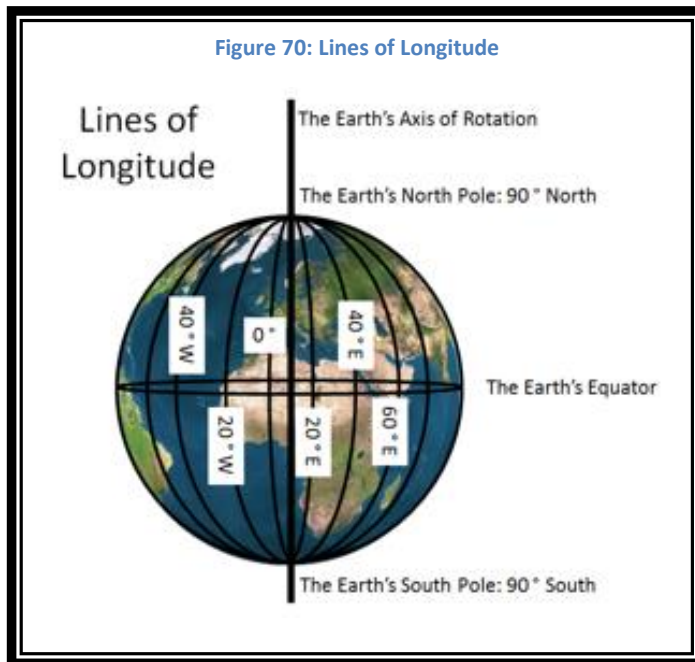
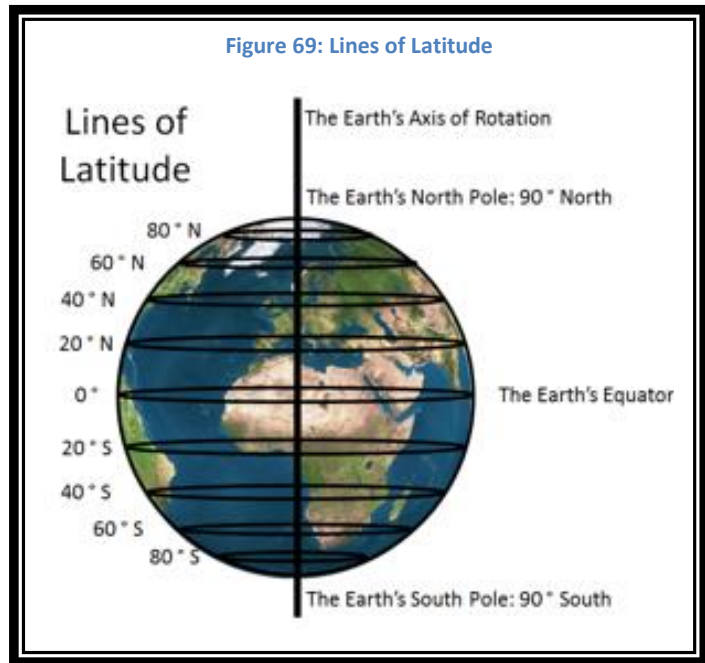


## Component 17 – Earth-Based Coordinates

### Earth Coordinates

Here on Earth, we use a spherical coordinate system of **Latitude** and **Longitude**.

Latitude (see Figure 69) defines how far above or below the equator an object is located. The drawing to the right shows how the lines of Latitude are arranged on the surface of the Earth. Latitude is measured in degrees, arc-minutes, and arc-seconds. 0 degrees is the equator and the poles are at 90 degrees. These angles are measured from the center of the Earth.

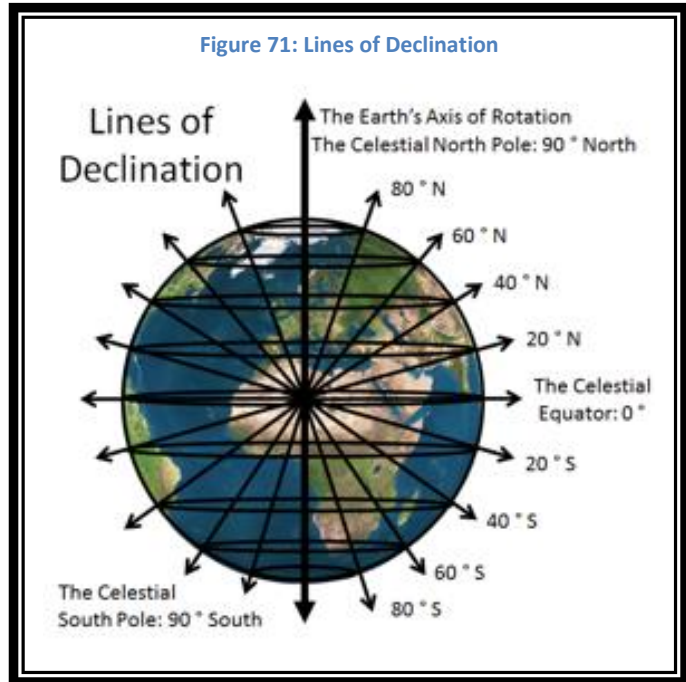


Longitude (see Figure 70) defines where an object is located as you move around the Earth. The drawing to the left shows how the lines of longitude are arranged on the surface of the Earth. Lines of longitude start at the North Pole, circle the Earth, and pass through the South Pole. Longitude is measured in degrees, arc-minutes, and arc-seconds. We need to define a starting point, or where the longitude equals zero. This line was defined as the longitude line that passes through the Royal Observatory in Greenwich, England. These angles are measured from the center of the Earth too.

**Right Ascension and Declination**

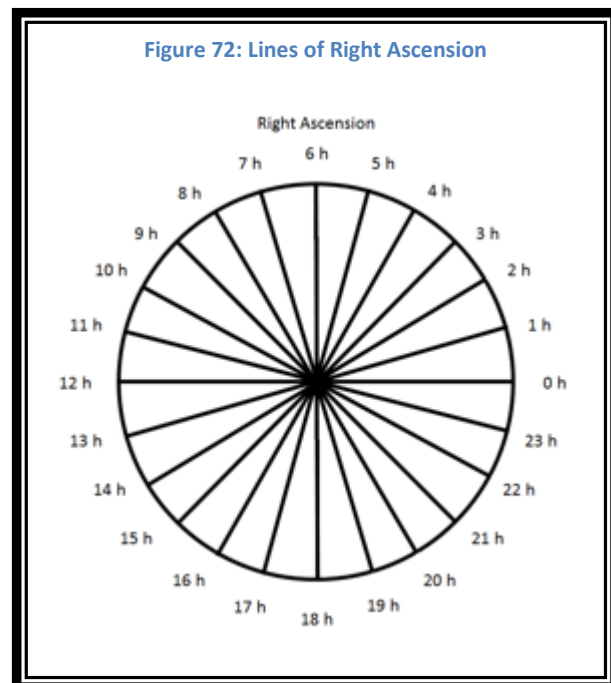
A coordinate system that astronomers use extends the Latitude and Longitude system that we use on Earth. It is measured in **Right Ascension** and **Declination**. Declination values (see Figure 71) are Latitude values extended into space.

Declination is measured from the **Celestial Equator** in degrees, arc-minutes, and arc-seconds. 0 degrees is on the Celestial Equator. +90 degrees, or 90° N, is the North Celestial Pole (**Celestial North**), and -90 degrees, or 90° S, is the South Celestial Pole.



The Earth's equator is extended out into space and is called the Celestial Equator. Right Ascension values are Longitude values extended out into space. But, we do not use degrees; we use **Hours** to measure the Right Ascension values. Each hour of Right Ascension is equal to 15 degrees. This means there are 24 hours of Right Ascension, just as there are 24 hours in a day. They are measured in hours, arc-minutes, and arc-seconds. The 0 hour line for Right Ascension passes through the Royal Observatory in Greenwich, England on the Vernal Equinox. Looking down from the Celestial North Pole at the Celestial Equator we would see a circle marked off in 24 hours of Right Ascension (0 hours through 23 hours).

This coordinate system, Right Ascension and Declination, is a good system for conveying information to other astronomers or people who are not standing right next to you. Stars and Deep Space Objects do not move in relation to Right Ascension and Declination, except over very long periods of time. This means that anyone can look up the



coordinates on a star chart and find the object with their telescope, and the coordinates are all the information they need from you to find it.

However, the Sun, the Moon, the planets, asteroids, comets and transient events (such as Meteors and man-made satellites) move independently of the background stars.

Their location in Declination and Right Ascension change rather quickly, over years, days, minutes, and sometimes even seconds. In these cases someone needs to know the Right Ascension, Declination, Date and Time, and sometimes your Latitude and Longitude as well.

### **Which to Use?**

The accuracy of the Altitude and Azimuth Coordinate System and the Right Ascension and Declination Coordinate System is the same. It depends on how accurately you measure the angles. Using your hands is not very accurate, but using a calibrated telescope mount can be very accurate.

The coordinate system to use depends on what you are observing and who you are communicating those coordinates to. For objects beyond the solar system when you are communicating to other observers who are not standing beside you, then Right Ascension and Declination are best. They provide a coordinate system that is independent of you, the observer. But these coordinates are tough to generate if you are describing the location of a new object.

But when you are describing the location of a new object, or an object that is within the Solar System, then these objects may

move relative to the background stars. This means that their Right Ascension and Declination may not be known, or it may be changing.

*Right Ascension and Declination are extensions of Earthly coordinates into space and are the Celestial Coordinates*

*The accuracy of either coordinate system is only a function of how accurately you measure the coordinates for the object. If you use your hands, they will be less accurate than if you used a well calibrated piece of equipment.*



## Astronomy for Mere Mortals – An Introductory Astronomy Text

When you are talking to another observer who is standing right next to you, the easiest system to use is Altitude and Azimuth. This lets the other observer see where you are looking at that time.

The difficulty with communicating an Altitude and Azimuth is that for a distant observer to recreate the situation you are seeing, you must also communicate the date, time, your latitude, and your longitude.

## Component 18 – The Nature of Light

We can relate to light. It is the thing that lets us see our surroundings. But there are many interesting characteristics of light.

### Light as Waves

**Diffraction.** To see light behave as a wave, you only need to shine it through a small hole in a wall. The image that the light makes on a screen beyond the wall is not a well-defined spot. Instead, there are diffraction rings. Figure 73 shows this effect from light shown through a pinhole. This is the same effect you see in a telescope when the objects are far out of focus.

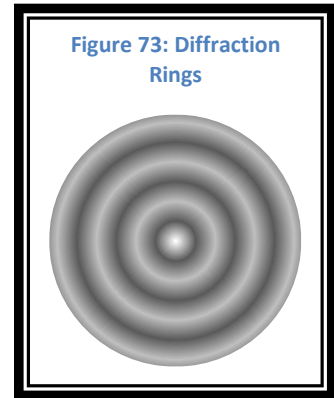
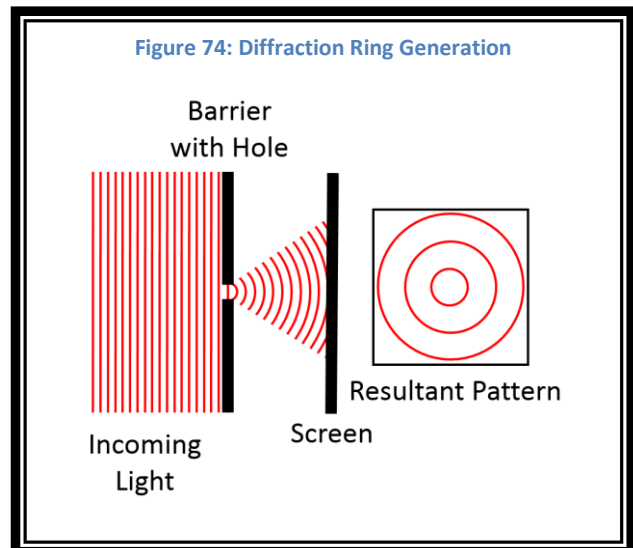
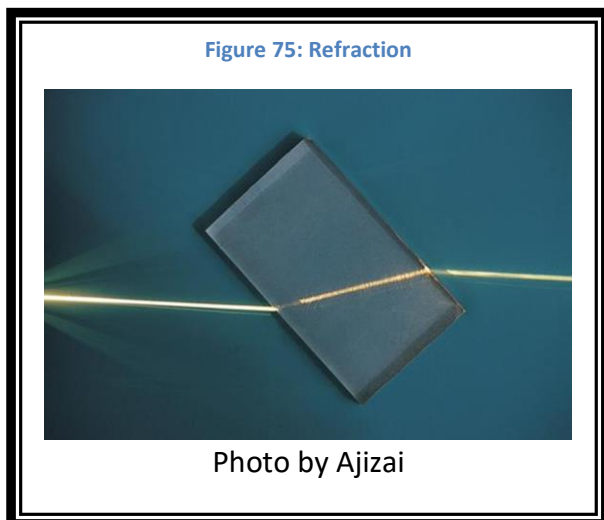


Figure 74 shows the apparatus to produce diffraction rings. The red lines represent the peaks of the light waves. The white between the red lines represents the valleys of the light waves.

**Refraction.** As light passes from one medium to another the path followed by those waves is bent. For example, passing from air into the glass of a lens will cause the light waves to bend (see Figure 75).



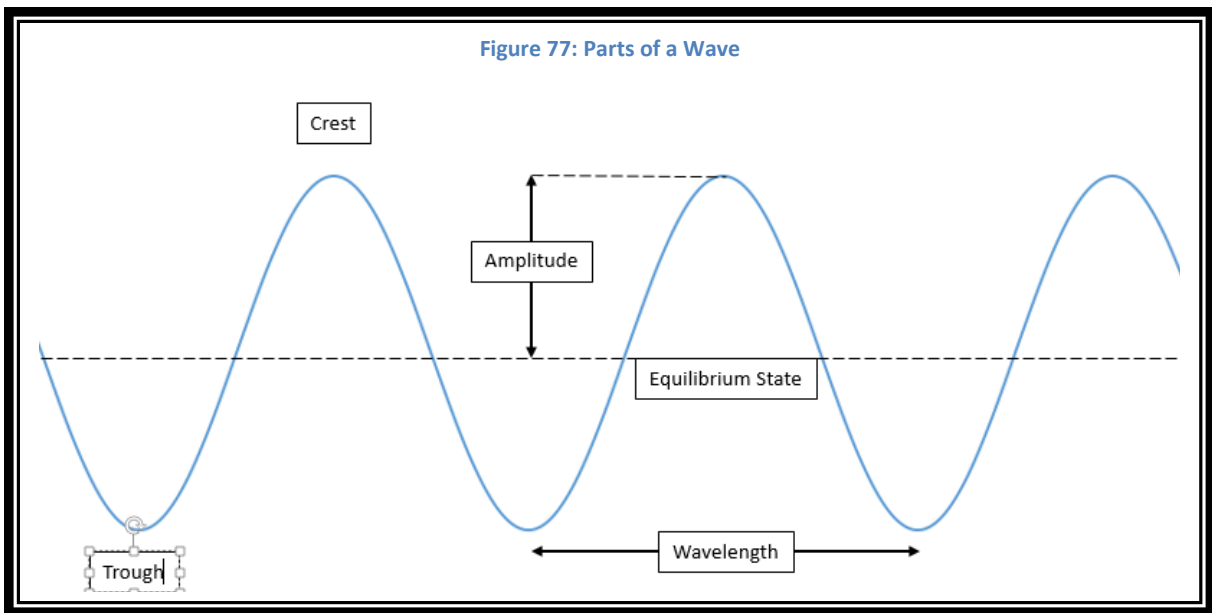
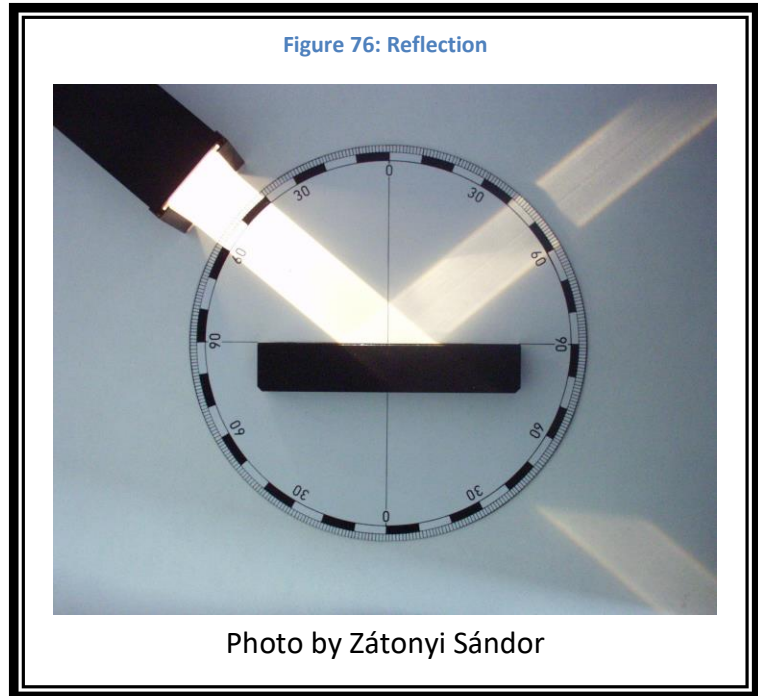
This is the principle involved in lenses used in refracting telescopes and binoculars. Different frequencies of light will bend different amounts. Red light will bend less than Blue light as it passes through a lens.

**Reflection.** Light that comes into contact with a reflective surface will bounce off the surface at an angle equal to the angle at which it arrived.

This is the principle involved in mirrors in reflecting telescopes. It is also the principle involved in the prisms in binoculars (see Figure 76).

Figure 77 shows a wave and labels the significant parts. These parts include:

- **Crest** – the top of each wave.
- **Trough** – the bottom of each wave.
- **Wavelength** ( $\lambda$ ) – the distance between any two Crests or Troughs. It is usually shown in nm (nanometers).
- **Amplitude** ( $a$ ) – the height of the wave above the equilibrium state
- **Equilibrium State** – the line where the amplitude is zero.



In addition to these features, there are additional characteristics that need to be understood.

- **Velocity (c)** – Light in the vacuum of space has a maximum speed. It is called the **Speed of Light**. The Speed of Light is 299,792 km/sec in a vacuum or 186,282 mi/sec. In this class we will use 300,000 km/sec or 186,000 mi/sec. The Speed of Light is shown by the symbol “**c**” in equations.
- **Frequency (f)** – when a light wave passes you, this is the number of crests that pass you per second. 1 crest per second is one **hertz**. The Frequency is equal to the speed of light divided by the wavelength.
- **Period (P)** – The Period of a light wave is the time it takes for the wave to pass you measuring from crest to crest. The Period equals one divided by the Frequency.

Equation 2: Frequency, Wavelength and Period

$$f = \frac{c}{\lambda} \quad \lambda = \frac{c}{f} \quad p = \frac{1}{f}$$

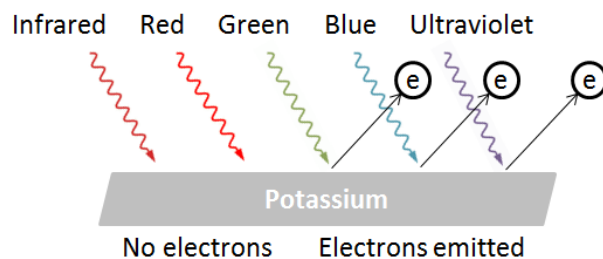
### Light as Particles (photons)

Light also behaves like small massless particles called **photons**. Einstein won his Nobel Prize in Physics for his studies of the Photoelectric Effect which demonstrated the particle nature of light.

Light of lower frequencies (infrared and red) is too low energy to eject electrons from the metal surface.

As the frequency increases, the energy increases. Once you have enough energy electrons can be ejected. Higher energy photons result in higher velocity electrons. More photons of the same frequency cause more electrons to be emitted.

Figure 78: The Photoelectric Effect



*Light can behave as waves and also at times as particles (photons)*

Equation 3: Photon Energy

$$e = h * f$$

h is Planck's Constant.  $h = 6.626176 * 10^{-34}$  joule-seconds.

### **Electromagnetic Radiation and the Vacuum of Space**

Sound waves in air and waves in water require atoms and molecules to move from place to place. The line from the movie Alien: “In space no one can hear you scream.” is correct. Since space is a vacuum, sound waves are not able to travel through space. Electromagnetic radiation is different. Light waves can travel through a vacuum. If this were not true, then space could not be a vacuum or we would see nothing beyond our atmosphere. The Earth would be cold and dark. But we do see stars and we do receive sunlight, and we now know that space is indeed a near vacuum.

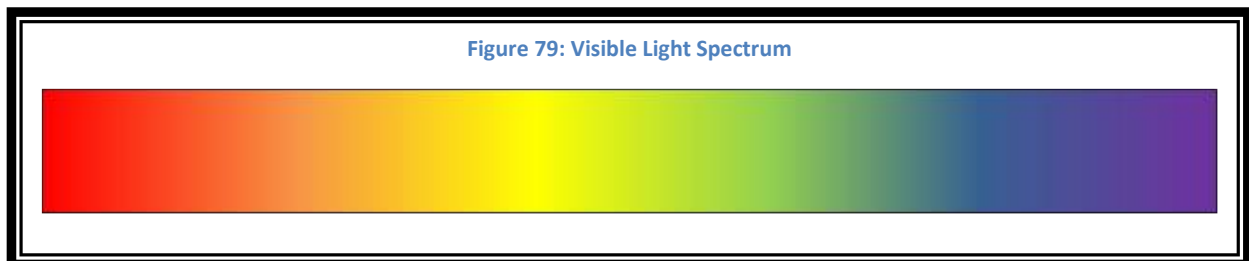
*Electromagnetic Radiation does not need a medium in which to travel. It can travel through the vacuum of space.*

## Component 19 – Electromagnetic Radiation

### Visible Light

**Colors.** We see light that ranges from Red to Violet. This is called the visible light spectrum. Although this is a gradual transition from Red to Orange and eventually to Violet, we break the colors that we see into groups: **Red, Orange, Yellow, Green, Blue, and Violet.** We remember the list by **ROYGBV.** (Note there is no “I”. Indigo is really a deep blue.)

We will discuss the characteristics of light in more detail under later principles, but for now the basics are useful to know.



*Visible Light is:  
Red, Orange, Yellow,  
Green, Blue, and Violet*

*Different frequencies tell us  
information about events at  
many different energy levels.*

**Frequency.** Frequency increases as you move from Red to Violet.

**Energy.** The energy of the photons increases as you move from Red to Violet.

**Wavelength.** Wavelength gets shorter as you move from Red to Violet.

### The Big Picture

But, the Visible Light part of the spectrum is only a tiny part of the overall Electromagnetic (**EM**) Spectrum. There are many larger pieces that we do not see.

**Radio Waves.** This is very low energy, and low frequency, radiation. We use Radio Waves in our daily lives for radio transmission, television transmissions, mobile phones, and GPS. This is how we communicate with satellites and spacecraft.

*Electromagnetic radiation types:  
Radio, Infrared Light, Visible  
Light, Ultraviolet Light, X-Ray,  
and Gamma Ray*

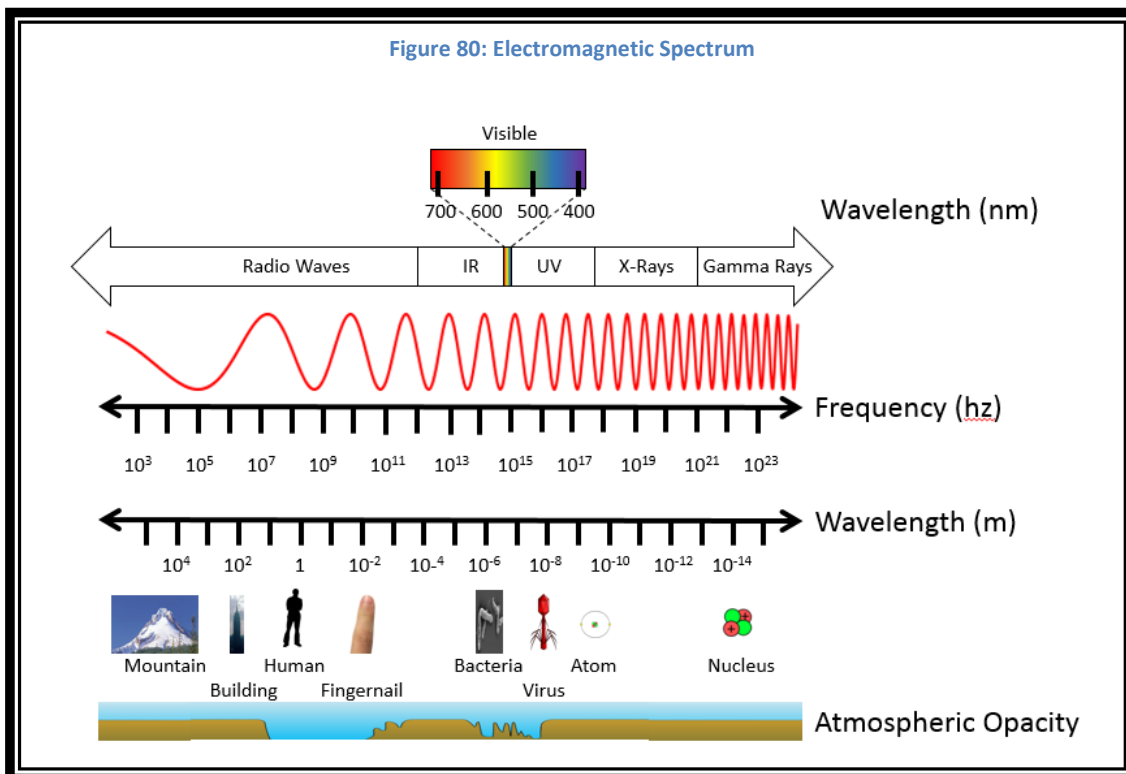
**Infrared.** Infrared Light is redder than red light, and is not visible to our eyes. When you go outside on a sunny day and you feel all warm and snugly, that warmth is infrared radiation coming from the Sun.

**Ultraviolet.** Ultraviolet Light is more violet than violet light. This too is not visible to our eyes. This is the type of radiation they use when you go to a tanning salon. It is responsible for sunburns, skin cancer, and cataracts.

**X-Rays.** Even higher energy and higher frequency are the X-Rays. We use this to see bones and teeth without the interference from muscles and skin.

**Gamma Rays.** And at the top of the scale are the Gamma Rays. These are very high energy with very high frequency. There are no typical day-to-day uses for this type of radiation.

**Electromagnetic Spectrum**



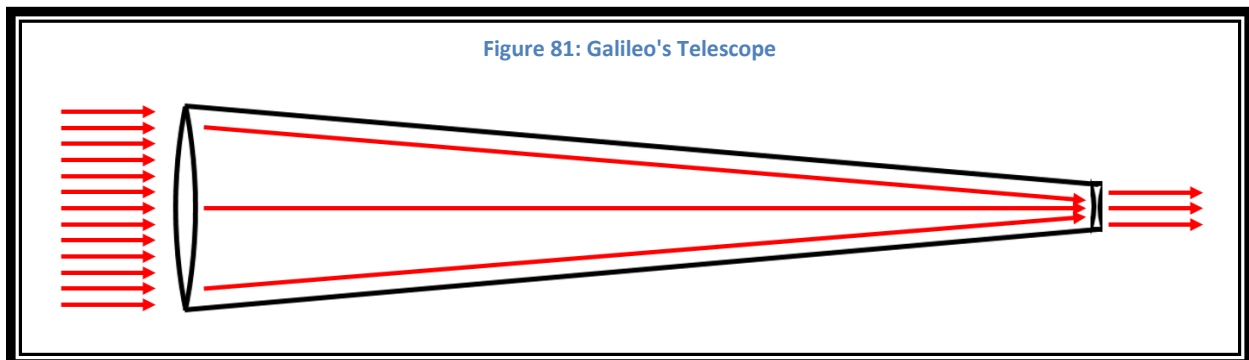
## Component 20 – Tools for Mere Mortals

Most celestial objects are too far away for us to travel to them to study them. Humans have only been to the Moon. Even our spacecraft are just now at the edge of the solar system, still light-years from the nearest stars. The only information we are able to get about those objects is brought to us on electromagnetic radiation.

Our eyes have pupils that dilate in the dark to about 5 mm in diameter. All of the light that we see from distant celestial objects must come in through those two tiny openings. To enable us to gather more information, we must gather more light. We build large telescopes, some with diameters of 30 meters, which collect light coming from those distant objects and focus it down to the 5 mm for our eyes' pupils, or to send it to a camera.

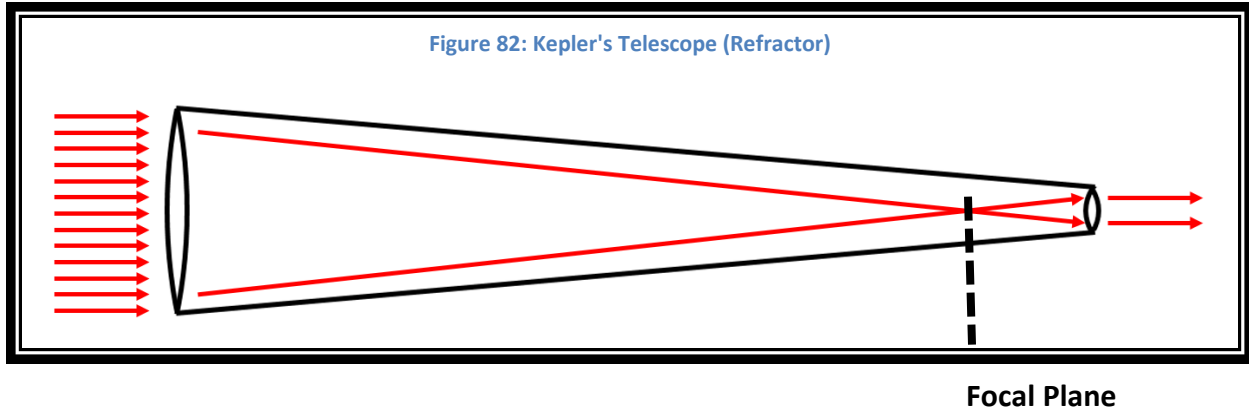
### Refracting Telescopes - Refractors

Galileo was familiar with optics, and that meant he could make lenses. The original telescopes used **lenses** to focus the light. These are Refracting Telescopes. They refract the light through the glass of the lenses. Galileo assembled his first telescope in 1609.



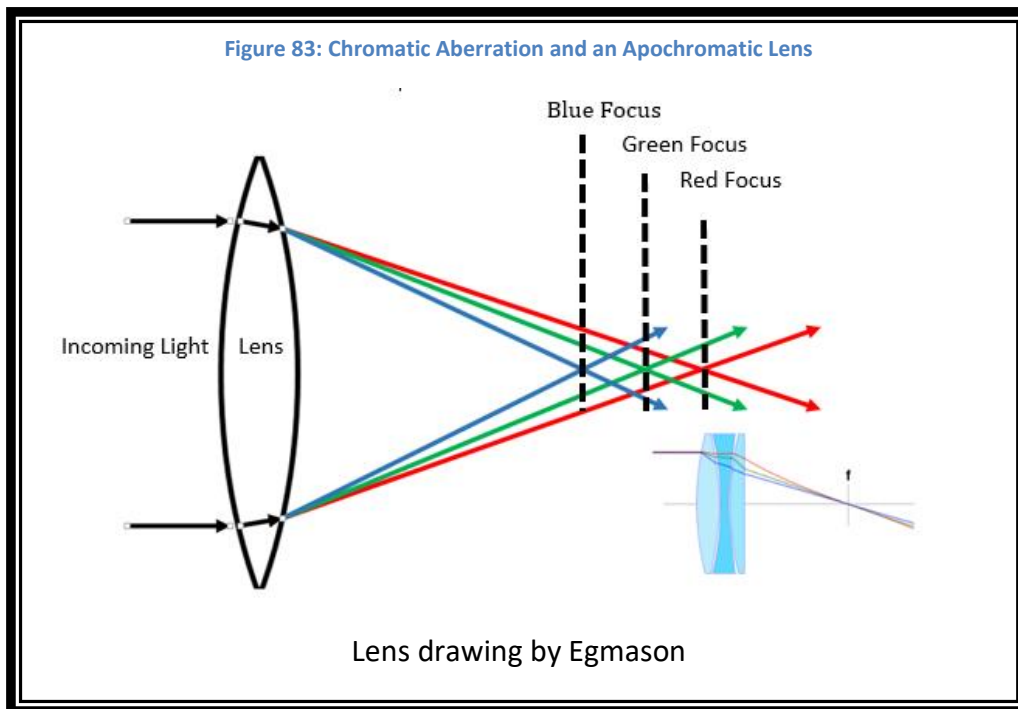
Galileo's telescope had different optics than what is in modern Refracting Telescopes. The light coming from a distant source arrives as parallel rays of light. The objective lens (on the left) bends the light. On the right end of the telescope, before the light reaches the focal point, a concave-convex eyepiece straightens the light before it goes to the eye of the observer. This resulted in rather low magnification and a small field of view.





Refracting telescopes have different optics than what was inside Galileo's Telescope. The light coming from a distant source arrives as parallel rays of light. The objective lens (on the left) bends the light. On the right end of the telescope, after the light reaches the focal point, a convex-convex eyepiece straightens the light before it goes to the eye of the observer. By using different eyepieces, those with different focal lengths, it is possible to get different magnifications. Johannes Kepler designed this type of telescope in 1611.

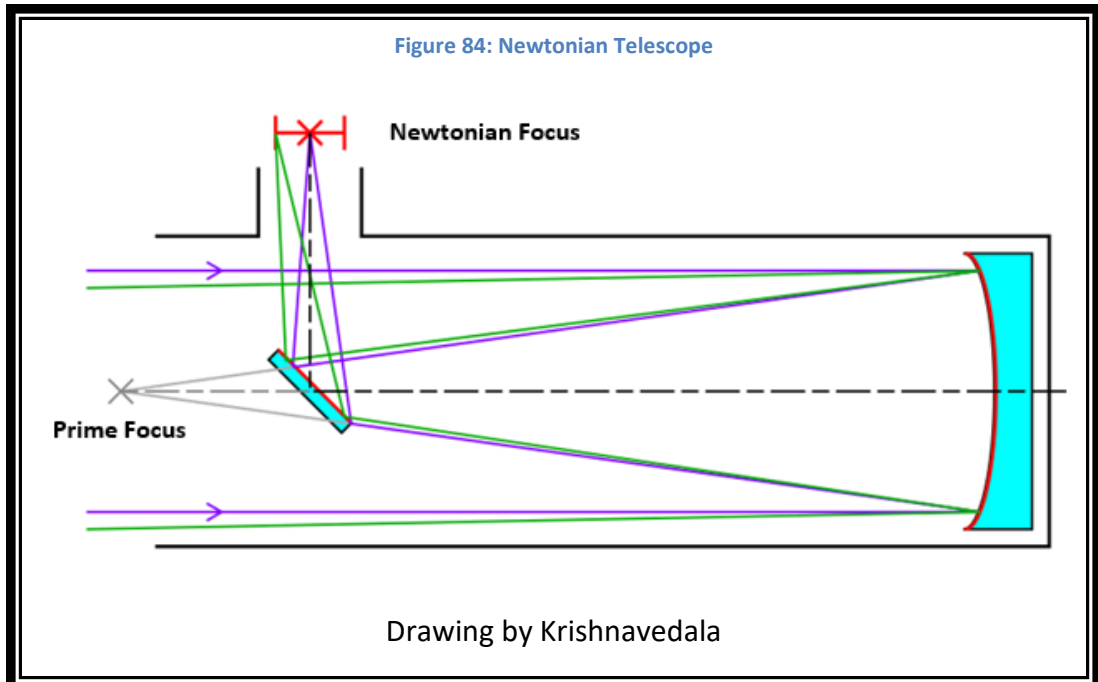
**Chromatic Aberration.** There is a problem with this simple design for a refracting telescope. It is called Chromatic Aberration. This is the result of the fact that different wavelengths of light focus at different distances from a lens. This means the red, blue, and green light will all focus at different focal planes (see Figure 83).



Telescopes with additional lenses to eliminate this are called Apochromatic Refractors.

### Reflecting Telescopes - Reflectors

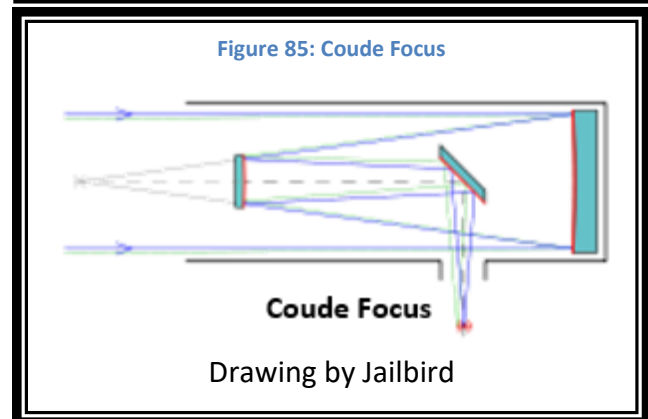
**Newtonian Telescope.** In 1668, Isaac Newton constructed the first known reflecting telescope. Newton realized that light could be focused using a parabolic **mirror**. Light that reaches the mirror will always focus at the focal point for the paraboloid. Newtonian Telescope use a secondary mirror to deflect the light before the focal point to an eyepiece in the side of the telescope.



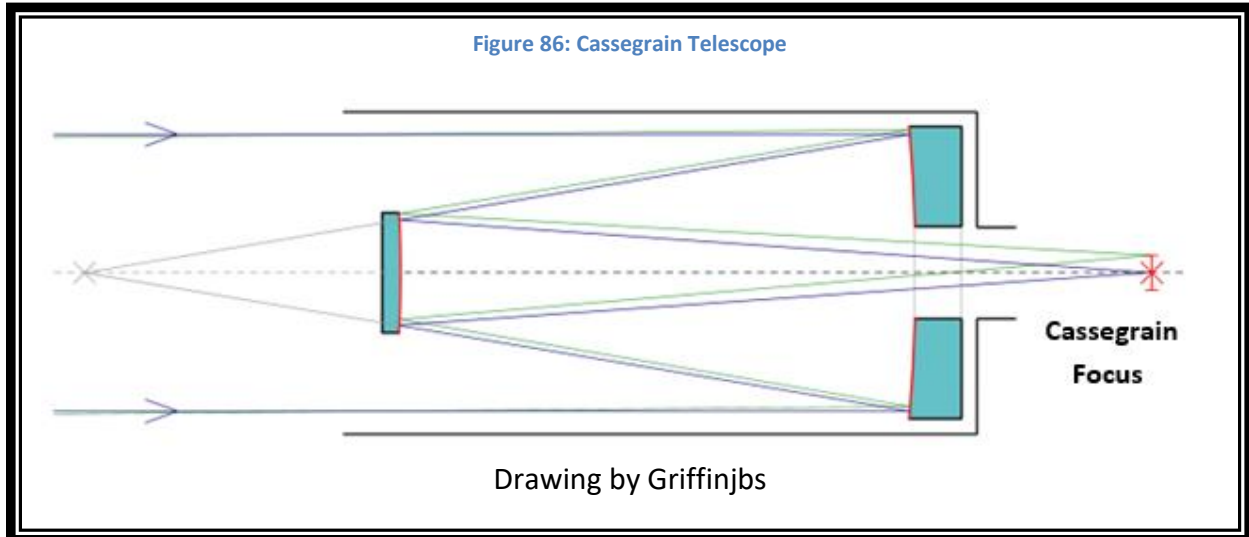
Note the **Newtonian** Focal Point and the **Primary** Focal Point in Figure 84.

**Coude Telescope.** A telescope that uses the **Coude** Focal Point is similar to a Newtonian Telescope, but the secondary mirror sends the light back towards the primary mirror. Before it reaches the primary mirror it is redirected by a tertiary mirror out of the telescope. In large research facilities this exit is often done through the Altitude axis of rotation. This is simpler if you want to use fiber optics to send the signal to a control room or additional instruments.

*Two categories of telescopes:  
Refracting and Reflecting*



**Cassegrain Telescopes.** Large aperture newtonian telescopes become very large. It is easy to imbalance them by connecting a heavy camera or CCD to the Newtonian Focus. Cassegrain Telescopes were developed to provide shorter telescope lengths and centerline installation for cameras and CCDs. These are often called Catadioptric Telescopes. This means that they incorporate mirrors and lenses in their design.



The light is folded inside the telescope, so the length of the telescope is roughly half of the length of a similar Newtonian Telescope. The light reflects off a Primary Mirror, reaches the secondary mirror and is then reflected back through a hole in the primary mirror to the **Cassegrain Focal Point**.

Two common types of Cassegrain Telescopes are the Schmidt-Cassegrain and the Maksutov Cassegrain. These variations have a thin glass lens that the light passes through as it enters the telescope.

**Focal Points.** So depending on the mirror configuration, there are four focal points used in astronomical telescopes:

- Prime Focus
- Newtonian Focus
- Coude Focus
- Cassegrain Focus

*The four focal points:*

- *Prime Focus*
- *Newtonian Focus*
- *Coude Focus*
- *Cassegrain Focus*

**Other Designs.** There are many other designs of telescopes that have been developed to try to enhance the quality of the image. The ones presented here are the types that are most common, and that we will encounter in this class.

**Altitude/Azimuth (Alt/Az) Mount.** An **Alt/Az** mount is a simple mounting for a telescope. It lets the telescope move up and down (altitude) and the telescope can rotate (azimuth). This is ideal for a manually operated telescope since the movements align with the orientation of the observer. If you are using this mount and taking images with your telescope, it is necessary to make guiding adjustments in both altitude and azimuth. This is more complex and not ideal for taking images. The mount is simple, easy to use and much lighter than an equatorial mount.

**Equatorial Mount.** An **equatorial** mount is designed to follow objects in the night sky as they move across the sky due to the Earth's rotation. The mount's movements are in Declination (angle above and below the Celestial Equator) and Right Ascension (angle along the Celestial Equator). Once you have found an object, it is only necessary to adjust the Right Ascension to guide the telescope. Declination will not change. This means that Equatorial Mounts (see Figure 88) are better suited to taking images. The mount tilts the telescope at an angle equal to the observer's Latitude. It is oriented towards north and it is ready to observe or to take images. The mount is heavier than the Alt/Az Mount due to the counter weights.

Figure 87: Altitude/Azimuth Mount



Photo by Bashir001

Figure 88: Equatorial Mount



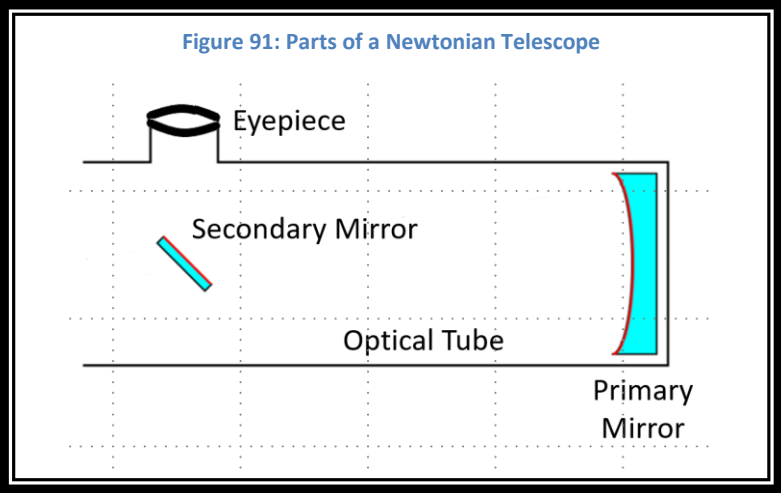
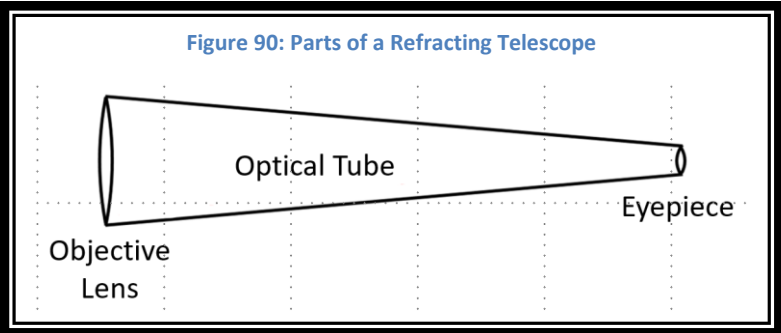
Photo by Gn842

*Two types of mounts:  
Alt/Az and Equatorial*

**Dobsonian Telescope.** A Dobsonian Telescope is a telescope designed to sit on a flat surface. It can be pointed up and down (altitude) and can be rotated (azimuth). This design was invented by John Dobson in the 1950s (see Figure 89). These telescopes are a simple design with a simple mount, and are a very cost effective way to make a telescope. These telescopes are responsible for bringing large aperture telescopes into the hands of the the general population. Dobsonian Telescopes are always Alt/Az mounted.

**Parts of a Typical Telescope**

A refracting telescope has far fewer parts than a reflecting telescope.



## Component 21 – Recording What We See

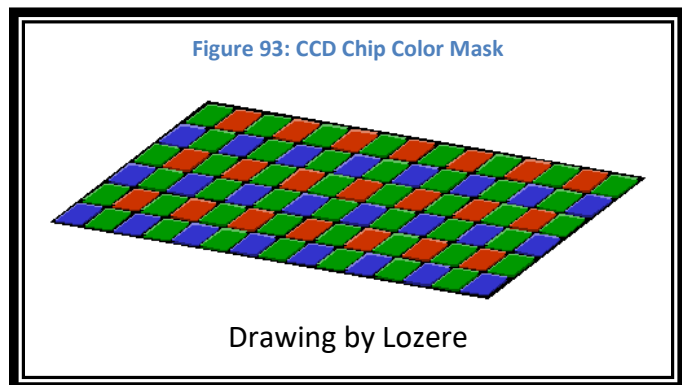
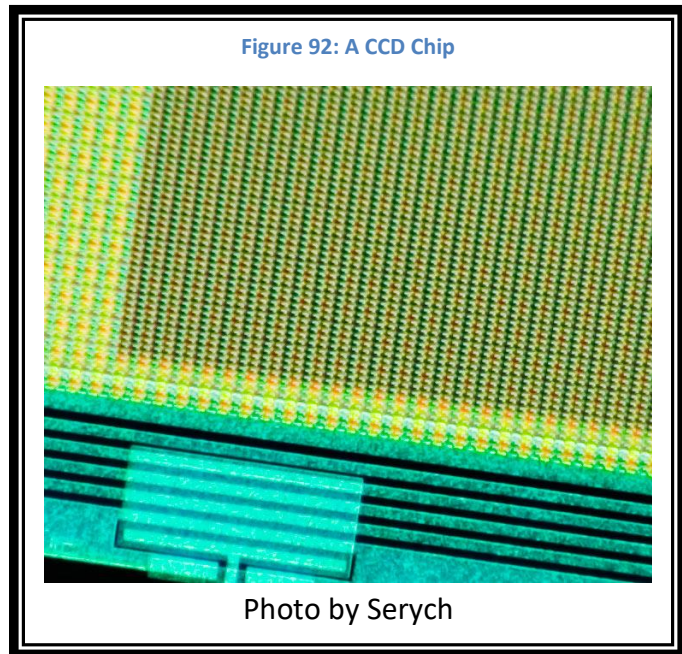
When we view objects with our eyes, we may marvel at the detail, we may be in awe of their beauty, but they are fleeting glimpses and are soon gone. To continue studying the objects, and to be able to review them at our leisure, we often want some way to record what we see. In the early days, this was done on glass plates or with film cameras. Today there are better tools to capture those images.

### The CCD

The **CCD** chip (Charge-Coupled Device) is an electronics chip that senses photons and converts them into electricity. The chip may contain thousands or millions of cells, called pixels. As the influx of photons increases, the charge increases proportionately. As the number of pixels increases, the resolution of the image also increases.

CCD chips in astronomy cameras often are black and white, not color. This means that every pixel is used to capture a piece of the image. Color cameras use neighboring pixels for different colors, so the resolution is reduced. To get a final color image, pictures are taken through color filters. Each color filter sees only that specific color of light. When the pictures are combined (stacked) on a computer, the result is a color image. The most common set of color filters are red, green, and blue.

**CCD Filters.** Standard filters used to generate color images are red, green, and blue. Images are taken with no filter and also with each of the color filters. These images are then combined (stacked) using computer software to create a full-color image.



### **Using the CCD Data**

**Spectroscopy.** If the light from the celestial object is sent through a spectroscope, it will be broken down into its individual components. This can then be recorded by the CCD and the spectrum can be analyzed on the computer.

**Photometry.** Photometry is the study of brightness of the light from an object. CCD detectors, unlike film cameras record light coming in linearly. This means that if you collect an amount of light from a star ( $X$ ) over a time ( $T$ ), then if you have an object twice as bright it will collect two times the amount of light ( $2X$ ) in the same amount of time. Or, the same object recorded for twice as long will also capture twice the amount of light ( $2X$ ). This analysis is most often done using a computer to analyze the pixels in the image.

**Astrometry.** Another activity that uses CCD images is Astrometry. With the accuracy of CCD detectors it is possible to use the computer to calculate the precise location of an object relative to known objects in the image. This is valuable for tracking the movement of asteroids and comets.

## Component 22 – Seeing More Detail

If you are observing with a telescope sitting on the ground on Earth, there is only so much you can do with the telescope itself to improve the images it records. You can provide better optics, larger apertures, and higher resolution CCD chips, but that is the extent of that which you control. You still have the atmosphere between your telescope and the objects. We will explore techniques that have been pursued to overcome challenges caused by the atmosphere.

### Location, Location, Location

For a long time astronomers have built their telescopes in locations where the atmosphere produces less of a challenge. Criteria for placement include:

- **High:** High altitudes – to get above much of the atmosphere.
- **Dry:** Desert climates – to reduce the impact of humidity.
- **Remote:** to reduce the impact of light pollution from civilization.

This is why many of the world's largest and most productive observatories are located on mountain tops. Examples would include the mountains of Chile, the mountains of Hawaii, and even the mountains of West Texas.

### Active Optics

But location is not all you can do. You can build the mirrors of your telescope so that they can be adjusted while in use to compensate for changes in the atmosphere. This is done by employing computers to

analyze the images and make quick corrections for disturbances. This can compensate for changes in the mirror due to temperature and barometric pressure changes, changes in the air

*To eliminate problems from the atmosphere and light pollution, we place telescopes:*

- *At high altitudes to get above the atmosphere*
- *In the deserts to have low humidity*
- *Remote from civilization*

Figure 94: Active Optics Actuators, the Microlensing Observations in the Astrophysics (MOA) telescope

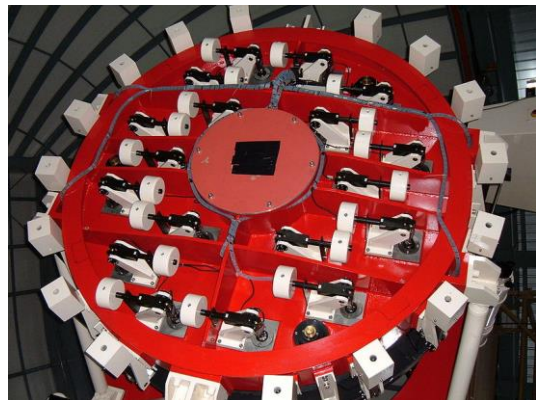


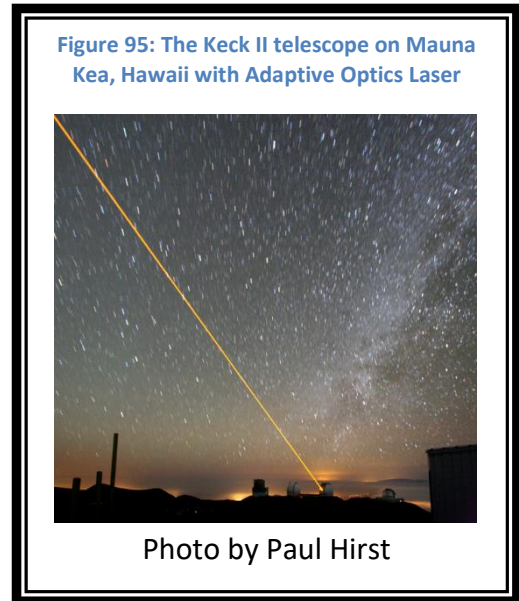
Photo by Evil Monkey



temperature inside the dome, and even turbulence in the atmosphere. Changes in dome designs, mirror temperature control, and mirror shape control all contribute to better imaging from the telescope. Resolution can be improved to tenths of an arc-second, far better than can be obtained without active optics.

### **Adaptive Optics**

In an effort to further improve the capabilities of a telescope, and to compensate for additional disturbances in the atmosphere, astronomers employ Adaptive Optics. Adaptive Optics provides a means to adjust the parts of the mirror in real-time. Using a laser, an artificial star is created high in the atmosphere. This artificial star is above most of the atmosphere and when changes are noted in the appearance of this star, the mirrors can be adjusted to compensate. These changes can be done thousands of times per second. This provides sharper images of real stars and other celestial objects. The lower the frequency of the light being observed, the easier it is to apply Adaptive Optics. This is due to smaller affects on Infrared Light in the atmosphere than Visible Light. Also, the lower the frequency, the greater the tolerances for making adjustments.



## Component 23 – Space from Space

The Earth's atmosphere, although very valuable to life on Earth, is a hindrance to most astronomy. Some **frequencies** are able to penetrate the atmosphere to telescopes on the ground, but some cannot. Visible Light and Radio Waves are not hindered by the atmosphere itself, but there are air currents in the **atmosphere**, **light pollution**, dust, clouds, birds, and humidity that reduce the quality of images taken in the visible part of the spectrum. Fortunately, Radio Waves are not impacted.

To eliminate these problems, all you need to do is eliminate the atmosphere. The solution is to place telescopes in space. Initially, small telescopes and observatories at many different frequencies were placed on satellites. These were followed by larger and higher resolution observatories. These large observatories are often referred to as the Great Space Observatories:

- **Spitzer** Telescope (Infrared Light)
- **Hubble** Telescope (Visible Light)
- **Chandra** X-Ray Telescope
- **Compton** Gamma Ray Observatory
- **James Webb** Telescope (Infrared Light)

*We put telescopes in space to overcome problems with looking through the atmosphere*

In 1946 Lyman Spitzer proposed placing telescopes in space. The result of his lobbying was the launch of the Hubble Space Telescope in 1990. But there were many observatories before, and since, Hubble.

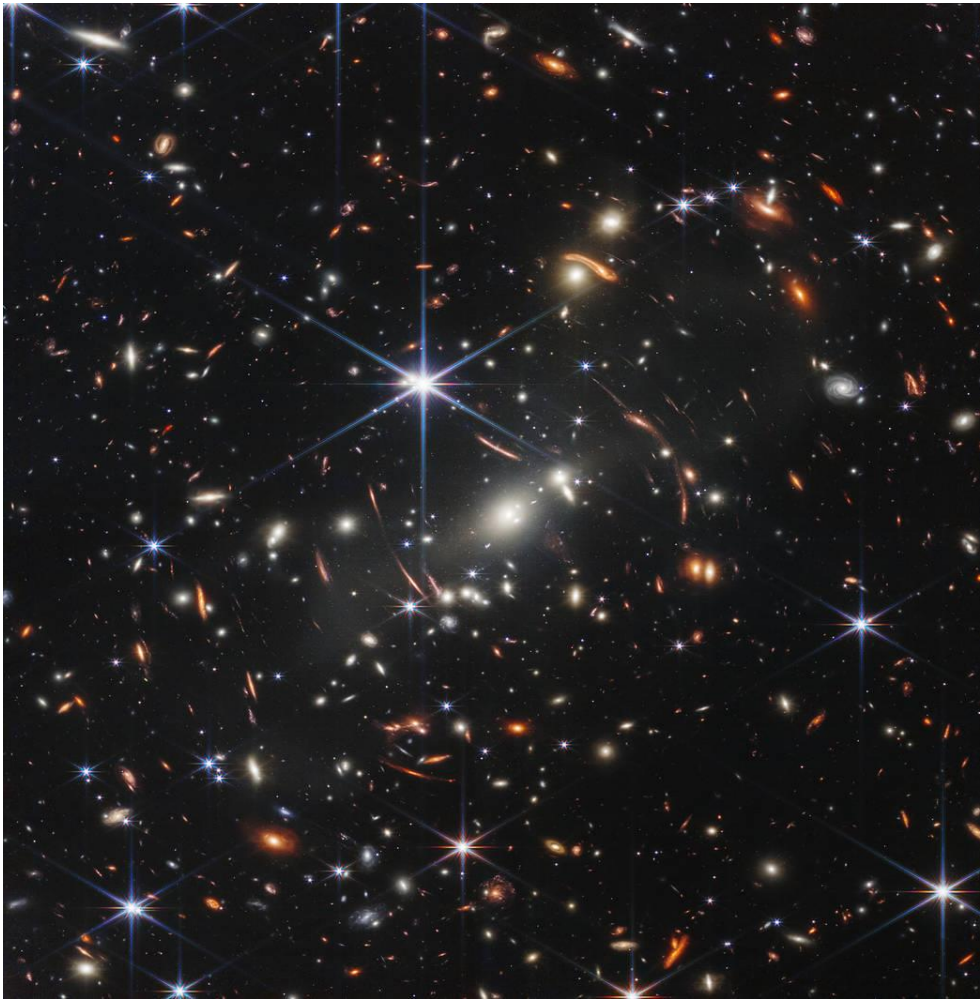
### Visible Light Observatories

In 1989, the European Space Agency launched the Hipparcos Observatory. The purpose of this observatory was to accurately measure the locations of stars. It was followed by the Hubble Telescope in 1990. Hubble and James Webb have yielded an incredible number of images of objects and deep space fields. The Hubble Ultra-Deep Field image is roughly the size of a full moon. The early galaxies visible in the image are 13.2 billion light-years away. This means they are the universe as seen roughly 450 million years after the Big Bang. Almost every object in the Hubble Ultra Deep Field image and the James Webb Deep Field image is a galaxy or proto-galaxy.

Figure 96: Hubble Telescope



Figure 97: James Webb Deep Field Image



## Component 24 – Seeing Beyond the Visible

There are many forms of electromagnetic radiation that we are not able to see. Some we can sense (Infrared Light makes us feel warm, Ultraviolet Light causes sunburns and skin cancer), some we use (Radio Waves for communications, X-Rays to see broken bones), but all of them are travelling through the universe with information to share. To “see” these other forms of radiation, we need to use special instruments that can detect it and that can provide the information they contain in a way that we can understand it.

### Radio Observatories

We construct very large telescopes to detect Radio Waves. The largest single dish radio telescope is the **FAST** (Five-hundred-meter Aperture Spherical Telescope) located in China. It was built using mountains as the base and began operation in September 2016. The sensors that detect the radio waves are located at the prime focus and are suspended from cables. Since the telescope can't point at specific objects, the sensors can be moved along the cables to point in slightly different directions.

*The largest radio telescope in the world, FAST, is located in China*

The largest steerable radio telescope in the world is the National Radio Astronomy Observatory in **Green Bank**, WV. It has a dish that is over 300 feet across and stands at a total height of over 450 feet. The receiver is located at the prime focus, but the dish is designed so the prime focus is off to the side, or “off-axis” so there is no obstruction to the incoming light.

Figure 98: FAST Observatory



Copyright Jeff Dai,  
Used with permission.

Figure 99: Off-Axis Optics

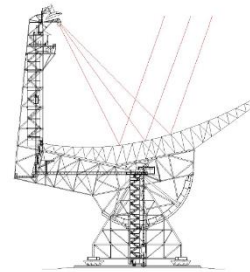


Photo by NOAA

Figure 100: Green Bank Telescope



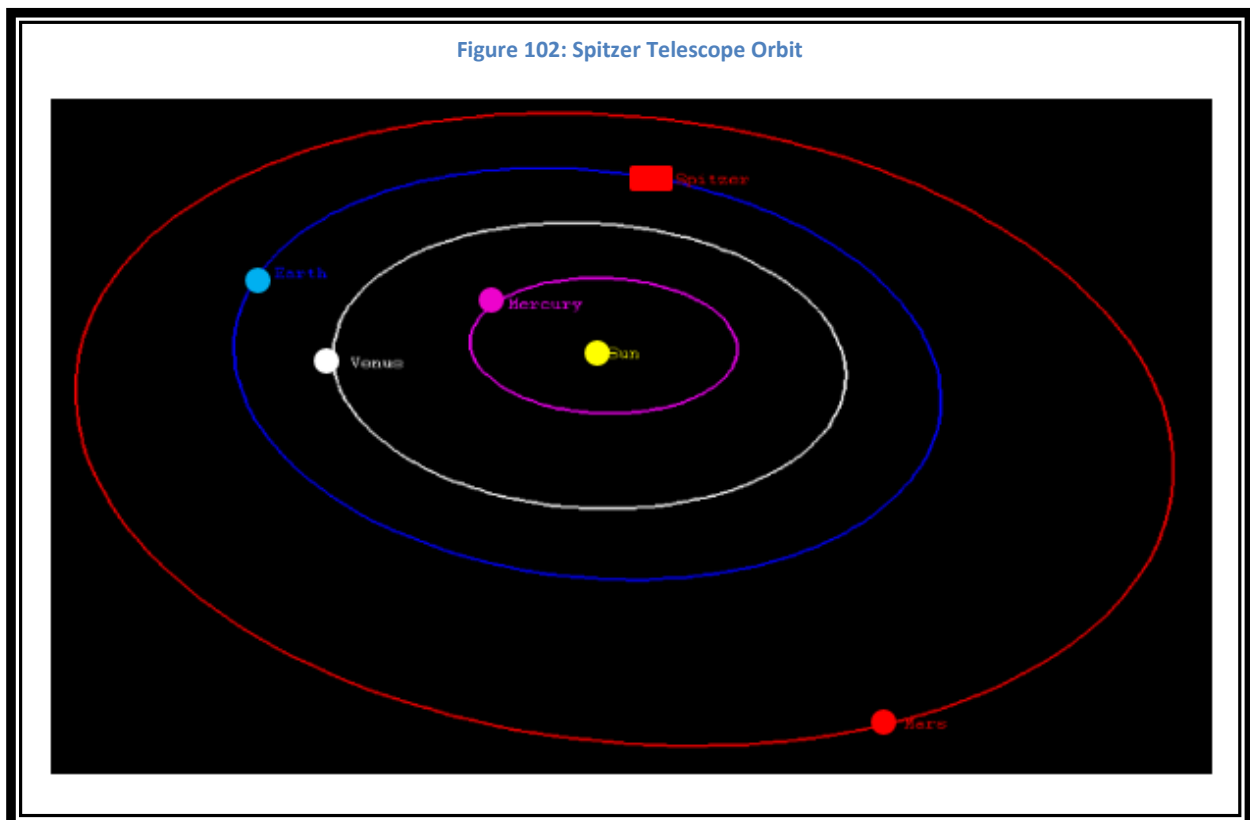
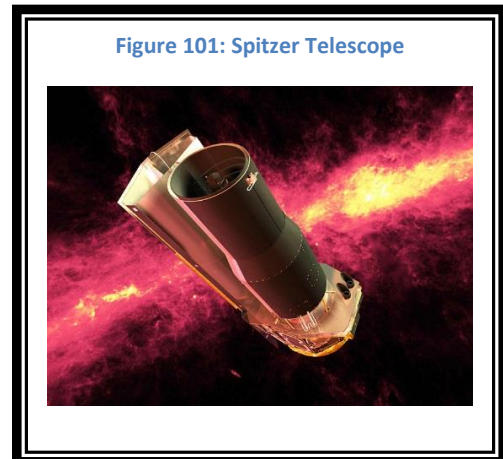
Photo by NOAA

## Infrared Observatories

Infrared and Ultraviolet telescopes are very similar in design to Visible Light Telescopes. The detectors are designed to detect light at the different wavelengths. Since these frequencies of light do not penetrate through the atmosphere very well, these are not productive as ground-based telescopes.

The first large Infrared Telescope is the Spitzer Space Telescope. This telescope was launched in 2003 and was placed in Earth's orbit following the Earth to enable it to be far from the infrared radiation of the Earth.

The position of the Spitzer Telescope is the red rectangle in the blue orbit in Figure 102 . Earth is the blue dot. The white dot is Venus, and the red dot is Mars.



The most recent Infrared telescope is the James Webb Space Telescope. It was launched on December 25, 2021. This telescope observes near and mid-infrared light. The mirror is gold to better reflect infrared light.

To increase its sensitivity to infrared light, the telescope is located in an orbit around the Earth-Moon L2 Lagrange Point.

Figure 103: James Webb Telescope

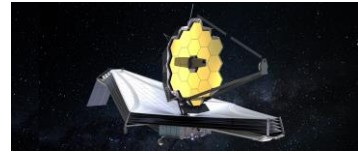
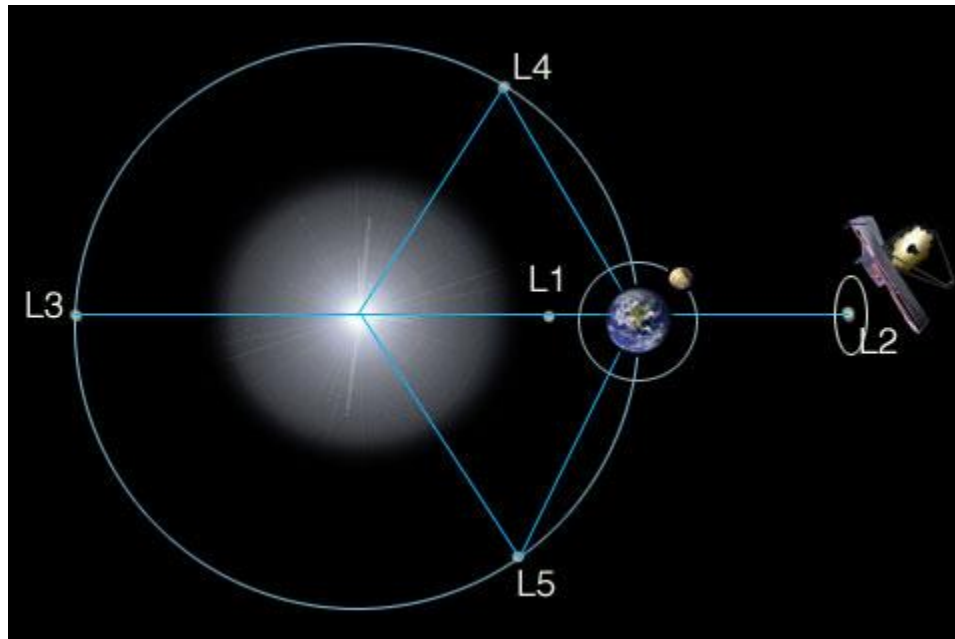


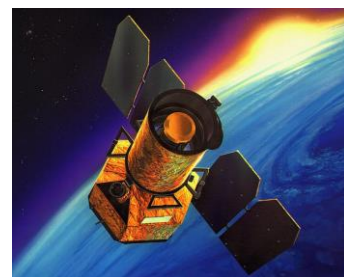
Figure 104: James Webb Telescope Orbit



### Ultraviolet Observatories

In 1968 the OAO-2 observatory was launched to study the stars in ultraviolet. There was no Great Space Observatory to study ultraviolet light from space, but there is an instrument on the Hubble Telescope that images in the ultraviolet. The most notable being the Galaxy Evolution Explorer (GALEX) launched in 2003.

Figure 105: GALEX Telescope



## X-Ray Observatories

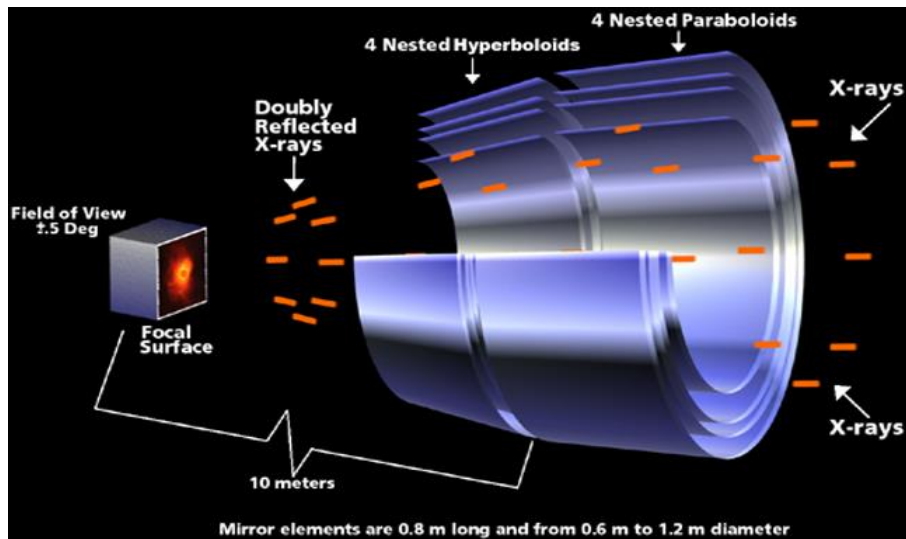
The first **X-Ray** Observatory was launched in 1970 called the Uhuru. The Chandra X-Ray Telescope, one of the Great Space Observatories, was launched in 1999. Unlike telescopes that observe in other parts of the electromagnetic spectrum, X-Ray Telescopes must use nested concentric rings to focus X-Ray photons because they are so powerful they would fly through parabolic dishes.

Figure 104: Chandra Telescope



*X-Ray Telescopes use nested rings to focus the powerful X-Ray photons.*

Figure 107: Chandra Telescope Structure



### Gamma Ray Observatories

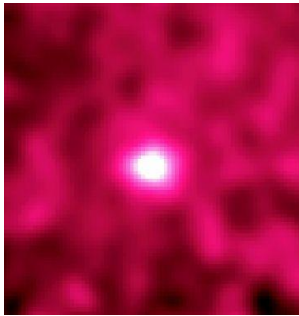
**Gamma Rays** are very powerful photons. They are so powerful that they cannot be focused at all. So there are no Gamma Ray Telescopes. In 1972 the Second Small Astronomy Satellite (SAS-2) was launched to study Gamma Rays. In 1991 the Compton Gamma Ray Observatory was launched as one of the Great Space Observatories.

*Gamma Rays are so powerful  
that they can't be focused!*

Figure 08: Compton Gamma Ray Observatory



Figure 109: Moon Image  
(Gamma Rays)

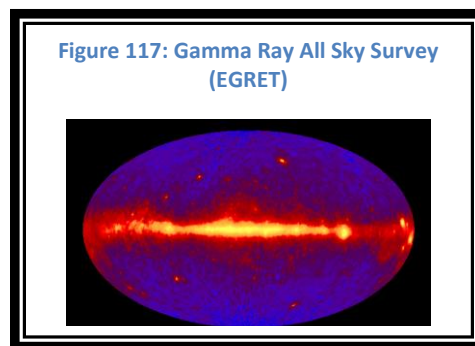
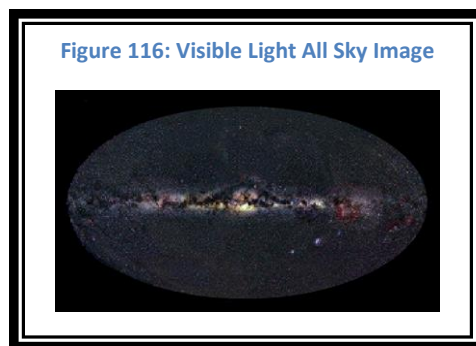
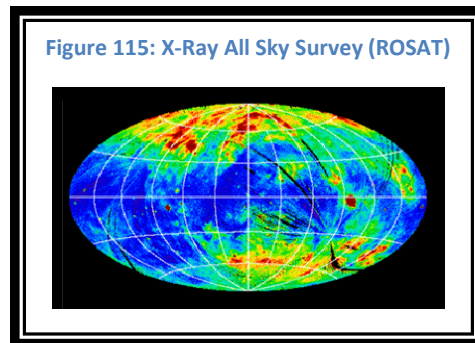
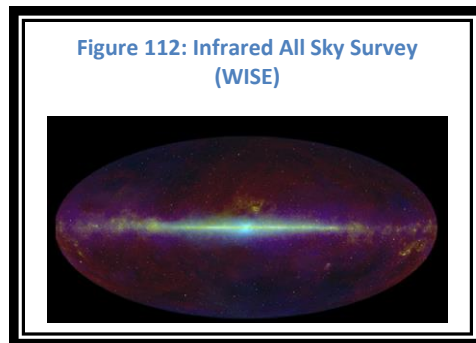
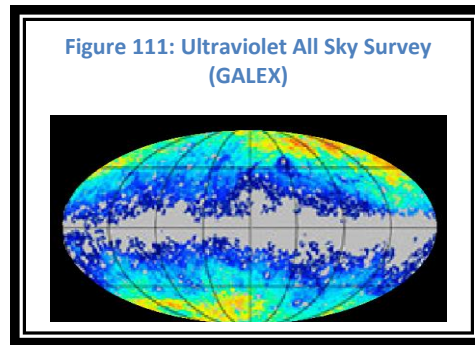
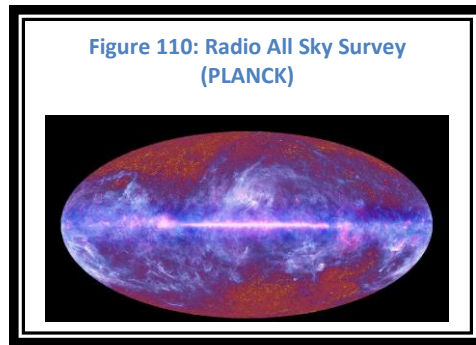


The mission for the Compton Gamma Ray Observatory ended in 2000. It completed an all-sky survey in Gamma Ray frequencies.



## Component 25 – Seeing it All

Different telescopes have taken surveys of the entire sky. At different frequencies they tell us information about different sources of photons. Without information at all these frequencies, we are still in the dark.



*Information at different frequencies: combined, we have a more complete picture of the universe*

## Component 26 – Interferometry

Another technique that will improve the resolution in an image is called **Interferometry**. This is the combining of signals from multiple telescopes that are taken at the exact same time. There is a difference in the signal that each telescope receives because of the distance between the telescopes. Sometimes the signals are synchronized and sometimes they are not. When these signals are combined the result is constructive and destructive interference that emphasizes the signal and enhances the resolution of the objects in the image.

The improved resolution is equivalent to a telescope with a mirror or dish that is the diameter of the grouping of telescopes. This means that radio telescopes can attain resolutions similar to those that are available in visible light telescopes.

*Interferometry uses multiple telescopes to improve resolution*

Timing however is critical. The shorter the wavelength, the more difficult it is to synchronize the telescopes. **Radio Wave** Interferometry is the easiest to do. It can also be done with **Infrared Light** and **Visible Light**. Shorter frequencies require coordination and timing that is not available today.

### VLA – Very Large Array

One Radio frequency interferometer is called the **VLA**, the Very Large Array. It is a group of 27 radio telescopes in a “Y” pattern. Each telescope is 82 feet in diameter and the dishes can be moved to positions 22 miles across.

### VLBA – Very Long Baseline Array

Another even larger configuration of radio telescopes is called the Very Long Baseline Array (**VLBA**). 10 Telescopes are located across the Earth and can be configured to a total baseline size of 4970 miles.

Figure 118: VLA in New Mexico



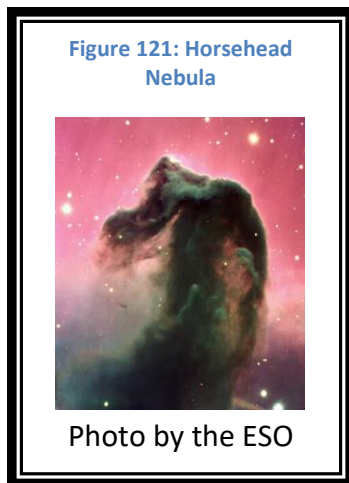
Photo by CGP Grey

Figure 119: VLBA World Map



### VLT – Very Large Telescope

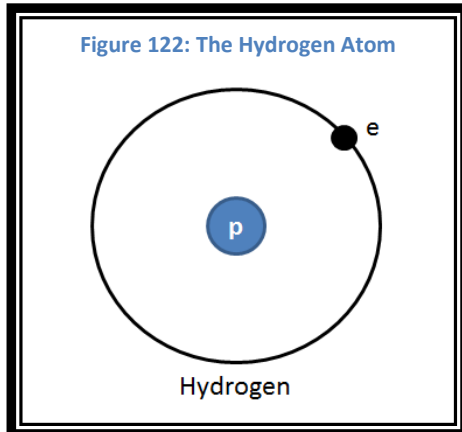
The Very Large Telescope (VLT) array is a group of four Visible Light Telescopes located in the mountains of Chile. Each telescope is 8.2 meters in diameter. By using all four telescopes and interferometry, the astronomers get a resolution 25 times better than when they use a single telescope. They are able to see objects at magnitude 30.



*Interferometry can be done with  
Radio, Infrared and Visible Light*

## Component 27 – Photons from Electron Energy States

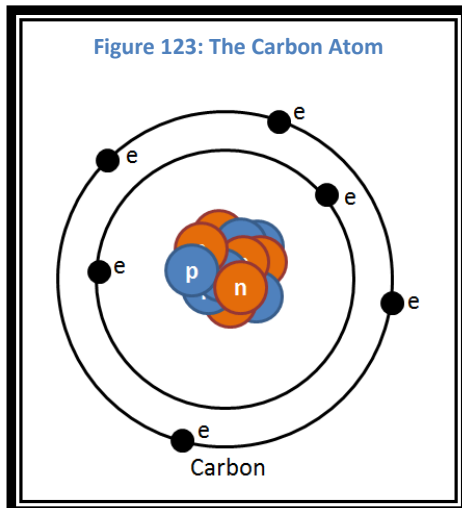
Photons are the particles that transmit energy of the electromagnetic force. But where do photons come from? Photons are created by vibrating charged particles: electrons and protons. Photons of different frequencies come from different sources.



### Electron Energy States

Electrons surround the nucleus of atoms. Different atoms have different numbers of electrons. It is easiest to understand how these electrons behave if we start with the simplest atom of all, Hydrogen.

Hydrogen has one electron and one proton. The electron does not orbit the nucleus like a planet orbits the sun, but it exists in a shell surrounding the nucleus.



For comparison, Carbon has 6 protons, 6 neutrons, and 6 electrons. The electrons exist in two shells.

**Ground State and Excited States.** When you have more electrons you have more shells. Each of these shells represents an energy level. In an undisturbed atom the electrons will be in their lowest energy state, their **Ground State**. But when photons with just the right amount of energy impact the electrons they are absorbed and the electron will move to a higher energy state, and **Excited State**. There is an unlimited number of these Excited States. There is also one ultimate state,

where the electron is ejected from the atom. This is called Ionization.

**Photon Emissions.** When an electron drops from an Excited State to a lower Excited State or to the Ground State it emits a photon. Each photon for every jump by each electron in each atom has a unique frequency.

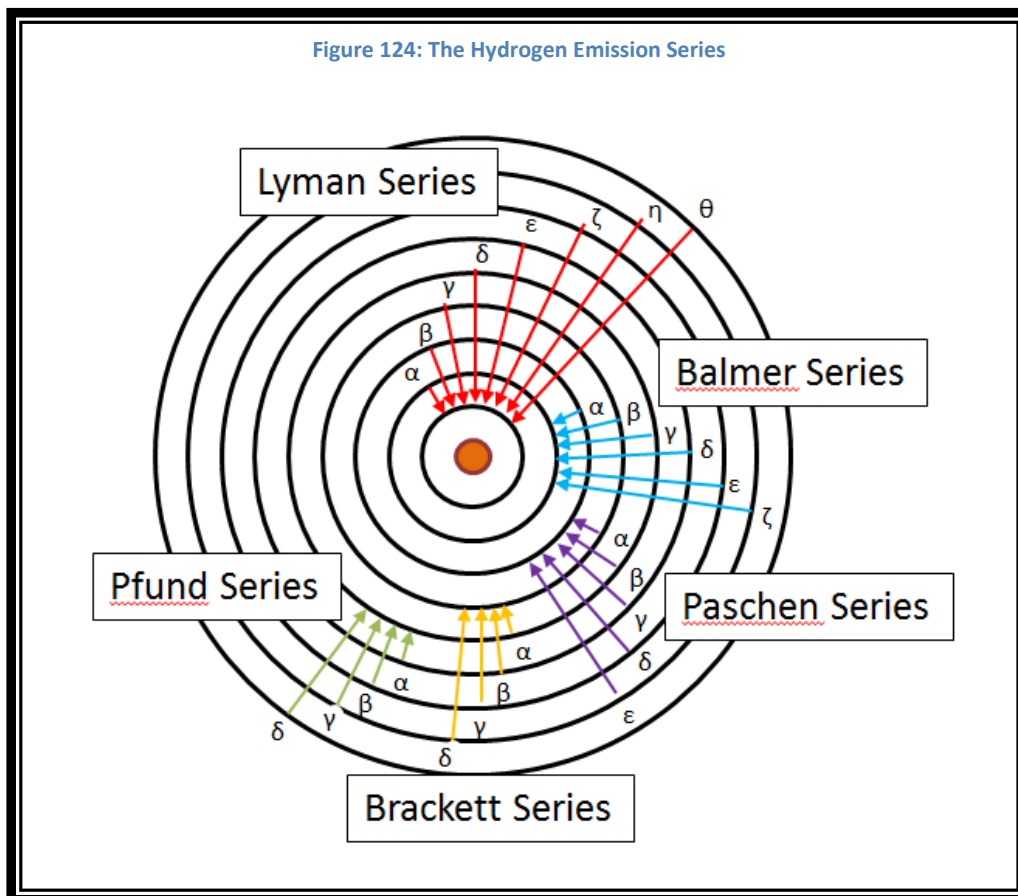
*Not all photons emitted by atoms are Visible Light*

Electrons, on their way back to the Ground State may either jump to it **directly**, or they may **cascade** through multiple jumps. Each jump can be through one or more energy states. Each jump emits a photon.

*Photons returning to the Ground State may jump Directly to the Ground State, or they may Cascade through multiple jumps*

**Hydrogen Electron Transition Series.** There are groupings of the transitions based on the destination of the jumps. These are called series, and some of them have specific names.

- Lyman Series – Jumps ending in the Ground State (infrared)
- Balmer Series – Jumps ending in the 1<sup>st</sup> Excited State (visible light)
- Paschen Series – Jumps ending in the 2<sup>nd</sup> Excited State (ultraviolet)
- Brackett Series – Jumps ending in the 3<sup>rd</sup> Excited State (ultraviolet)
- Pfund Series – Jumps ending in the 4<sup>th</sup> Excited State (ultraviolet)
- Humphreys Series – Jumps ending in the 5<sup>th</sup> Excited State (ultraviolet)



*The two that you should know by name are the Lyman Series and the Balmer Series*

The concept continues to higher levels as well, but they do not have specific names.

Transition for electrons in the hydrogen atom can be calculated. Since there is only one electron in the atom the process is rather simple.

To do this, use **the Rydberg Formula**.

Equation 4: The Rydberg Formula

$$\lambda = \frac{1}{R * \left( \left( \frac{1}{n1^2} \right) - \left( \frac{1}{n2^2} \right) \right)}$$

$\lambda$  = Wavelength

R = Rydberg Constant:  $1.097 \times 10^7 \text{ m}^{-1}$

n1 = Final Energy State

n2 = Initial Energy State

Table 6: The Greek Alphabet

$\alpha$ - alpha	$\nu$ - nu
$\beta$ - beta	$\xi$ - xi
$\gamma$ - gamma	$\omicron$ - omicron
$\delta$ - delta	$\pi$ - pi
$\epsilon$ - epsilon	$\rho$ - rho
$\zeta$ - zeta	$\sigma$ - sigma
$\eta$ - eta	$\tau$ - tau
$\theta$ - theta	$\upsilon$ - upsilon
$\iota$ - iota	$\phi$ - phi
$\kappa$ - kappa	$\chi$ - chi
$\lambda$ - lambda	$\psi$ - psi
$\mu$ - mu	$\omega$ - omega

To use this formula you need to input the two Energy States. For the Ground State use  $n = 1$ . For the 1<sup>st</sup> Excited State use  $n = 2$ . For the 2<sup>nd</sup> Excited State use  $n = 3$ , etc.

Example 1: The Rydberg Formula, an Example

The name of the Series tells you the Final Energy State. Lyman = 1, Balmer = 2, etc.

The Greek Letter tells you the Initial Energy State.  $\alpha$  = Series + 1,  $\beta$ - Series +2, etc.

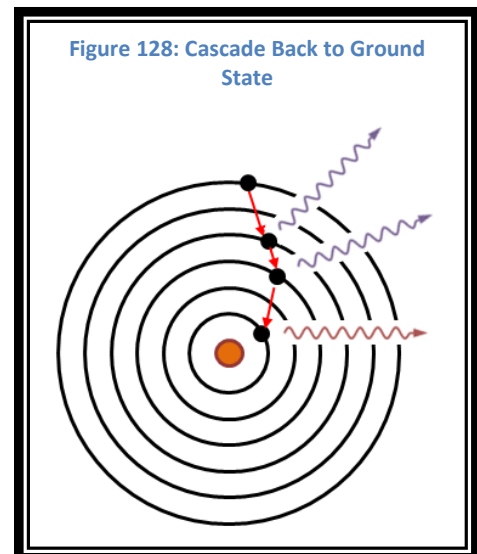
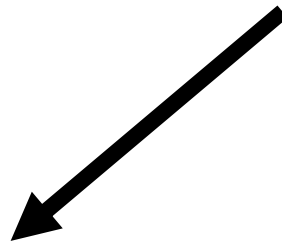
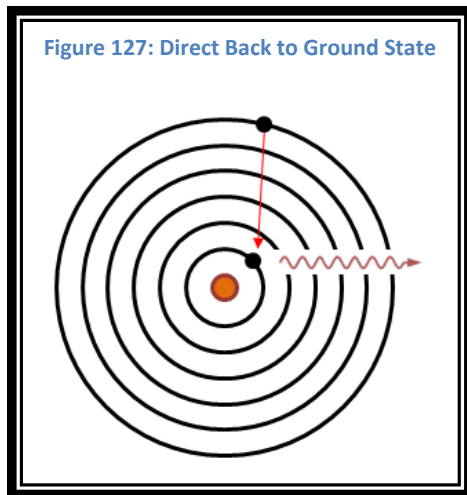
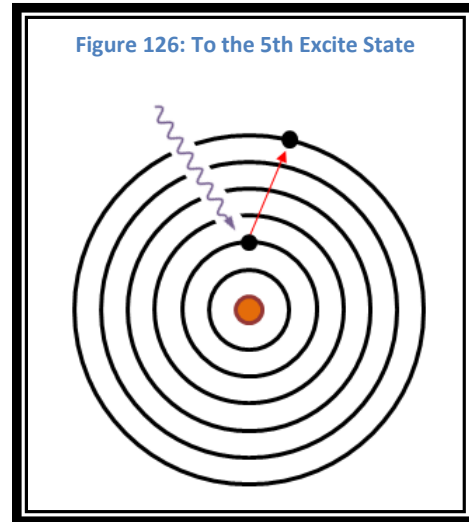
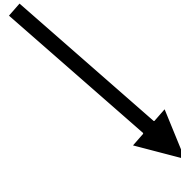
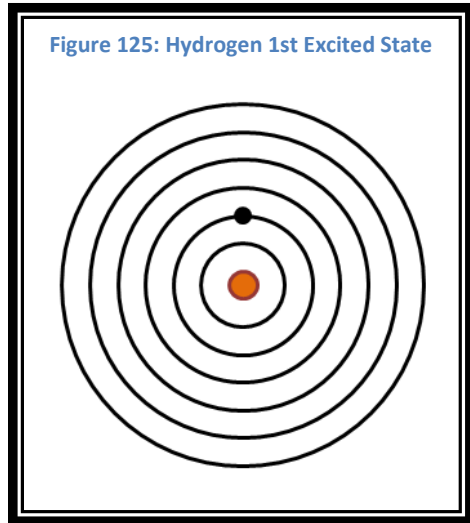
For the Balmer-Delta transition:                      N1 = 2                      N2 = 6

$$\lambda = \frac{1}{(1.097 \times 10^7) * \left( \left( \frac{1}{2^2} \right) - \left( \frac{1}{6^2} \right) \right)} = \frac{1}{(1.097 \times 10^7) * \left( \left( \frac{1}{4} \right) - \left( \frac{1}{36} \right) \right)}$$

$$\lambda = \frac{1}{(1.097 \times 10^7) * \left( \frac{8}{36} \right)} = \frac{1}{(1.097 * 10^7) * 0.2222} = \frac{1}{0.2438 * 10^7}$$

$$\lambda = 4.102 * 10^{-7} \text{ m} = 410.2 \text{ nm}$$

A photon of that wavelength that impacts the hydrogen electron will cause that electron to jump from the 1<sup>st</sup> Excited State to the 5<sup>th</sup> Excited State. If the electron then jumps back directly to the 1<sup>st</sup> Excited State, it will emit that same wavelength photon.



## Component 28 – Black Body Curves

In the ideal case, an object with a temperature radiates a continuous spectrum in the shape of a **black body curve**.

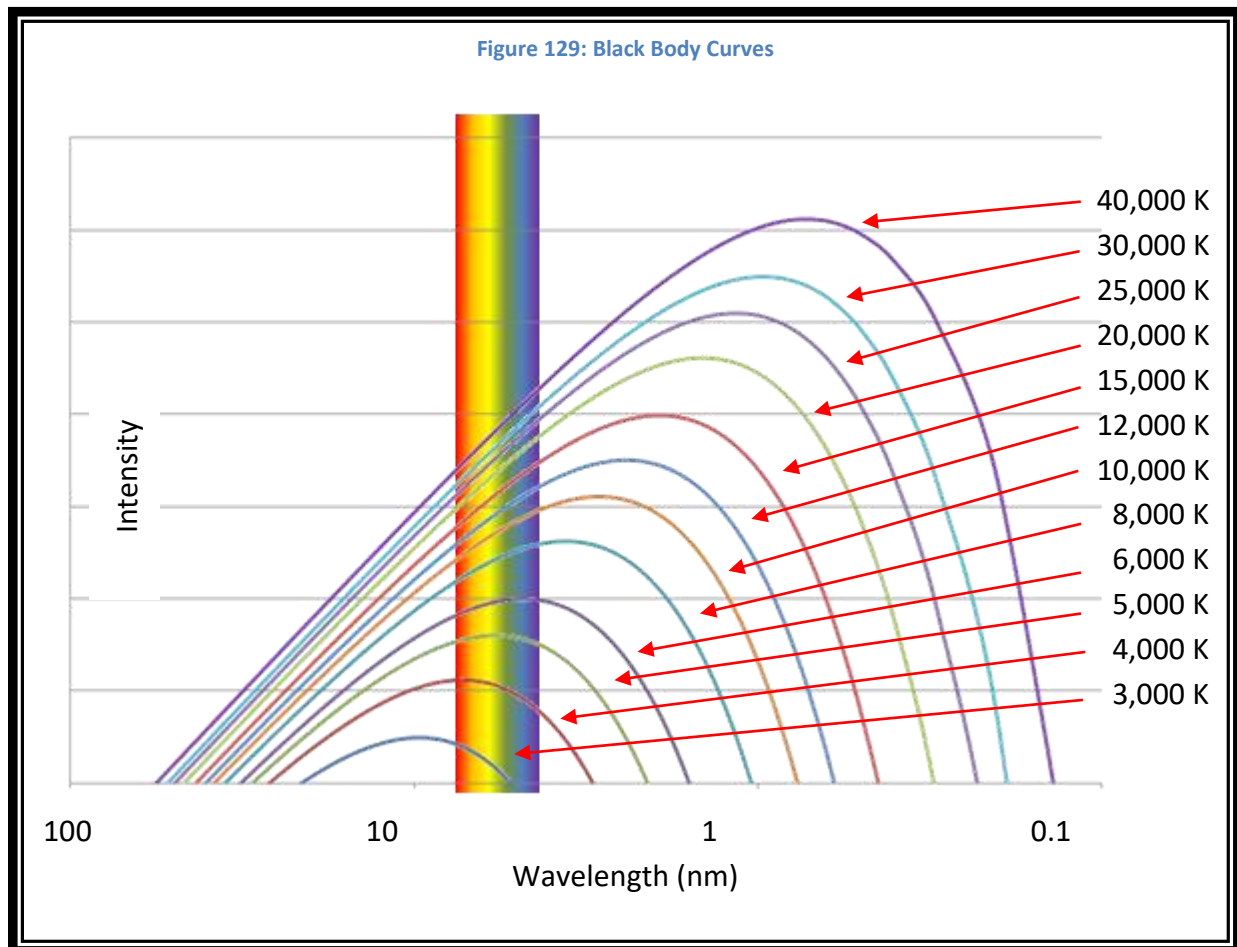
### Blackbody Curves

As the temperature of an object increases, the curve changes:

- Total area under the curve; **total energy** emitted increases.
- Peak **intensity** gets higher.
- Peak **frequency** gets higher.
- Peak wavelength gets shorter.

*As temperature rises...*

- *Peak Intensity Increases*
- *Peak Frequency Increases*
- *Total Energy Emitted Increases*





## Temperature Scales

In astronomy, temperatures are most often shown in Kelvin (K). In the United States, temperatures are most often shown in degrees Fahrenheit (°F). Much of the world uses degrees Celsius (°C).

Celsius and Kelvin are the same temperature scale, but Kelvin is 273° more than Celsius. Fahrenheit is a bit more complicated.

*Astronomers measure temperatures in Kelvin*

### Equation 5: Converting Between Temperature Scales

$$T_C = T_K - 273 \quad \text{or} \quad T_K = T_C + 273$$

$$T_C = \frac{(T_F - 32) * 5}{9} \quad \text{or} \quad T_F = \frac{(T_C * 9)}{5} + 32$$

Water freezes at 32° F. This is equal to 0° C or **273** K.

Water boils at 212° F. This is equal to 100° C or **373** K.

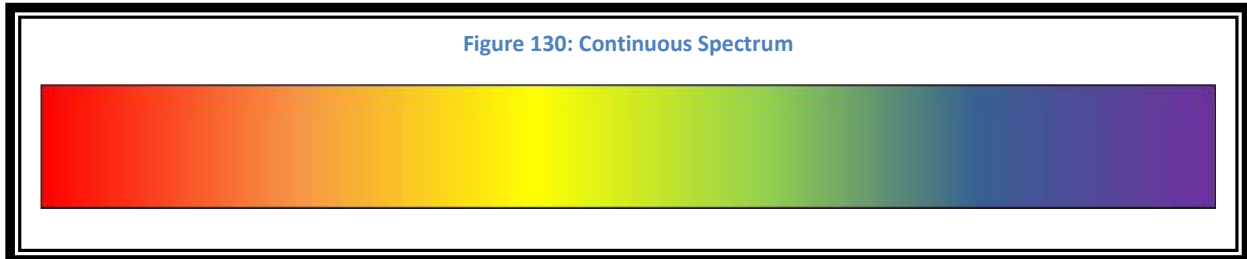
Absolute zero, the point where all motion stops, is **0** K. This is equal to -273° C or -459° F.

Hydrogen fusion occurs at **10 million**° C. This is equal to 10,000,273 K or 18,000,032° F.

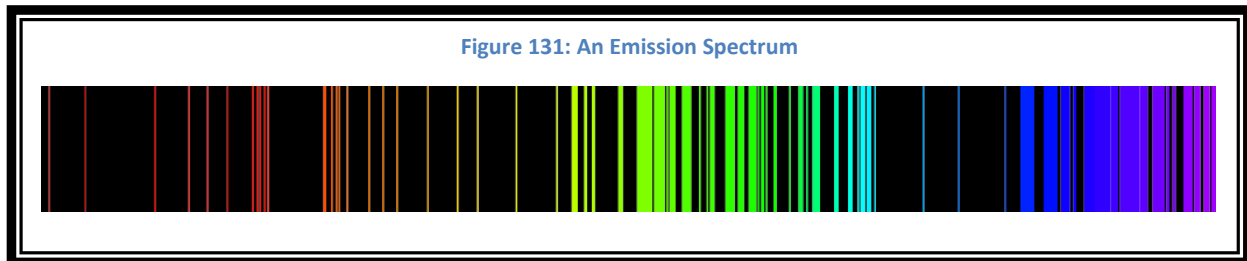
## Component 29 – Kirchhoff's Laws

Gustav Kirchhoff noticed that there was a relationship to spectra observed and their path to us. He summarized his findings in **Kirchhoff's Laws** Governing the Formation of Spectra. His laws state:

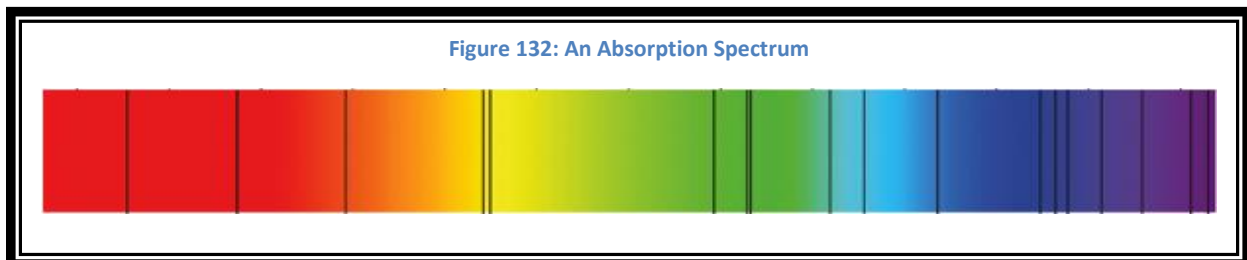
1. **First Law:** A hot solid, liquid, or dense gas will emit a **Continuous Spectrum**.



2. **Second Law:** A low density gas will emit light in a spectrum that has bright lines that are specific to the elements and molecules in that gas. These are **Emission Lines**.

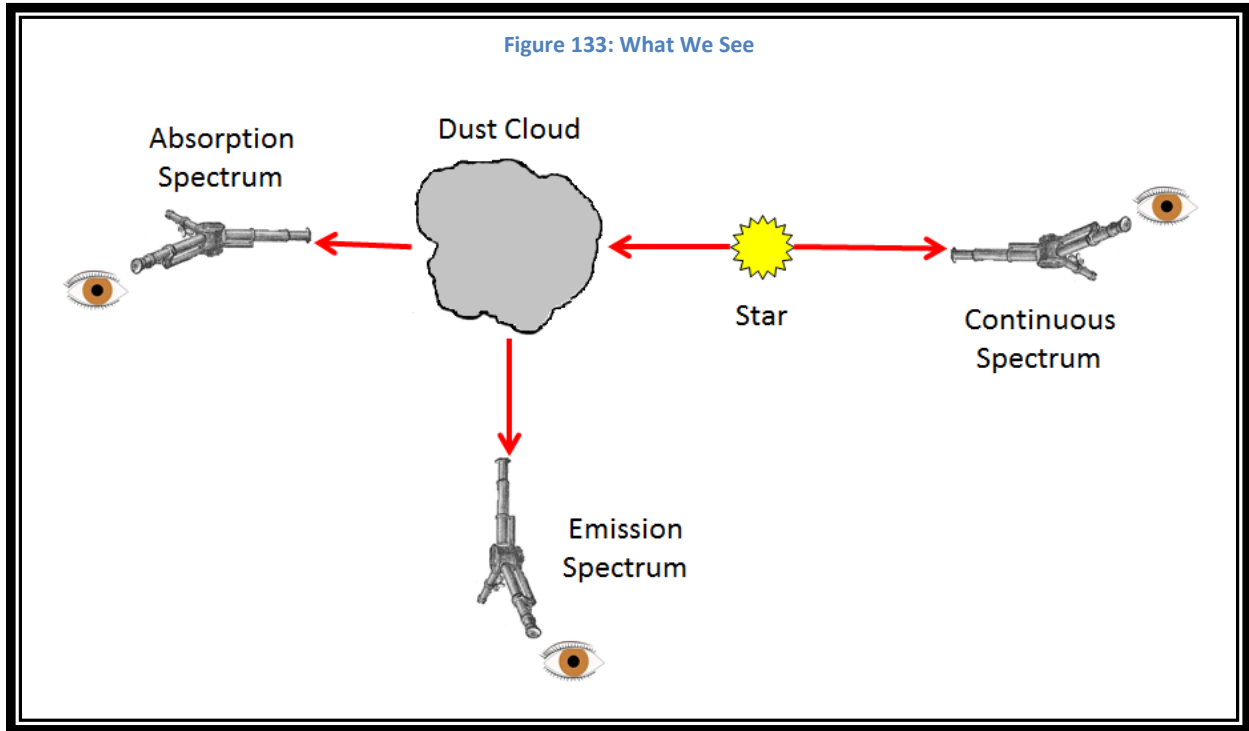


3. **Third Law:** A Continuous Spectrum that travels through a cool thin gas will have dark lines that are specific to the elements and molecules in that gas. These are **Absorption Lines**.



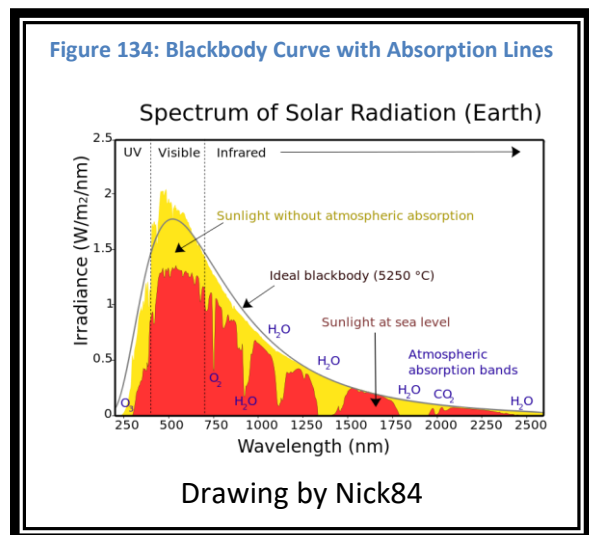
The application of this to astronomy is that we can learn information about the source and the history of light from distant objects by examining their spectra.

*Kirchhoff's Laws define the type of spectrum we see*



The observer on the left would see an Absorption Spectrum because the dust in the cloud would remove specific frequencies from the light reaching the Earth. The observer at the bottom would see some of those frequencies reemitted in their direction as bright lines of an Emission Spectrum. The observer on the right would see the continuous spectrum of the star because there is no intervening gas and dust cloud.

When we examine spectra seen on Earth some of the frequencies are absorbed by the atmosphere. The yellow in the drawing represents the spectrum of the Sun as it is emitted from the Sun before it enters the Earth's atmosphere. The red in the drawing represents the spectrum as seen through the Earth's atmosphere. The black line represents the ideal blackbody curve for an object the same temperature as the sun. This represents the image as seen by the observer on the left in the drawing above.

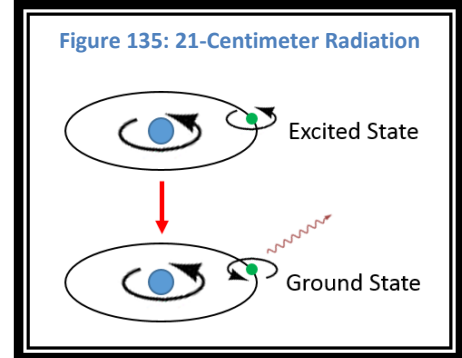


## Component 30 – More Energy States

As was noted previously, many bright lines seen in spectra come from photons emitted when an electron drops from an excited state to a lower level. But there are many more events which can cause a photon to be emitted.

### Atoms

Electron energy state changes can generate photons that are infrared, visible light, and ultraviolet. When you have more than one electron, you get bright lines from each of the electrons and there is an effect from other electrons in the atom. So unlike the Rydberg Formula that is useful for calculating the emission lines for hydrogen, a similar formula does not exist for other elements.

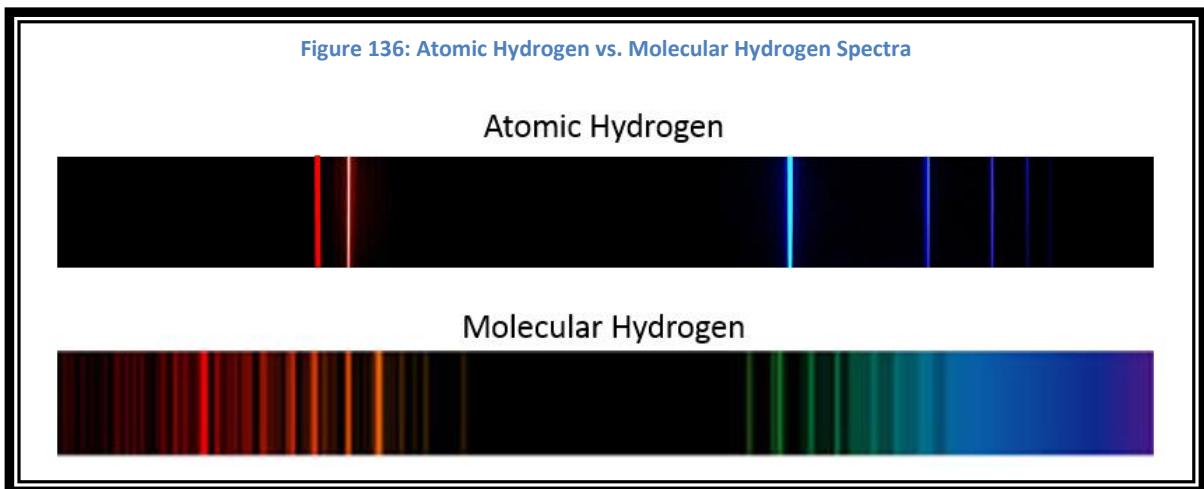


There is an additional form of radiation that is emitted when an electron that is excited with a spin that matches the proton in the hydrogen atom returns to ground state. It is called **21-Centimeter** Radiation. This is part of the Radio Spectrum.

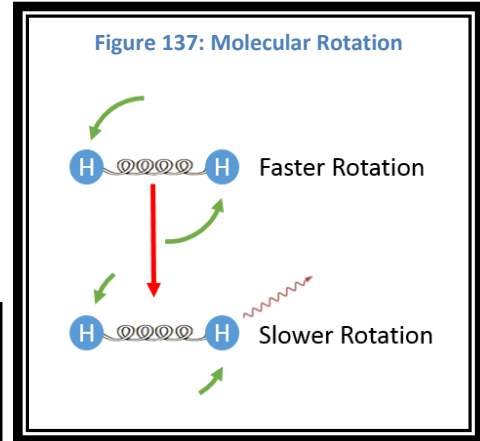
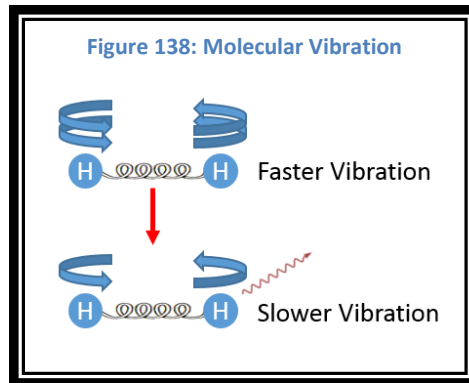
### Molecules

When you have atoms combined to form **molecules** there are more emission lines than you would expect from the atoms individually. The spectrum for molecules is more complex than for atoms.

*The Emission Spectra for Molecules is More Complex than for Atoms*



Molecules also have preferred states for their **rotation** and **vibration**. When they are excited and return to the ground state they emit a photon. A change to a lower energy state in Rotation will emit a photon in the **Radio** part of the spectrum. A change to a lower energy state in Vibration will emit a photon in the **Infrared** part of the spectrum.



*Molecules emit photons when:*

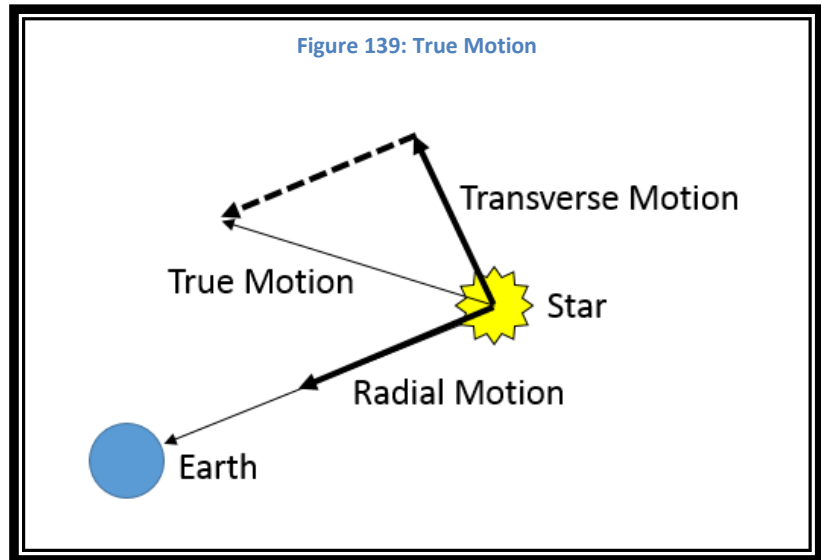
- *their vibration state returns to the ground state*
- *their rotation state returns to the ground state*
- *the rotation direction for their electron returns to the ground state*

## Component 31 – The Doppler Effect

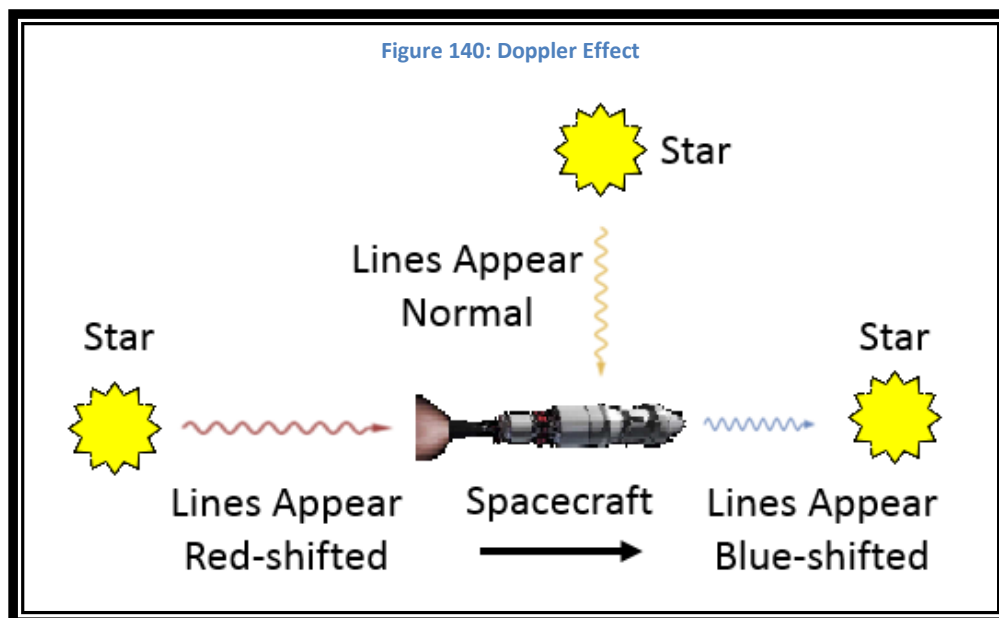
There are times when astronomers look at lines in spectra, and they are not at the frequency that they should be. Sometimes they are moved toward the red end of the spectrum, and sometimes they are moved towards the blue end. This is due to radial motion of the object being observed.

### Radial Motion

**Radial Motion** is the movement of an object towards or away from the observer. It is one part of True Motion. The other component of True Motion is Transverse Motion. We can measure Transverse Motion by taking images at two different times and measuring the movement of the star over the time between the images.



### Doppler Effect



As a spacecraft is moving, the light from the stars in front of the ship appears to be shifted toward the blue end of the spectrum (**blueshift**). This is because as each crest arrives at the spacecraft the spacecraft has moved a little closer towards the star. The crests arrive faster than they should. They are closer together, the **frequency** is higher, and appears to have moved in the blue direction.

*The Doppler Effect is a change in frequency due to radial motion. It lets us calculate an object's radial velocity.*

Light from the stars behind the ship appears to be shifted toward the red end of the spectrum (**redshift**). This is because as each crest arrives at the spacecraft the spacecraft has moved a little

further away from the star. The crests arrive slower than they should. They are further apart, the frequency is lower, and appears to have moved in the red direction.

Equation 6: Doppler Effect Calculation

$$\text{Recession Velocity} = \frac{(\text{Apparent Wavelength} - \text{Actual Wavelength}) * c}{(\text{Actual Wavelength})}$$

**Recession Velocity** = how the object is moving away from you.

Actual Wavelength = the wavelength that the object should be displaying.

Apparent Wavelength = the wavelength that the object appears to have.

C = the speed of light.

This is the same effect we hear with sound waves. Police sirens, train whistles, and other noises change from a higher frequency as the object is approaching to a lower frequency after the object has passed. We use the Doppler Effect in our daily lives when the Police use radar detectors to measure our speed, and when the weathermen measure the motion of raindrops in a thunderstorm.

We use a common line in the spectra with a known wavelength, such as the Balmer Series Hydrogen-Alpha: 656.3 nm. We measure the apparent wavelength from the lines that appear in spectra.

We can then combine this radial velocity with the transverse velocity that we can measure from images and we can calculate the object's true motion.

## Component 32 – The Language of Light

There are many things that we can learn about an object by studying its spectrum. This is a summary of the things we can measure and what they tell us.

**Peak Frequency** – the **Temperature** of the object.

By determining the peak frequency of the light emitted from an object we can tell its surface temperature. Some stars are so hot that their peak temperature is not in the visible part of the spectrum; it is in the ultraviolet.

**Doppler Shift** – the **Recession Velocity** of the object.

A change in the frequency of known lines in the spectrum tells us the recession velocity of the object. This is especially useful when combined with Hubble's Law for distant galaxies.

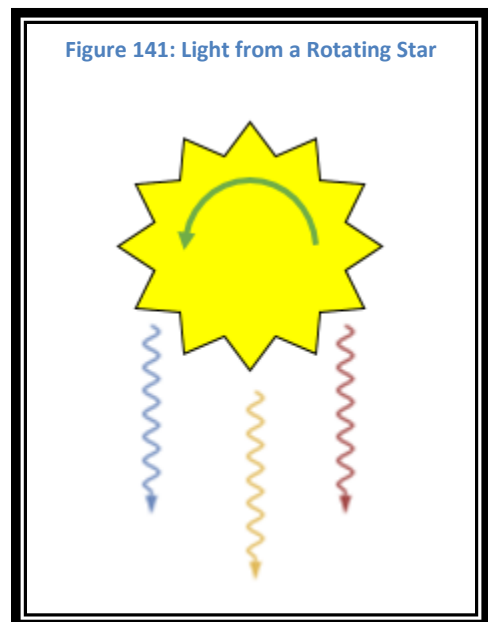
**Presence of Lines** – the **Composition** of the object.

Every element has a unique signature; a unique set of lines. By deciphering those lines it is possible to identify individual elements and molecules present in the object or an intervening dust cloud. These lines may be present outside of the visible part of the spectrum. They could be radio, infrared, visible, or ultraviolet.

**Width of the Lines** – **Rotation, Temperature, Turbulence, Magnetic Field.**

Lines have different widths depending on the environment where they were born. Many different factors have an impact on line width. If an object is rotating, one side of the object will be red-shifted. The other side will be blue-shifted. These effects from across the disk of the object combine to create broader lines centered on the frequency of the line. Higher temperatures cause the atoms and molecules to move faster. If they are moving away from the observer when they emit their photons then the light will be red-shifted.

Otherwise they will be blue-shifted. The combination of all these photons will yield a broader line. Turbulence works the same way. Magnetic fields have the effect of creating multiple lines for each transition. Often these lines are so close together that they appear as broader lines.





## Component 33 – How Far is That?

Measuring the distance to an object is an important part of astronomy. Depending on how far away the object is, different techniques are needed to measure the distance. On Earth, we can use a tape measure to determine a distance, but sometimes the distances are still too great to measure them manually. When this is the case, there are technological solutions we can use. There are also many different techniques for measuring astronomical distances.

### The Distance Tools

We will discuss 7 different techniques used to measure astronomical distances.

**Table 7: Measuring Astronomical Distances**

Technique	Minimum Distance	Maximum Distance
<b>Radar</b>	0	10 AU
<b>Stellar Parallax</b>	0	660 light-years
<b>Spectroscopic Parallax</b>	0	66,000 light-years
<b>Cepheid Variable Stars</b>	100 light-years	10 million light-years
<b>Tully-Fisher Relation</b>	1 million light-years	1 billion light-years
<b>Type Ia Supernovae</b>	1 million light-years	3.3 billion light-years
<b>Hubble's Law</b>	660 million light-years	(no upper limit)

### Inside the Solar System

Table 7 shows the distances that are measurable by each of the techniques we will discuss. Inside the solar system we measure distances in AUs. The Oort Cloud, in the most distant reaches of the solar system, is at a distance of roughly a light-year. This means that **Radar** and **Stellar Parallax** will meet our needs.

#### Equation 7: Measuring Distance with Velocity

Velocity:

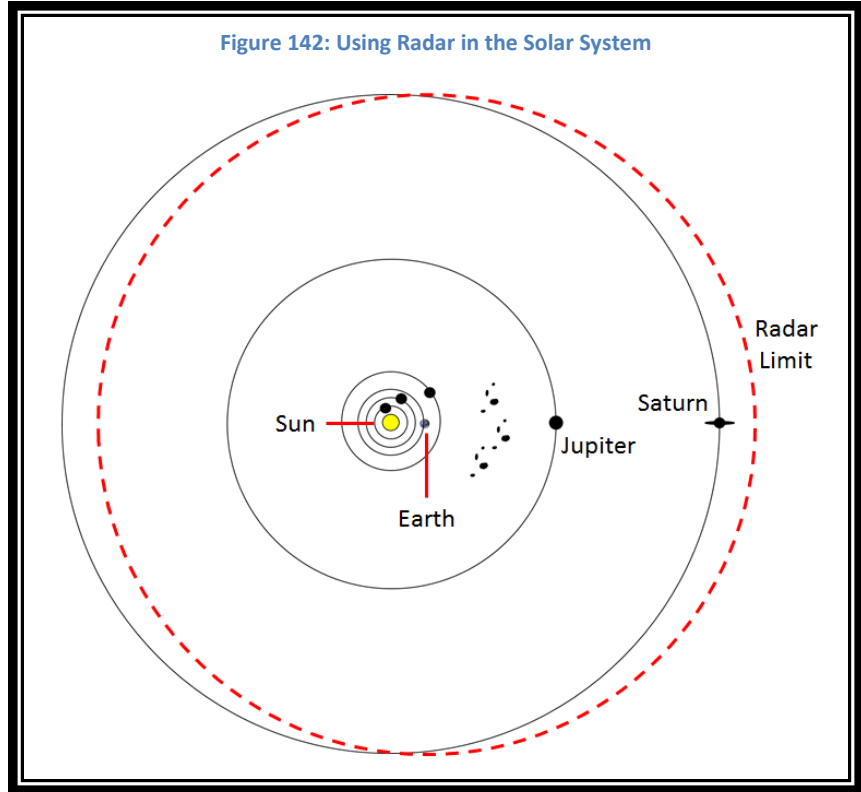
$$Velocity = Distance * Time$$

Distance:

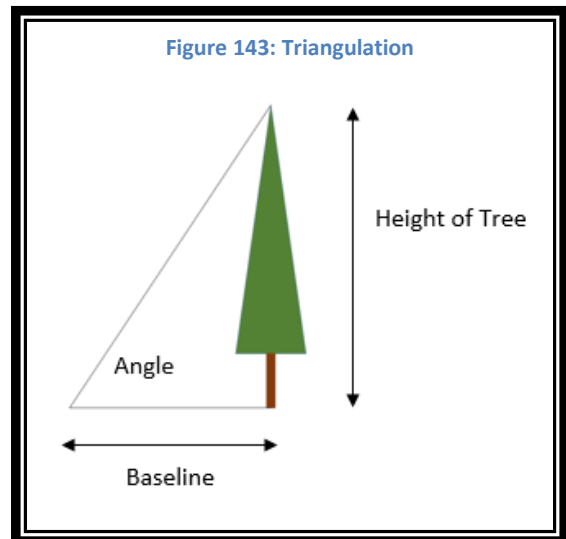
$$Distance = \frac{Velocity}{Time}$$

Velocity is the Speed of Light

**Radar.** Radar transmits radio waves in the direction of an object. They bounce off that object and return in our direction. Since we know that radio waves travel at the speed of light, we can calculate the distance based on how long it takes the signal to return. In astronomy, radar will work for distances out to about ten AU. This would be a circle centered on the Earth reaching to Saturn. Mercury, Venus, Mars, and sometimes Jupiter are within the circle and we would be able to measure their distances from Earth.



**Stellar Parallax.** Stellar Parallax is based on a technique that we use on Earth to measure long distances in surveying: Triangulation. Triangulation and Stellar Parallax use trigonometry to measure the distance to a far object based on a measured baseline distance and a measured angle.



Example 2: Triangulation

We see a tree, and we want to know the height of the tree. Rather than climb the tree with a long tape measure, we will use Triangulation to determine its height. We measure the distance from the tree to where we will stand. This is the Baseline. Assume that this is 100 feet. We next measure the angular height of the tree from the horizon to its top.

$$\text{tangent}(\text{Angle}) = \frac{\text{Opposite Side}}{\text{Baseline Side}}$$

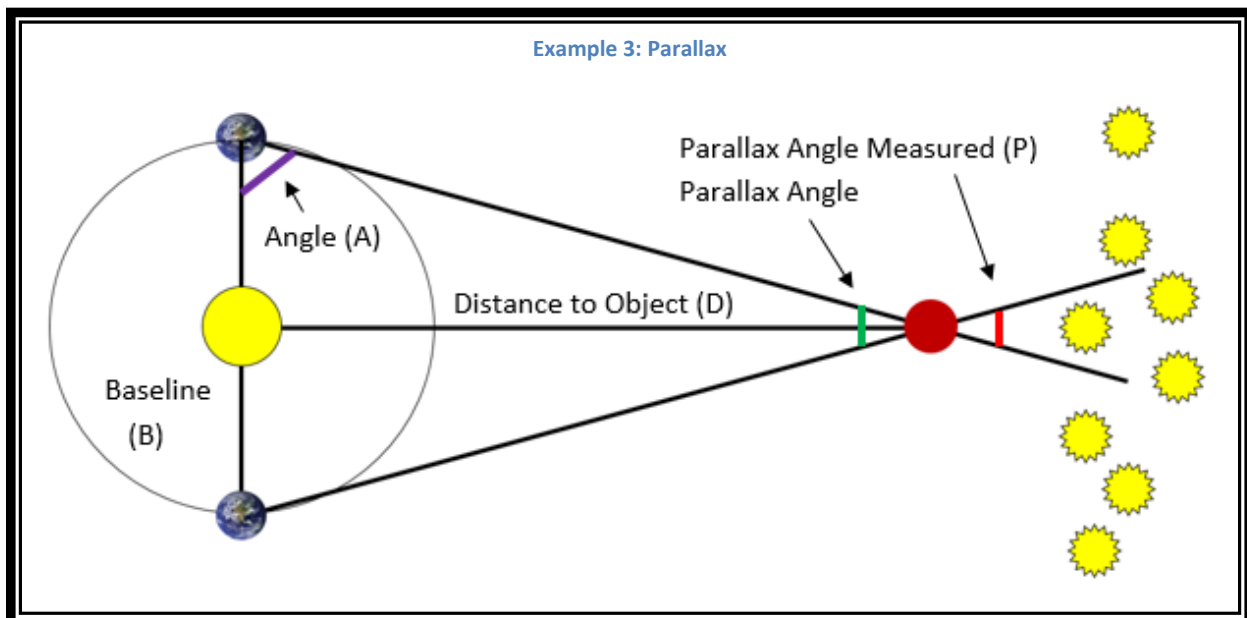
$$\text{Opposite Side (the Tree's Height)} = \text{tangent}(\text{Angle}) * \text{Baseline Side}$$

If the measured angle is 60°, then:  $\text{tangent}(60) = 1.7325$ .

The Tree's Height = 1.7325 \* 100 feet = 173 feet, 3 inches

Stellar Parallax, or simply Parallax, uses the mathematics of Triangulation. We can measure the distance to a distant object by taking a measurement of the angular displacement of a near object relative to the background stars.

We measure the angular difference in the sky based on the background stars from two



observations. The observations are made from opposite sides of the Earth's orbit, so the Baseline distance is 1 AU. (We will use only half of the Parallax Angle measured.) The larger the Baseline the more accurately we can measure the Angle.

The Baseline is half the distance between the two observing locations: B.

The Distance to the Object is the distance from the Sun to the Object: D.

The red Parallax Angle was measured (P). The green Parallax Angle is equal to the red one.

**Note:** The human eyes, at about 3 inches apart, are capable of doing Parallax out to about 600 feet.

**Equation 8: Measuring Distance with Parallax**

Angle:  $\alpha = 90^\circ - \left(\frac{P}{2}\right)$

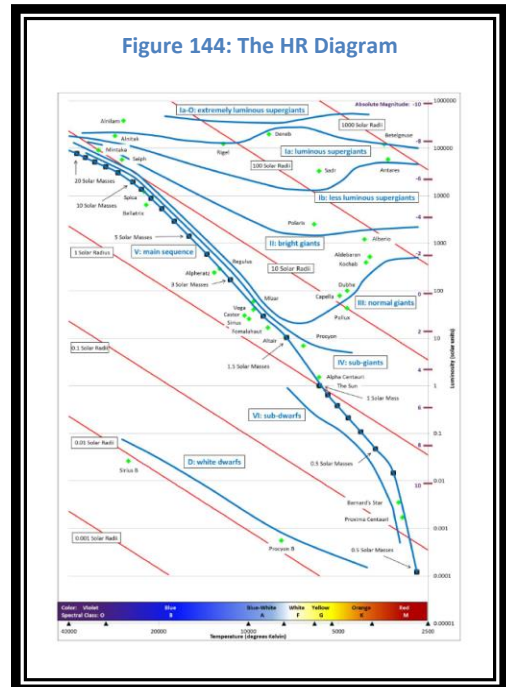
Distance:  $D = \text{tangent}(\alpha) * B$

**Beyond the Solar System**

As we move beyond the solar system, we need to employ new tools to increase the distances we can measure. We can still use **Stellar Parallax** to reach the closer stars, but to reach more distant stars and other deep space objects we need to use: **Spectroscopic Parallax, Cepheid Variables, The Tully-Fisher Relation, Type Ia Supernovae, and Hubble’s Law.**

**Spectroscopic Parallax.** Spectroscopic Parallax has nothing to do with the Parallax related to Triangulation. All stars can be placed on the **Hertzsprung-Russell Diagram (HR Diagram)** (see Figure ) based on their electromagnetic peak frequency and their intensity. Once placed on the HR Diagram, their location will tell us the Absolute Magnitude. When we observe the star, we can measure the Apparent Magnitude. Knowing these two values we can calculate the distance. (There will be more on HR Diagrams later.)

We use a formula called the Distance Modulus. This equation lets us input the values for the Apparent Brightness and the Absolute Brightness and results in the distance in parsecs.

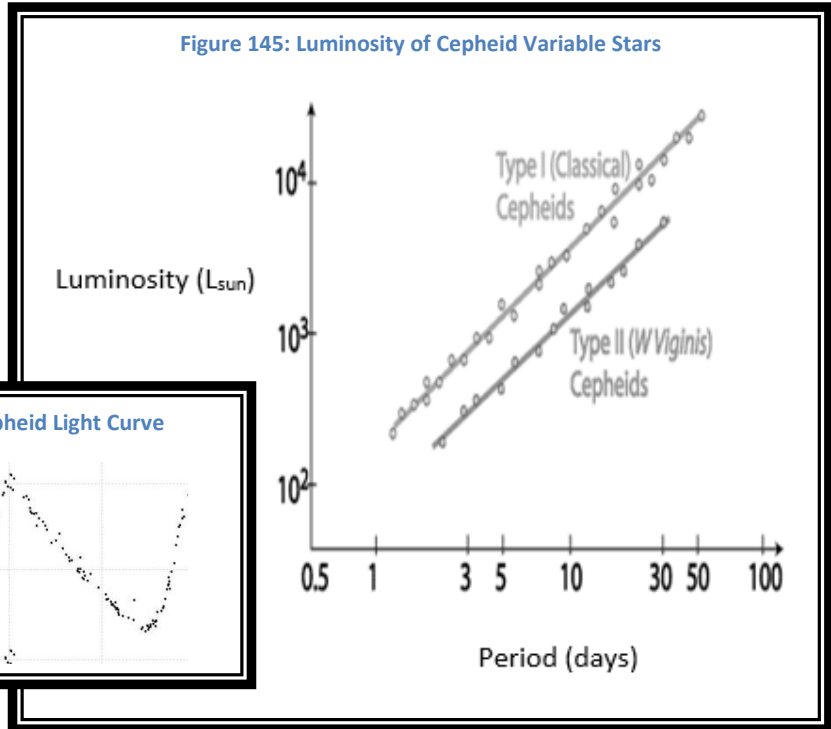
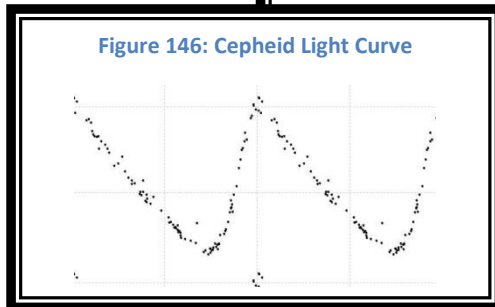


**Equation 9: The Distance Modulus**

$$D = 10^{(0.2 * (m - M + 5))}$$

m is the Apparent Brightness  
M is the Absolute Brightness

**Cepheid Variables.** Cepheid Variable Stars have a very characteristic light curve (see Figure ). They also have the unique characteristic that the variation period of their light curve is directly proportional to their Absolute Brightness.



Their variation period is from days to months. They are referred to as Standard Candles. This means that they can be used as a standard in measuring the distance to stars and galaxies.

**Tully-Fisher Relation.** The Tully-Fisher Relation is specifically suited to calculating the Luminosity of a spiral galaxy. You can then relate that luminosity to the apparent magnitude to determine the distance to the galaxy. The process looks at the width of the emission spectral lines. Rotation velocity directly relates to the width of those lines. Rotational velocity is an indication of the mass in the galaxy, and the more mass, the more stars. The more stars, the brighter the galaxy will be. First you must estimate the rotational velocity from the broadening of the bright spectral lines. Then you can use a formula to determine its luminosity based on that rotational velocity. Different frequencies have different constants, but for Red light the equation is shown in Equation 10.

Once you have the Absolute Magnitude to compare it to the Apparent Magnitude and use the Distance Modulus to calculate the distance.

**Equation 10: Measuring Luminosity with the Tully-Fisher Relation**

$$L = -8.09 * \log(\text{Rotation Speed} - 2.5) - 21.05$$

**Type Ia Supernovae.** Type Ia Supernovae are also known to be standard candles. Type Ia Supernovae are the result of a Carbon Detonation Supernova. It always has an absolute magnitude of -19.3. Once you have the Absolute Magnitude to compare it to the Apparent Magnitude, we can use the Distance Modulus to calculate the distance.

**Hubble's Law.** Hubble's Law is based on the red shift that is caused by the expansion of the universe. It works best for very distant objects. The reason for this is that the farther away the object is, the less impact its proper motion will have on the red shift, so the red shift will almost entirely be due to the expansion of the universe. The recession velocity can be calculated using the equations for the Doppler Effect (a later component) based on the shift in the spectral lines. The distance of the galaxy is calculated using Equation 11.

Equation 11: Measuring Distance with Hubble's Law

$$Distance = \frac{Recession\ Velocity}{H_0}$$

$H_0$  is the Hubble Constant = 67.8 (km/sec)/MPc

*Hubble's Law works better the farther away you are. The greater distance minimizes the effects of the objects true motion.*

## Component 34 – Redshifts

While it makes sense to talk about distances on Earth in terms of kilometers and miles, distances in the solar system in AUs, and distances between the stars in light-years and parsecs, when astronomers talk about very distant objects they often use the measurement of redshift. Red-shift is a function of the Recessional Velocity, which can be calculated based on the Doppler Shift in the wavelength of the light emitted by the object.

As we look at objects that are farther away, we have to take into account the time it took for the light to reach us. If it is receding from us, then during the time it took for the light to reach us, it has moved even farther away. To avoid any confusion when we talk about distances to these objects, it is simpler to refer to the apparent distance as the **Lookback Time**.

Equation 12: Red-Shift Calculation

$$V_R = \frac{\lambda_a - \lambda_A}{\lambda_A}$$

$$\text{Redshift} = \frac{V_R}{C}$$

C = The Speed of Light

$V_R$  = Recessional Velocity

$\lambda_a$  = Apparent Wavelength

$\lambda_A$  = Absolute Wavelength

Table 8: Red Shift vs. Look-Back Time

Red-Shift	$V_R$ (% of C)	Current Distance (ly)	Lookback Time (yrs)
0	0	0	<b>0</b>
0.01	1	$137 \times 10^6$	$137 \times 10^6$
0.025	2.5	$343 \times 10^6$	$338 \times 10^6$
0.05	4.9	$682 \times 10^6$	$665 \times 10^6$
0.1	9.5	$1,350 \times 10^6$	$1,290 \times 10^6$
0.25	22	$3,260 \times 10^6$	$2,920 \times 10^6$
0.5	38.5	$6,140 \times 10^6$	$5,020 \times 10^6$
1	60	$10,800 \times 10^6$	<b><math>7,730 \times 10^6</math></b>
2.5	85.1	$21,800 \times 10^6$	$11,200 \times 10^6$
5	94.5	$25,900 \times 10^6$	$12,500 \times 10^6$
10	98.4	$31,500 \times 10^6$	<b><math>13,200 \times 10^6</math></b>
25	99.5	$38,200 \times 10^6$	$13,490 \times 10^6$
50	99.9	$40,100 \times 10^6$	$13,600 \times 10^6$
100	100	$42,200 \times 10^6$	<b><math>13,800 \times 10^6</math></b>

## Component 35 – Extrasolar Planets

Extrasolar Planets or Exoplanets are planets that orbit around stars other than the Sun. The first one discovered was in **1992** using a technique called Timing. **5197** are confirmed (9/3/22)

### Transit

The most productive technique has used photometry to measure the dimming of a star as a planet passes in front of it.

Figure 148: Kepler Search Area

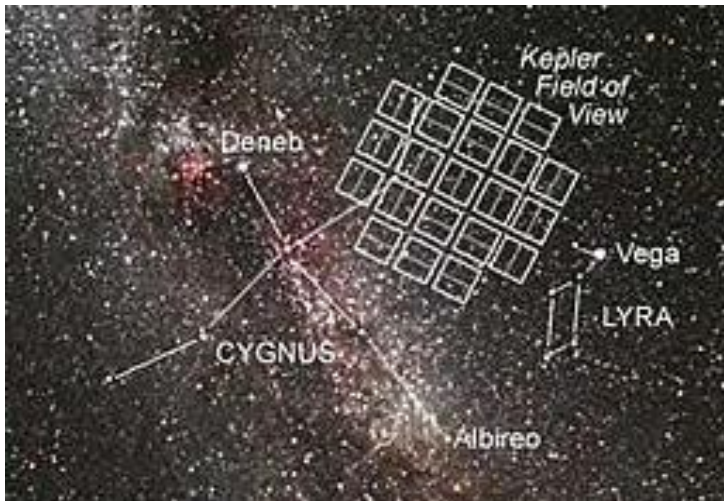


Figure 147: The Kepler Telescope



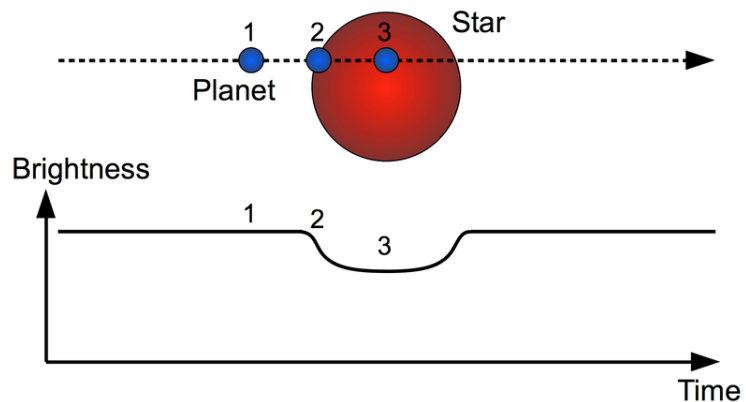
Although this has been done using telescopes on the Earth, most planets were found using the Kepler Telescope. As of the end of 2014, 231 planets were confirmed.

**The Kepler Telescope.** The Kepler Telescope observed the sky near the constellation Cygnus and was launched in 2009.

### Radial Velocity

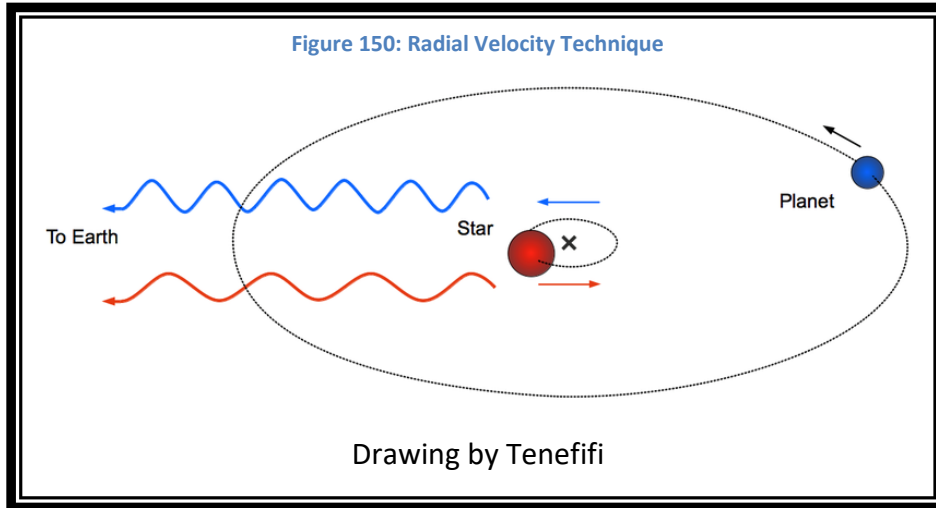
The second most productive technique has been the use of Doppler Shift to measure the radial velocity of a star; the “wobble” of a star caused by a planet orbiting it. As of the end of 2014, 30 planets were confirmed since 1996.

Figure 149: Planetary Transit Effect



Drawing by Hans Deeg

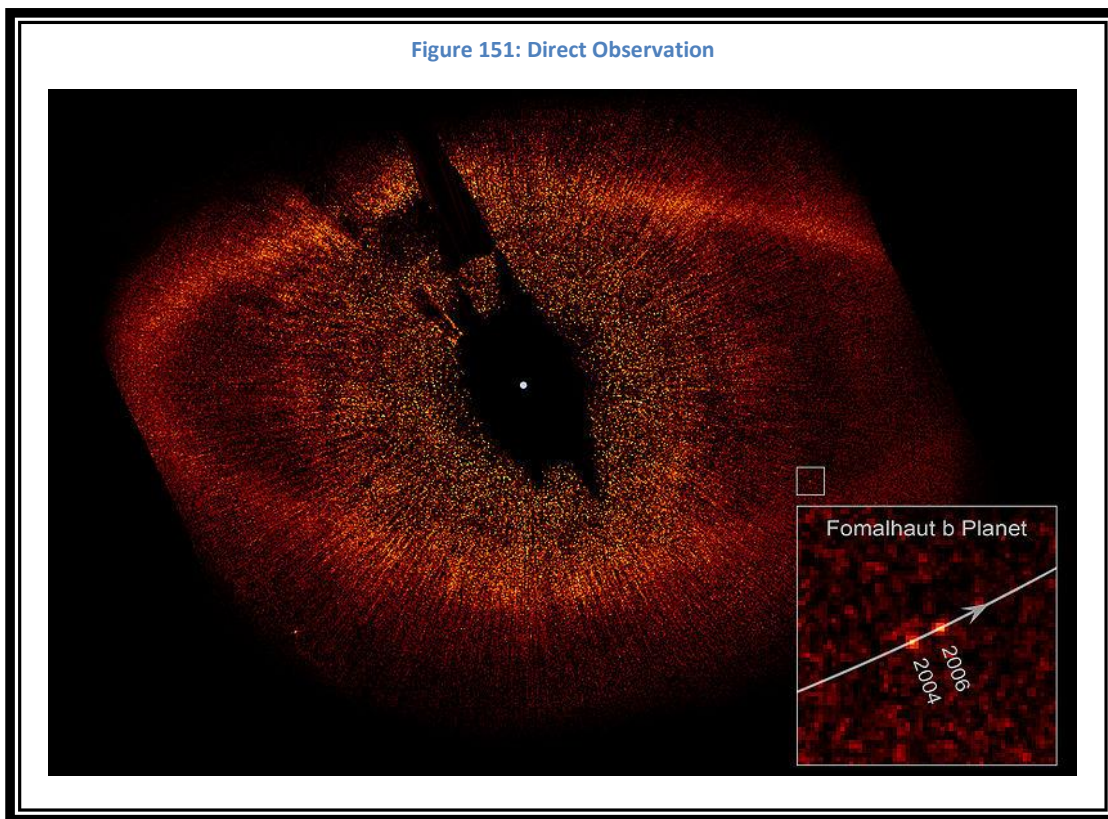




### Other Techniques

Three other techniques have been successful in discovering extrasolar planets: Direct Imaging, Microlensing, and Timing.

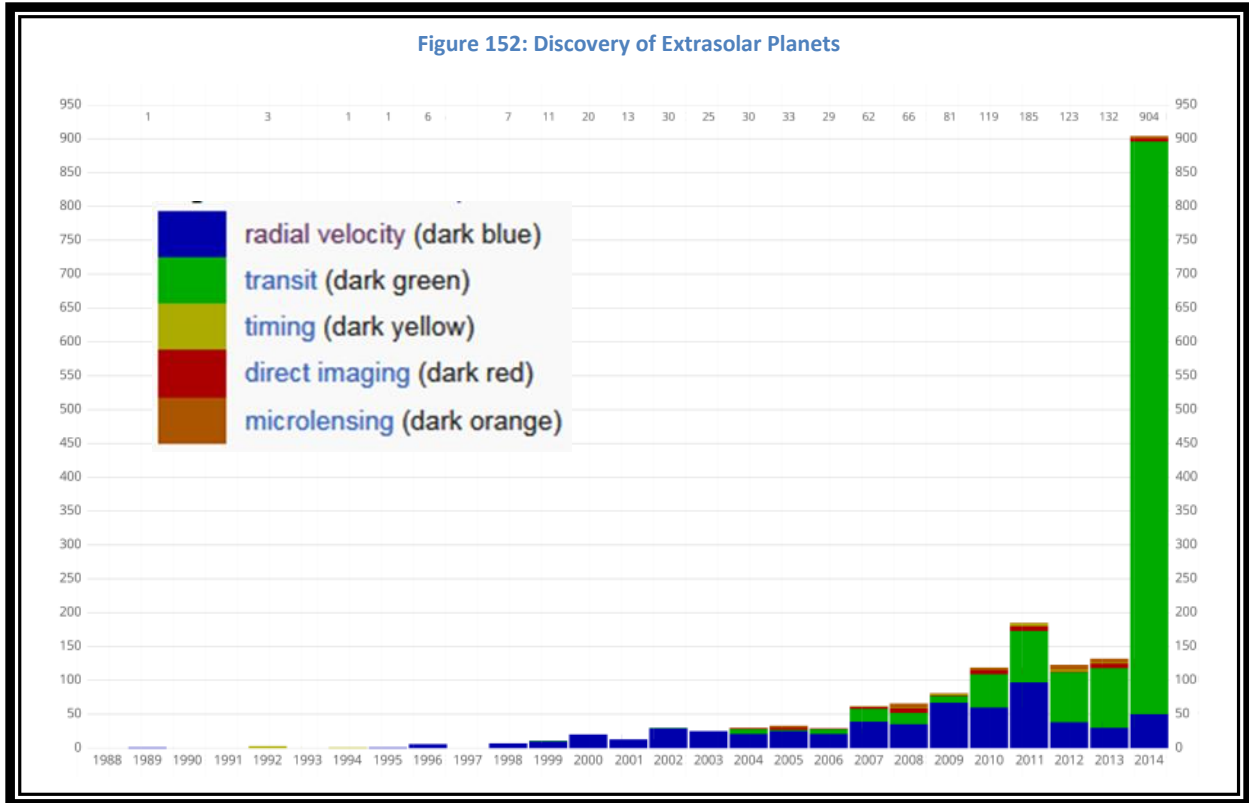
**Direct imaging.** Direct Imaging has identified 20 extrasolar planets since the first one was discovered in 2004.



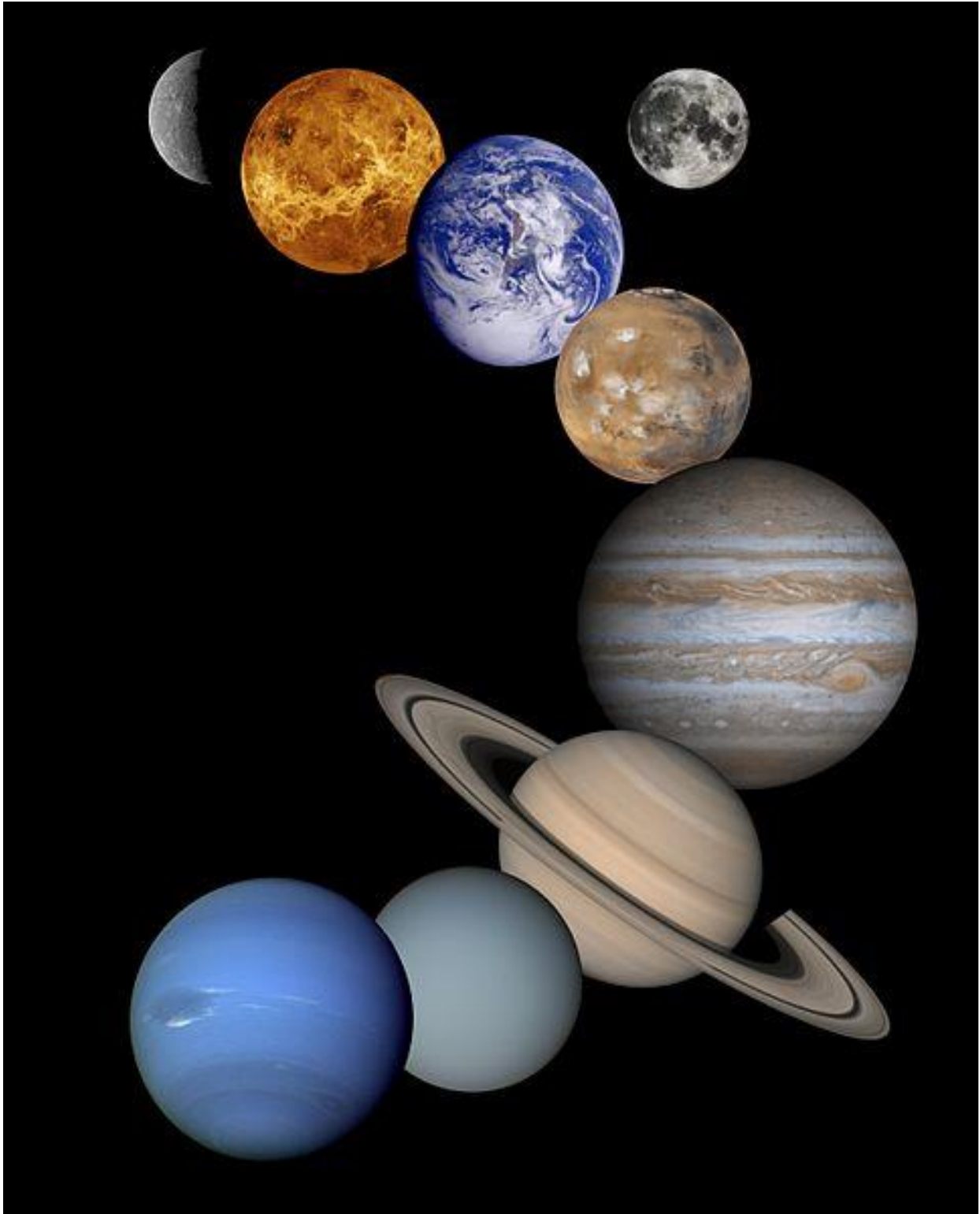
**Microlensing.** Microlensing has been used since 2004 and 19 extrasolar planets have been found. This technique observes a star in front of another star. Microlensing will make the background star appear brighter as light curves around the foreground star. If the foreground

star has a planet, then the background star appears even brighter due to the gravitational lensing.

**Timing.** The Timing technique has identified 16 extrasolar planets between the first in 1992 and 2014. The observations detect a change in the frequency of the brightenings of the object due to the existence of an extrasolar planet. Five of these were extrasolar planets orbiting pulsars, and 11 were extrasolar planets orbiting variable stars. This technique has done very well at identifying small extrasolar planets.



**\*\*\* SECTION IV. ASTRONOMY – THE SOLAR SYSTEM**

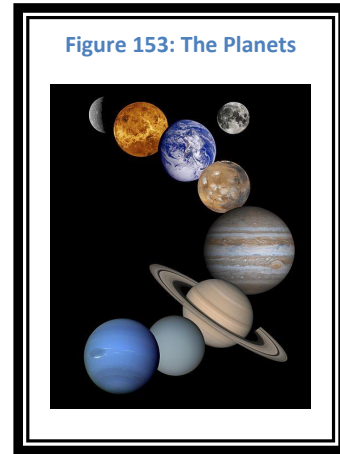


## Component 36 – Solar System Roll Call

The Solar System is composed of many bodies, large and small. It is helpful to understand how these objects relate to each other. The first step is to understand what objects are out there.

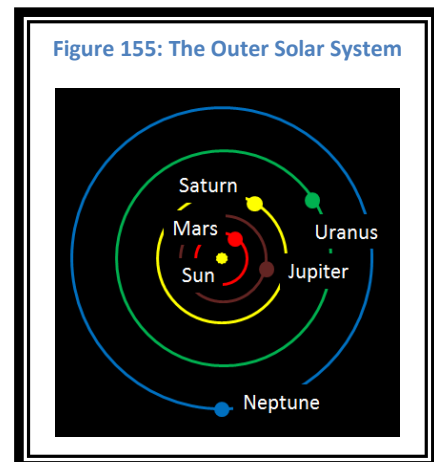
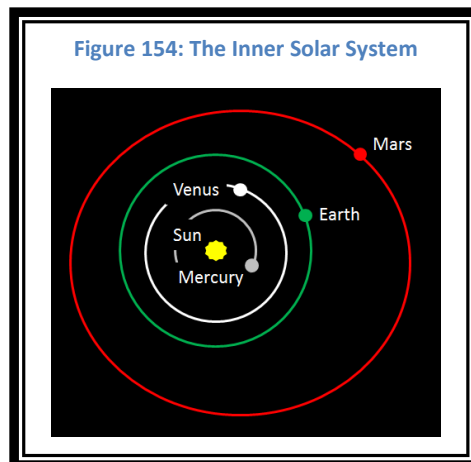
### Major Objects

**The Sun.** The most significant member of the family is the sun. The Sun is so large that it controls all of the other objects in the solar system through its gravity. The Sun is a star, similar to the many stars we see in the night sky, but it is much closer, and therefore much brighter.



**Planets.** There are 8 planets in the Solar System. In order starting closest to the sun, they are:

- **Mercury**
- **Venus**
- **Earth**
- **Mars**
- **Jupiter**
- **Saturn**
- **Uranus**
- **Neptune**



Planets are large objects. They can be broken into two categories:

- Terrestrial Planets
- Jovian Planets

The Terrestrial Planets are smaller rocky bodies like the Earth. The Jovian Planets are large and gaseous objects like the planet Jupiter.

**Dwarf Planets.** There are currently 5 Dwarf Planets. These are smaller than planets and have not met the requirements to be on the list of planets. Currently the list of Dwarf Planets is:

- **Ceres** (located in the Asteroid Belt)
- **Pluto** (located in the Kuiper Belt)
- **Haumea** (located in the Kuiper Belt)
- **Makemake** (located in the Kuiper Belt)
- **Eris** (located in the Scattered Disk)

**Minor Objects**

**Moons.** A moon is a body that orbits another body besides the sun. They can be fairly large, or they can be very small. They can orbit planets, dwarf planets, and even asteroids. Currently the planet Saturn has the most moons with 82, but Jupiter is close behind with 79. There are also over 400 known moons of asteroids.

Moons have formed in many different ways. Some appear to have formed at the time that the planets were forming and have internal structures similar to the planets. Others appear to be captured asteroids or Kuiper belt objects. The Earth’s Moon appears to have been formed from the debris of an impact by a large object with the Earth. The debris was ejected out of the Earth’s atmosphere and over time collected and contracted into the moon.

**Asteroids.** Asteroids are rocky or metallic objects larger than 100 yards in diameter. Most live in the Asteroid Belt between the planets Mars and Jupiter. Some do have orbits that have been changed by interactions with other asteroids and they may travel into the inner solar system

**Comets.** Comets are icy objects similar to dirty snowballs. They originated in the Kuiper Belt or the Oort Cloud, but their orbits have been modified to bring them into the inner solar system. As they approach the sun, the ices begin to turn into gases and these erupt from the surface of the comets. The result is often a grandiose pair of tails, one composed of charged particles, the other composed of dust particles

**Trans-Neptunian objects: Kuiper Belt Objects, the Scattered Disk Objects, and Oort Cloud Objects.** These objects are icy chunks from the days of the formation of the Solar System. They were ejected by the large planets to the Kuiper Belt, which is a large torus beyond the orbit of Neptune, or out to the Oort Cloud which is much further away. The Oort Cloud is a spherical cloud of these icy bodies. These are the places where the comets originate. The Scattered Disk is the area between the Kuiper Belt and the Oort Cloud.

**Meteoroids.** At the small end of the Solar System’s family are the meteoroids. There are rocky objects that are smaller than 100 yards in diameter. Many are the size of grains of sand. There are countless meteoroids in interplanetary space.

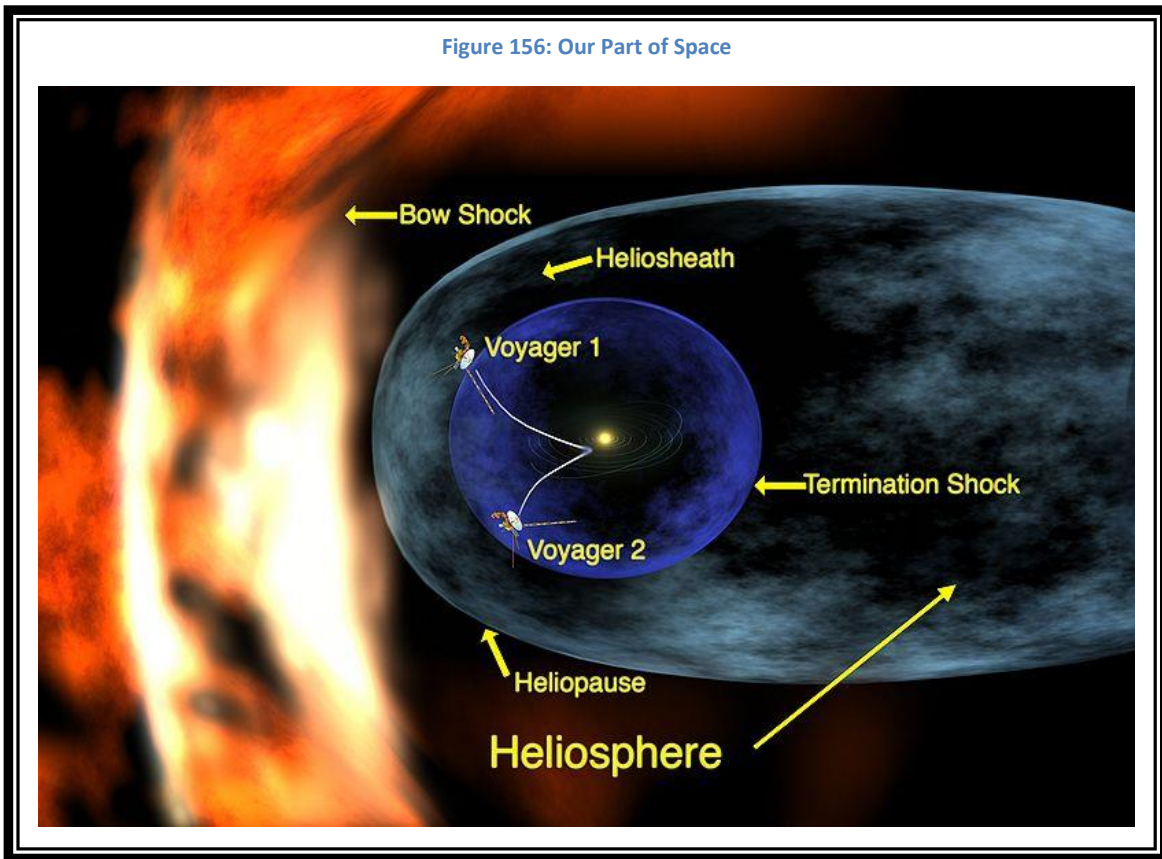
Mercury	0
Venus	0
Earth	1
Mars	2
Jupiter	79
Saturn	82
Uranus	27
Neptune	14
Ceres	0
Pluto	5
Eris	1
Haumea	2
Makemake	1
Asteroids	479
<b>TOTAL</b>	<b>693</b>

## Component 37 – Solar System Blueprint

Every star system is unique: different planets and different distances from the star. Our Solar System is unique. To fully appreciate the extent of the Solar System it is helpful to put objects in the relative positions.

### Starting With the Big Picture

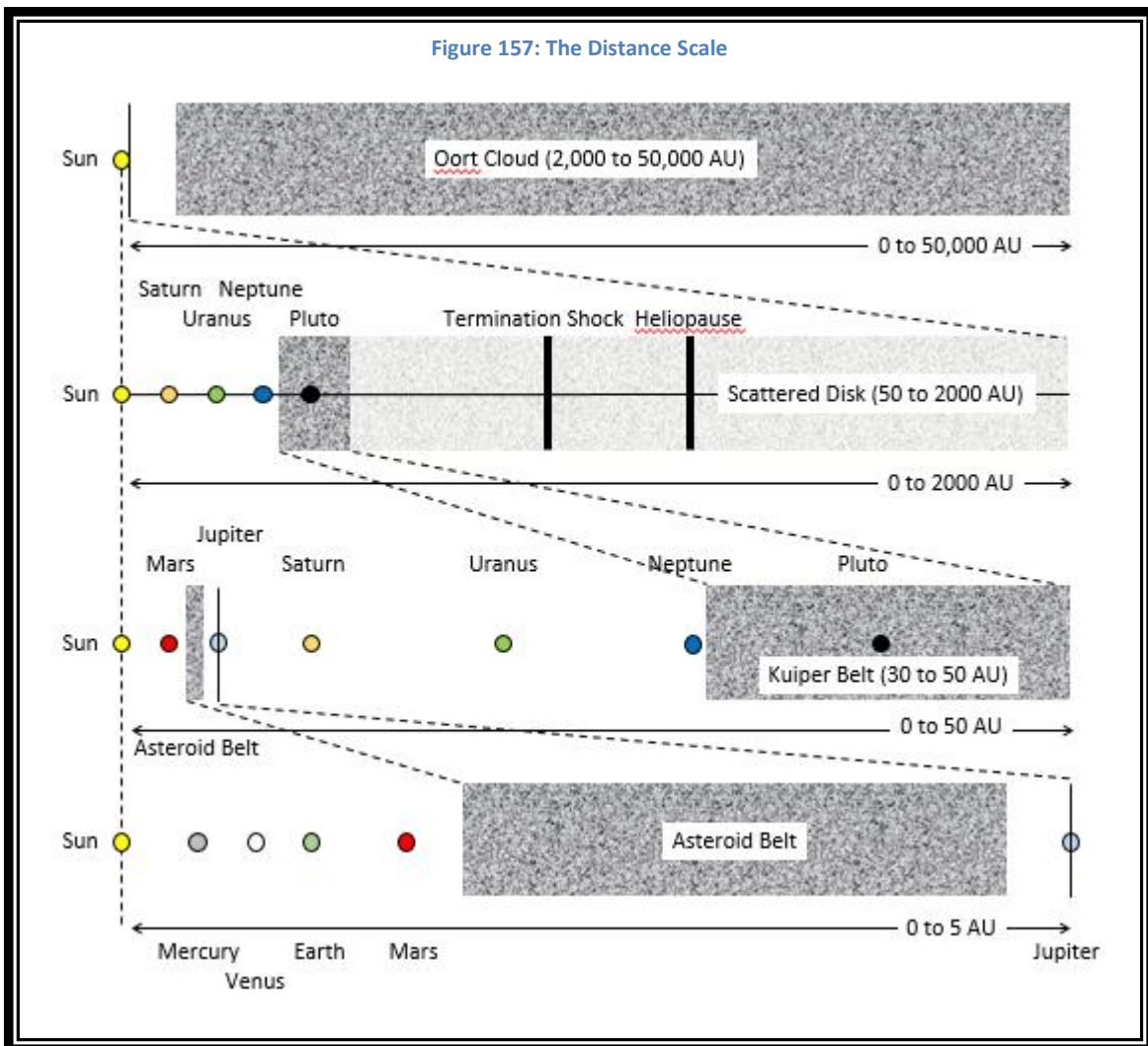
The Sun is moving through the Milky Way Galaxy. As it does, it runs into dust and gas that exists in the space between the stars; the interstellar medium. Like a boat moving through the water, this creates a **Bow Shock**. The Heliosphere is the region of space that is affected by charged particles flowing outward from the Sun; the solar wind. It is compressed by pressure



from the interstellar medium in front of the sun, and behind the Sun it is extended outward. This boundary is called the **Heliopause** (at 121 AU). There is also a **Termination Shock** (at 90 AU). This is the point where the solar wind abruptly drops to a very low speed. The Voyager 1 Spacecraft has crossed the Termination Shock and moved into a region called the **Heliosheath**. This is a region where the interstellar medium is mixing with the materials of the solar wind.

## Solar System Details

The solar system extends to a distance 50,000 times the distance from the Sun to the Earth. The top chart in Figure shows the entire solar system from the Sun to the end of the sun’s gravitational influence, the end of the **Oort Cloud**. The second chart shows the solar system from the Sun to the End of the **Scattered Disk** (0 to 2000 AU). The third chart shows the solar system from the Sun to the end of the **Kuiper Belt** (0 to 50 AU). The bottom chart shows the solar system from the Sun to Jupiter (0 to 5 AU).



**Note:** Eris, the dwarf planet, is located in the Scattered Disk.

**Note:** The Oort Cloud is located beyond the Heliopause. At 50,000 AU, the outer edge of the Oort Cloud is the limit of the sun’s gravitational influence.

## Component 38 – Solar System Formation

A theory of the formation of the solar system needs to explain all of the things that we see in the solar system today. It must also be able to explain all of the new star systems that we discover.

### What We See Today in the Solar System

**Individual Planets.** Our solar system has 8 distinct planets. They are spaced out throughout the solar system with the inner planets closer together and the outer planets more widely spaced.

**Planetary Rotations.** Most planets rotate counterclockwise when viewed from above the solar system as defined by Earth's North Pole. The theory must explain this as well as why some do not conform.

**Planetary Orbits.** All planets revolve around the Sun in a counterclockwise direction.

**Nearly Circular Orbits.** The orbits of the planets are nearly circular.

**Orbital Plane.** All of the planets and many of the moons orbit close to the same plane: the Ecliptic.

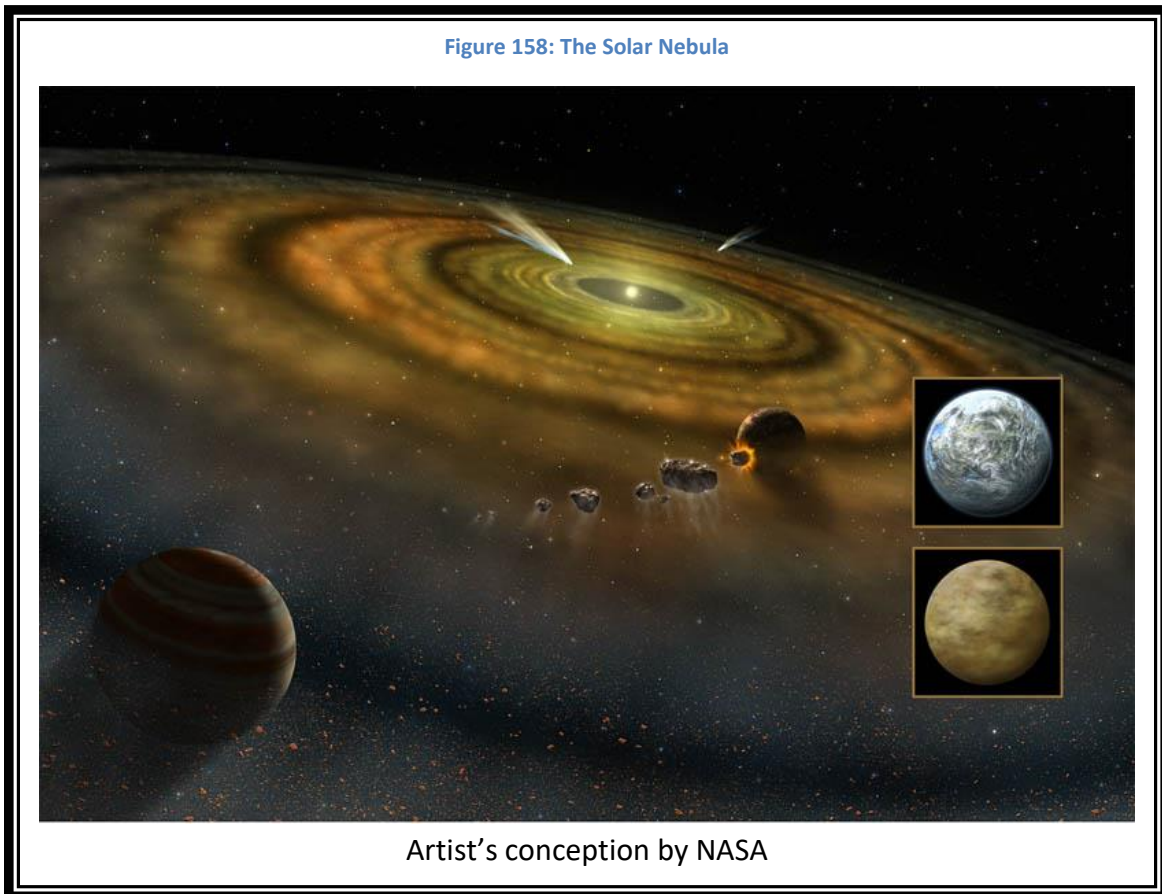
**Differentiation.** The solar system is heavily differentiated. We have rocky inner planets and gaseous outer planets. We have a region containing rocky objects called the Asteroid Belt. We also have a region of icy objects beyond the orbit of Neptune called the Kuiper Belt. Lastly, there is the spherical region of icy objects called the Oort Cloud.

### The Nebular Theory

First we need a theory that explains the general formation of the planets and the solar system. The theory widely accepted at this time is called the **Nebular Theory**. This theory states that initially there was a nebula of gas and dust, roughly one light-year in diameter. This nebula was disturbed by a shockwave from an outside source. It could have been a collision with another nebula, the formation of a star, or the explosion at the end of a star's life. This shockwave would cause some of the material to condense. As it condensed it would heat up and its rotation velocity would increase. A spinning sphere will flatten and become a disk. The center would form into a protostar and eventually the sun. The outer regions would form into planets. Astronomers can see similar disks that have formed around young stars. Conservation of Angular Momentum means that objects formed from the solar nebula would keep the angular momentum of the original nebula. This means that they should all rotate and revolve in the



same direction. In the case of our solar system, this direction is counterclockwise. This would also result in roughly circular orbits for the planets lying in the same orbital plane. The



### Condensation Theory

Small dust particles in the nebula act as condensation sites. Their small gravity attracts other particles. As more material is collected, the mass and gravity increase. The process of growing this way is called **Accretion**. The small objects are called **Planetesimals** and eventually some would become **Protoplanets**. As these protoplanets form they begin to attract each other. Collisions either result in mergers, creating larger objects, or they cause fragmentation which send out materials that combine with other protoplanets. Eventually these sweep out the solar system and create relative voids between the surviving planets.

### Gravitational Instability Theory

There is also a complementary theory that states that the outer planets formed from instabilities in the solar nebula. This **Gravitational Instability Theory** allows the outer planets to begin forming earlier. This could have occurred in as few as 1000 years. This would also allow them to attract the hydrogen and helium gas from the surrounding nebula before the

solar winds could blow it away. The major moons of the outer planets would have formed in the same way, as accretion disks around the outer planets.

### **Differentiation Within the Solar System**

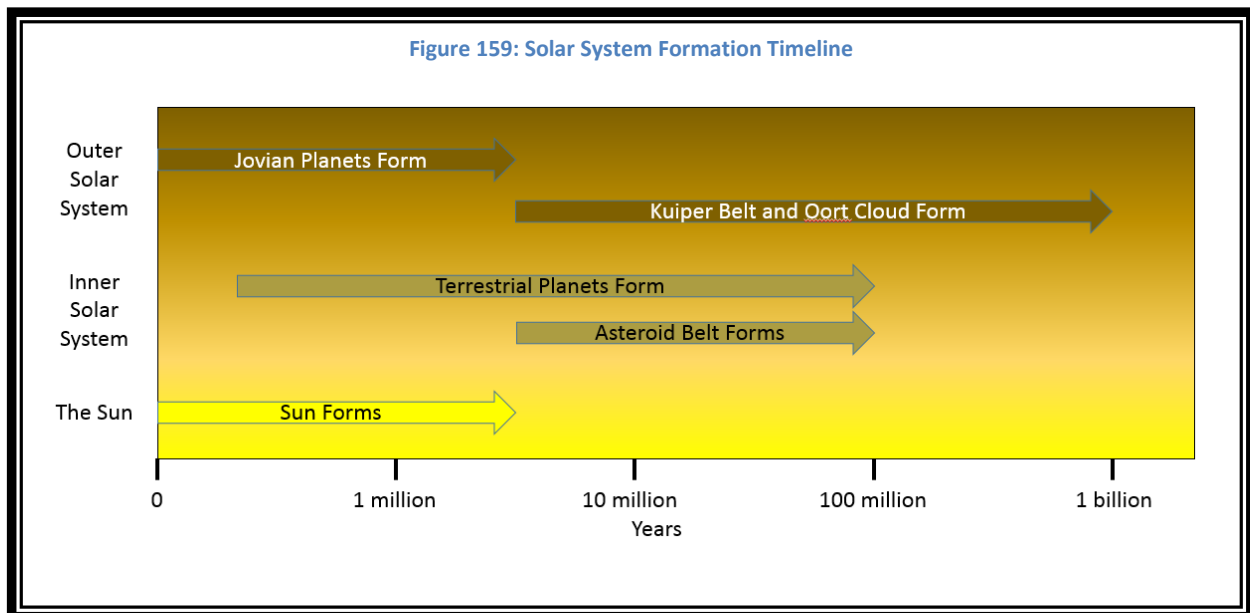
As you move outward from the Sun, the temperature decreases and different materials would begin to condense. Initially this would be metallic material (near Mercury's orbit) followed by rocky material (near Earth's orbit). Farther out water ice would form (beyond Jupiter's orbit), and then ammonia ice. The strength of the solar wind would also decrease as you move farther away from the Sun. As the materials in the solar nebula were dispersed or condensed into planets the temperature would drop significantly.

### **Giant Planet Migration Theory**

The giant planets, when they formed, would still be largely embedded in the solar nebula. As they orbited the Sun, they would run into materials in the nebula. This would have the effect of slowing down their motion and would cause them to spiral inward to their present orbits. Evidence that supports this theory is concentrations of gases in the atmosphere of Jupiter and Saturn that are too high if the planets formed in their current orbits.

### **Solar System Timeline**

Different amounts of time were required for the different components of the solar system to form. And each component had an ideal time to begin the process.

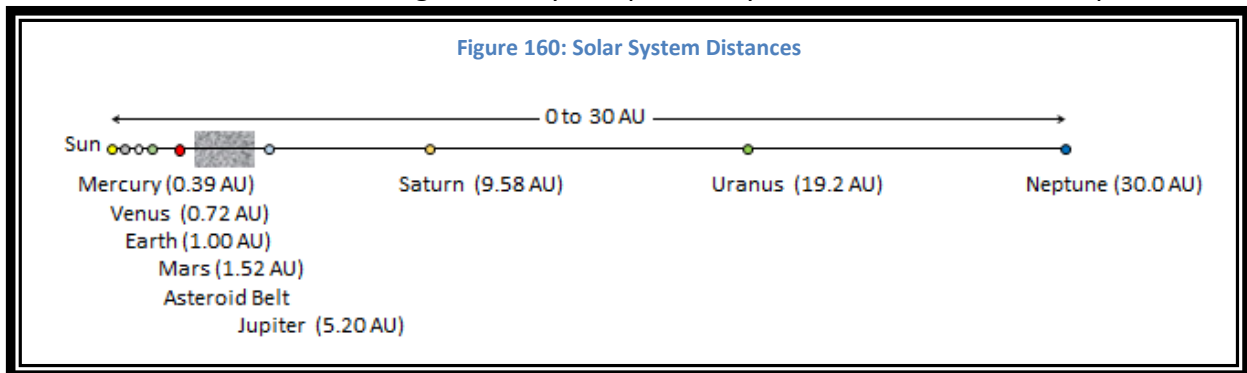


## Component 39 – Comparative Planetology

Humans have a need to compartmentalize the things they see. We need to compare and contrast objects to fully understand how they all fit into the big picture. One area where this is helpful is in the comparison of the planets. We will explore what they have in common and what characteristics are unique.

### The Scale of the Solar System

The solar system is a big place. We will focus our attention on the planets. In close to the Sun, where the Earth is located, things are fairly compact. As you move out to the outer planets,



*To remember these values, use this technique:*

- The Earth is 1 AU. This is the definition of the AU.
- Mercury is roughly  $1/3$  the distance from the Sun to the Earth:  $1/3$  AU.
- Venus is roughly  $2/3$  the distance from the Sun to the Earth:  $2/3$  AU.
- Mars is at 1.5 AU.
- Jupiter is at 5 AU.
- The other three planets, Saturn, Uranus, and Neptune, are at 10, 20, and 30 AU.

there is a lot of empty space. As Figure shows, all of the planets from Mercury to Jupiter lie within the first  $1/6^{\text{th}}$  of the overall distance.

### **Planetary Pecking Order**

Another useful way to think about the planets is to think about them by comparing their sizes. Some are quite large, some are quite small.

### **Planetary Uniquenesses**

Each planet has features which make it unique in the solar System. This is also a helpful way to remember details about the planets.

- Mercury
  - Most eccentric (non-circular) orbit of the planets.
  - Smallest planet and closest to the sun.
- Venus
  - Hottest planet
  - Most similar to Earth in size and composition
  - Very white due to thick cloud cover
  - No details on surface of clouds
- Earth
  - Only planet known to have life
  - Only planet with lots of oxygen in its atmosphere
  - Only planet with constant liquid water on its surface
  - Only planet on which humans have walked
- Mars
  - Largest volcano in the solar system: Olympus Mons
  - Largest canyon in the solar system: Valles Marineris
  - The red planet
- Jupiter
  - The largest planet
  - Distinct bands on surface of clouds
  - Strongest magnetic field: reaches out past the orbit of Saturn
- Saturn
  - The rings!
  - The most known moons
  - The yellow planet

- Uranus
  - Blue-green planet
  - Magnetic field is off center and far from the rotation axis
  - No details on surface of planet
- Neptune
  - Blue planet
  - Magnetic field is off center and far from the rotation axis
  - Farthest from the sun

### **Terrestrial vs. Jovian**

There are two obvious groups of planets in the solar system: the Earth-like planets and the Jupiter-like planets. The Earth-like planets are called Terrestrial Planets. The Jupiter-like planets are called Jovian Planets. They have very different characteristics.

#### **Terrestrial Planets**

- **Mercury, Venus, Earth, Mars**
- Close to the sun
- Close to the neighbors
- Weak or no magnetic fields
- Smaller
- Few moons
- No rings
- Rocky

#### **Jovian Planets**

- **Jupiter, Saturn, Uranus, Neptune**
- Further from the sun
- Neighbors are far apart
- Strong magnetic fields
- Larger
- Many Moons
- Rings
- Gaseous
- Most emit more energy than they receive from the Sun

### ***Terrestrial Planets***

*Mercury*

*Venus*

*Earth*

*Mars*

### ***Jovian Planets***

*Jupiter*

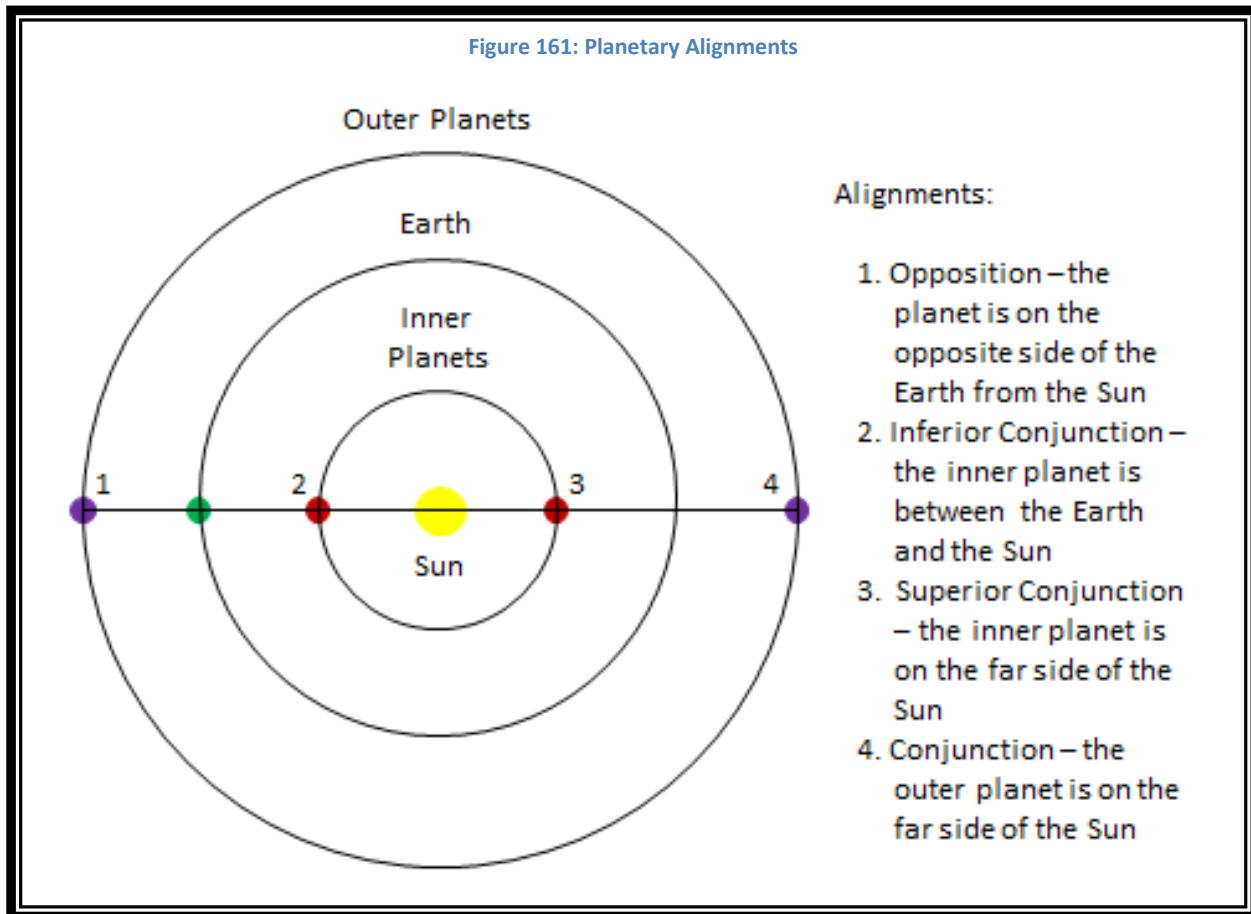
*Saturn*

*Uranus*

*Neptune*

## Planetary Alignments

As planets orbit the Sun, there are times when the Sun, the Earth and planets form a line in space. This is called an Alignment. When the Sun and the planets are in the sky together, on the same side of the Earth it is called a Conjunction. When the planet and the Sun are on opposite sides of the Earth it is called an Opposition. These different alignments are shown in Figure .: **Opposition, Inferior Conjunction, Superior Conjunction, and Conjunction.**



## Component 40 – Solar System Exploration

We can do much by studying the planets from Earth, but the closer you get, the more you know. Getting close to a planet is the first step. If you can spend more time there, then you can learn even more. If you can touch the planet, then whole new frontiers are available to you. And if humans can touch it personally, then you have the ability to learn almost everything about the object.

The first objective is to reach space. In 1957, the Soviet Union launched **Sputnik 1**. This was the first man-made object to attain Earth orbit. It was in orbit for 92 days. To hear the sounds of Sputnik 1 go to the website:

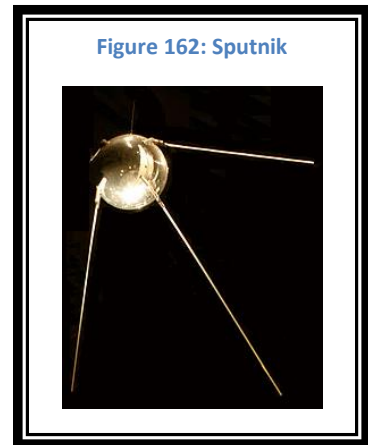
<https://www.youtube.com/watch?v=r-bQEiklsK8>

### Types of Exploration

Exploration of the solar system is done in stages. Each stage is more difficult to accomplish but yields much more information. Sometimes stages are combined.

Stages of Solar System Exploration (from easiest to most difficult):

- **Fly-By:** This is the simplest mission from a trajectory perspective. The intent is to get the spacecraft close to the planet. It provides astronomers with detailed information on the gravity and mass of the planet as well as returns some close up pictures of the planet and some of its moons. It will indicate if there is an atmosphere around the planet, its composition, and whether there are rings.
- **Orbital:** To accomplish a stable orbit requires more accurate positioning of the spacecraft. But once in orbit it is possible to map the entire planet's surface in high resolution. You can also map the planet spectroscopically to gain information on the composition of its crust.
- **Lander:** Some landers are crash landers. On the way through the atmosphere the spacecraft can develop a profile of the structure of the atmosphere. The spacecraft then hits the planet hard enough to eject material from the crust. This gives astronomers the opportunity to study below the surface. This will often provide the opportunity to look for water under the surface. More science can be done with a soft landing. It requires more preparation to provide a spacecraft that can control its descent to the planet's surface. This provides a means to take samples of the surface and to



study their composition in detail using on-board instrumentation. The lander may also dig into the surface searching for the presence of frozen subsurface water.

- **Sample Return:** This mission increases the complexity again. Not only must the lander safely descend to the planet's surface, but it must also have the ability to do a lift off and return flight to Earth. To study the material on the surface of a planet in more detail it is necessary to bring some of it back to Earth to study in laboratories by geologists.
- **Rover:** If you can provide a lander that can move to additional areas of the surface of a planet, then you can search for signs of water and perhaps signs of life. It lets the equipment take samples from different places and gives scientists the choice of which areas to pursue.
- **Human Visit:** The most difficult missions are those that involve human participation. Not only do you have all of the previously mentioned challenges, but you also need to provide life support for the people. But this form of exploration also provides the greatest rewards. Humans will notice things that robotic missions will miss. Based on those observations, it is possible to modify missions to investigate interesting areas.

*The Moon and the Earth  
are the only two places  
that humans have walked*

## The Moon

The easiest member of the solar system to visit beyond the Earth is the moon. It is relatively nearby. The Moon is the only place that humans have visited beyond the Earth.

Some accomplishments in investigating the moon include:

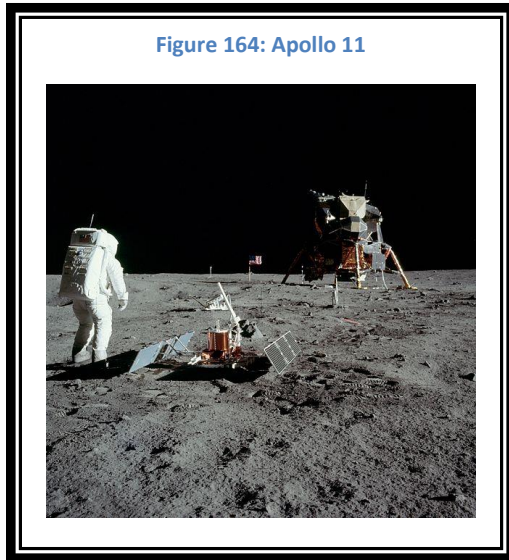
- 1959 – Pioneer 4 (United States). Fly-By mission that was at too great a distance to return useful information from the on-board instrumentation. This was the first mission to successfully leave Earth orbit.
- 1959 – Luna 2 (Soviet Union). This mission was a crash landing. This was the first mission to reach the moon's surface.
- 1959 – Luna 3 (Soviet Union). This mission was the first spacecraft to orbit the moon. It was the first time that we could see the far side of the moon.





## Astronomy for Mere Mortals – An Introductory Astronomy Text

- 1966 – Luna 9 (Soviet Union). This spacecraft was the first to have a controlled descent and soft landing on the Moon
- 1968 – **Apollo 8** (United States). This was the first trip to the Moon by humans. It was only an orbiter. There was no landing.



- 1969 – Apollo 11 (United States). This is the first time that humans have walked on any object other than the Earth when Neil Armstrong was the first person to walk on the Moon. This was the first sample return mission: 47.5 pounds of rocks were brought back to Earth.
- 1970 – Luna 17 (Soviet Union). The first rover was deployed to the Moon.
- 1971 – Apollo 15 (United States). This was the first time that humans used a vehicle on the Moon.
- 1972 – Apollo 17 (United States). This was the last time that humans walked on the Moon. A total of 12 people walked on the Moon.

### Mars

Missions have been sent to all of the planets in the solar system. We will focus on some of the more significant explorations. These were major accomplishments at Mars:

- 1964 – Mariner 4 (United States). This was the first successful fly-by mission.
- 1971 – Mariner 9 (United States). This was the first successful orbiter.
- 1975 – Viking 1 (United States). This was a successful soft landing.
- 1996 – Sojourner (United States). This was the first rover on Mars. It operated for 84 days.

**Note:** There have been many failed missions to Mars. There are people with theories that there is a mysterious reason behind these failures. The fact is that space travel is hard. The more you try to accomplish the more you have failures. Of the Moon missions only 66 of 179 have been successful. At Mars, 26 of 54 missions have been successful.

### Other Objects in the Solar System

Missions have been sent to other members of the solar system family. The history of different objects can shed light on different aspects of the origin and history of the solar system.

**Solar Wind.** In 2004, the Genesis spacecraft returned to earth with samples of material in the solar wind.

**Comets.** In 2005 the Deep Impact spacecraft (United States) launched an impactor that crashed into comet Tempel 1. The plume of material enabled astronomers to study the composition of a comet's nucleus. The Giotto and Stardust missions were previous fly-bys of comets. Giotto was launched by Europe and flew by comet Halley in 1986. The Stardust mission was launched in 1999 and flew by comet Wild 2. It collected samples which it returned to Earth in 2006.

**Asteroids.** NEAR-Shoemaker (United States) was a mission to an asteroid. The spacecraft orbited asteroid Eros and culminated in a landing on the asteroid.

### Leaving the Solar System

It takes a very long time to get there, even at the great speeds with which spacecraft travel, but there are places to visit and things to see outside of our solar system as well. At this time, humans have sent 5 spacecraft outside of the solar system. These were fly-bys of distant planets and provided the opportunity to send a message to anybody that might be out there.

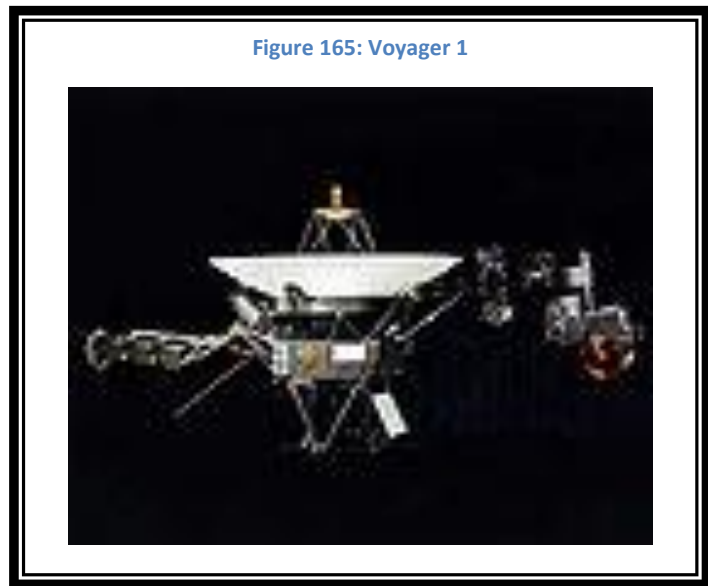


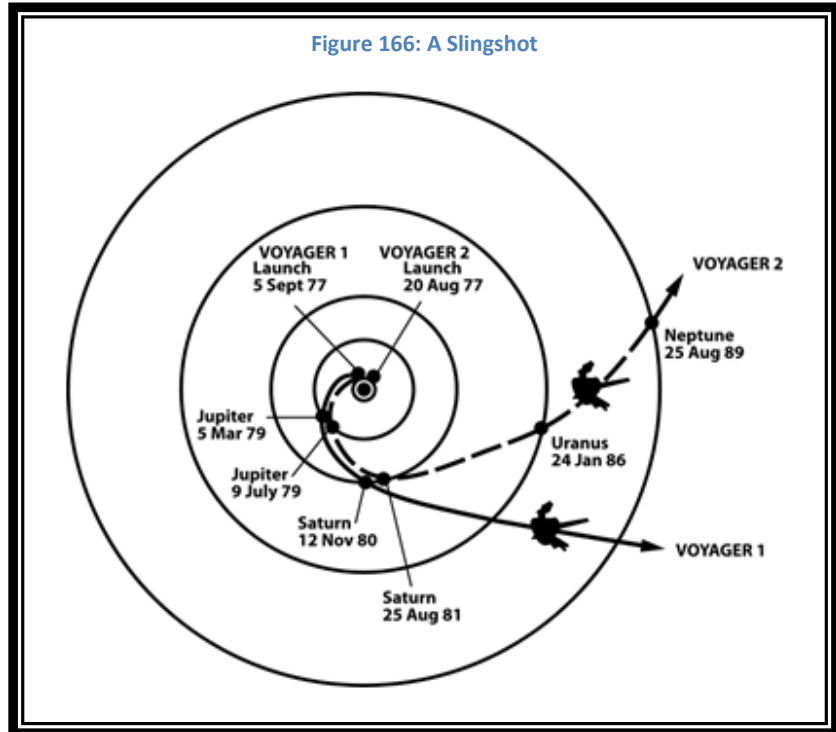
Figure 165: Voyager 1

The interstellar travelers from Earth are currently:

- **Voyager 1**                      1977                      3.6 AU/yr.                      132.76 AU (2013)
  - Jupiter, Saturn and beyond
- **Voyager 2**                      1977                      3.2 AU/yr.                      102.6 AU (2013)
  - Jupiter, Saturn, Uranus, Neptune and beyond
- **Pioneer 10**                      1972                      2.39 AU/yr.                      110 AU (2014)
  - Jupiter
- **Pioneer 11**                      1973                      2.22 AU/yr.                      89 AU (2014)
  - Jupiter, Saturn
- **New Horizons**                      2006                      4.1 AU/yr.                      39 AU (2015)
  - Jupiter, Saturn, Pluto

## The Slingshot

To develop enough speed to escape from the solar system or to reach the outer planets requires a lot of fuel. The more fuel you need the heavier your spacecraft will become. To overcome this problem, scientists have developed a technique called the **Slingshot**. When a spacecraft executes a slingshot, it flies in close to a massive body like a planet. It then uses the planet's gravity to gain speed and to change its direction.



## Living in Space

Most space missions that are manned are relatively short. Even trips to the Moon have been short. But to explore beyond the Moon, humans will have to live in space for extended periods of time measured in many years.

This is a list of space stations that have been used:

- Salyut 1 (Soviet Union)      1971    crew of 3, occupied for 24 days
- Skylab (United States)      1973    crew of 3, occupied for 171 days (3 crews)
- MIR (Soviet Union)          1986    crew of 3, occupied for 4,592 days (multiple crews, longest stay was 438 days)
- **International Space Station**    1998    crews of 3 to 6, occupied for 7,365 days as of December 31, 2020 (multiple crews, longest stay was 437 days)
- Tiangong 1                      2011    2,376 days in orbit, 2 crews of 3 (occupied for 13 days each, not continuous)
- Tiangong 2                      2016    still in orbit, unmanned, only 1 crew of 2 (manned for 29 days)

Figure 167a: Salyut 1 and MIR

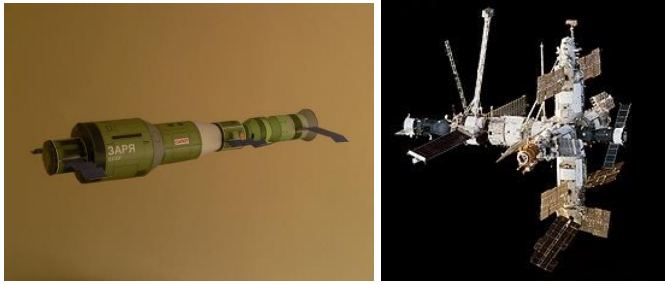


Photo by Godai

Figure 167b: Skylab



Figure 167c: International Space Station



Figure 167d: Tiangong



## Component 41 – The Earth's Data

### The Earth

- Mass  $5.97 \times 10^{24}$  kg
- Equatorial Radius 6378 km
- Surface Gravity  $9.8 \text{ m/s}^2$
- Escape Velocity 11.2 km/s
- Number of Natural Moons 1

### The Earth's Orbit

- Semi-Major Axis  $149.6 \times 10^6$  km
- Sidereal Orbital Period 365.256 days
- Tropical Orbit Period 365.242 days
- Perihelion  $147.09 \times 10^6$  km
- Aphelion  $152.1 \times 10^6$  km
- Sidereal Day 23.93 hours
- Solar Day 24.0 hours
- Axial Tilt  $23.44^\circ$

### Magnetosphere

- Field Strength 0.3076 gauss-Rh<sup>3</sup>
- Tilt to Axis  $10^\circ$

### Atmosphere

- Average Temperature 288 K
- Composition:
  - **Nitrogen** 78.07 %
  - **Oxygen** 20.95 %
  - Water 1.0 %
  - Argon 9340 ppm
  - Carbon Dioxide 400 ppm
  - Neon 18.2 ppm
  - Helium 5.24 ppm
  - Methane 1.7 ppm
  - Krypton 1.14 ppm

**Note:** Water percentage is approximate and variable.

**Note:** ppm stands for parts per million.

For the latest information on technical data for the Earth, go to NASA's website:

<http://nssdc.gsfc.nasa.gov/planetary/factsheet/earthfact.html>

## Component 42 – Earth’s Structure

To understand the structure of planets we have not visited, it helps to understand the planet on which we live; the planet where we can more easily do experiments. The Earth has internal structure. Understanding how the Earth is structured tells us information about the formation of the Earth and its early history.

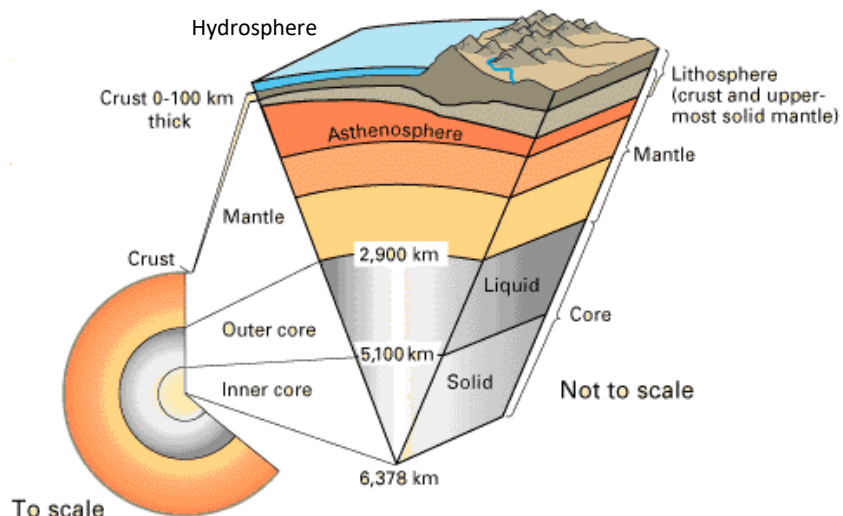
### The Structure

Table 10: The Layers of the Earth’s Structure

Layer	Sub-Layer	Thickness (maximum)	Comment
Core	Inner Core	1278 km	Solid
	Outer Core	2200 km	Liquid
Mantle	Lower Mantle	2250 km	
	Upper Mantle	300 km	Asthenosphere
		250 km	
		90 km	The Lithosphere is the Crust and the uppermost layer of the Mantle
Crust		100 km	
Hydrosphere		20 km	This is the liquid water layer

The Earth is a ball, but it has layers. These layers formed early in Earth’s history when the planet was molten. The heavy materials sank to the center of the Earth. This is a process known as **Differentiation**. Figure identifies those levels and their thicknesses.

Figure 168: The Earth’s Internal Structure



Drawing by USGS

The **Core** consists of two sublayers, the **Inner Core** and **Outer Core**. The Inner Core is solid and is composed of iron and heavy metals. The Outer Core is also composed of iron and heavy metals but it is liquid.

The thickest layer in the Earth's Structure is the **Mantle**. It has four sublayers. The Mantle consists mostly of silicate rocks that are semi-solid. The upper layer of the Mantle is composed of rigid rocks. This layer combined with the Crust is known as the Lithosphere. The upper layer of the Mantle has convection cells. These are places where the material is in motion similar to a pot of boiling water. As the material moves it causes tectonic plate movement of the crust. Moving inward, the next layer of the Mantle is composed of weak rock. The rock in this layer is partially molten. The next layer is composed of very strong rock. These two layers are known as the Asthenosphere. The lowest layer of the Mantle is called the Lower Mantle. It is composed of very rigid rock.

The next layer of the Earth's structure is the **Crust**. This is a rigid and rocky layer.

The top layer of the Earth's internal structure is the **Hydrosphere**. This is the layer of liquid water that exists on the Earth's surface. This is primarily the Earth's oceans. The Crust is thinnest under the oceans.

*Key Layers of the Earth's Structure:*

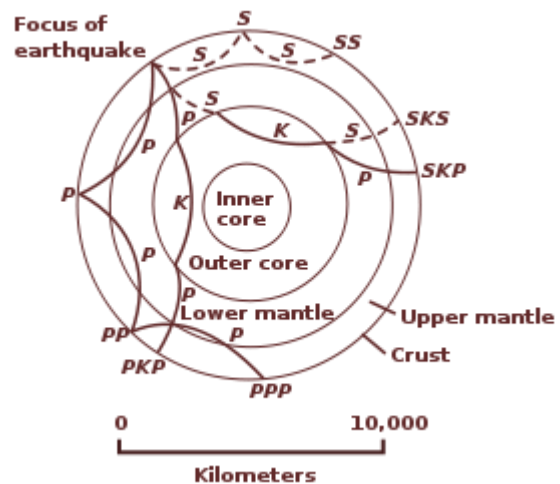
- *Hydrosphere*
- *Crust*
- *Mantle*
- *Outer Core*
- *Inner Core*

*Seismic Waves tell us about the internal structure of the Earth*

**Seismic Waves**

**Seismic waves**, from natural sources such as earthquakes, or from man-made sources such as explosions, travel through the Earth's interior. The behavior of these waves tells us the location of the boundaries between layers. As the material changes in composition or in state (solid or liquid) the waves reflect

Figure 169: Seismic Waves



Drawing by USGS

differently. Figure shows how these waves react to the layers within the Earth.

There are two kinds of waves shown in the drawing: Primary: “P” and Secondary: “S”. There are also surface waves that travel along the crust. Waves that travel through the Core are designated with a “K”.



## Component 43 – Earth's Atmosphere

### Structure and Temperature

The Earth's atmosphere has 5 levels:

- **Troposphere** – This is the level closest to the Earth's surface. Almost all weather occurs in this level. This is also the level in which most aircraft fly. It extends from the Earth's surface to 12 km. As the altitude increases the temperature drops steadily.
- **Stratosphere** – This is the next level above the Troposphere. This is where the **Ozone Layer** is. It extends from 12 to 50 km. As the altitude increases, the temperature also increases.
- **Mesosphere** – This is the level of the atmosphere where the atoms are dense enough to cause friction with incoming meteors. It extends from 50 to 85 km. As the altitude increases the temperature drops steadily again.
- **Thermosphere** – This is the level of the atmosphere that is the upper limit of where the atoms in the air behave like an atmosphere. Satellites in low Earth orbit, including the International Space Station, are in this region. It extends from 85 to 600 km. Temperatures in this level rise as the altitude rises up to about 200 km. Above that altitude, the temperature remains constant at approximately 825 K
- **Exosphere** – This is the outmost layer of the atmosphere. This is where the materials of the atmosphere merge with the materials of interplanetary space. Gases in this level are mostly hydrogen with some helium, carbon dioxide, and atomic oxygen. It extends from 600 to 10,000 km.

### *Key Layers of the Earth's Atmosphere:*

- *Exosphere*
- *Thermosphere*
- *Mesosphere*
- *Stratosphere*
- *Troposphere*

*The Ozone Layer is in the Stratosphere and protects us from Ultraviolet Light.*

### The Ionosphere

The ionosphere is a part of the atmosphere where solar radiation ionizes atoms in the atmosphere. It extends from 60 to 1000 km. It encompasses the upper level of the mesosphere, the thermosphere, and into the exosphere.

## Cycles

**Convection.** The air in the Troposphere is in constant motion. Warm air rises and cool air falls. Land and water absorb heat during the day and radiate it back at night. Moist air behaves differently than dry air. These movements are responsible for the winds.

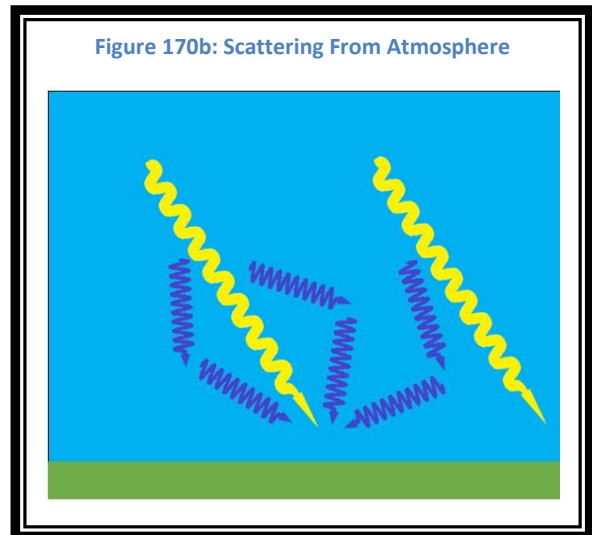
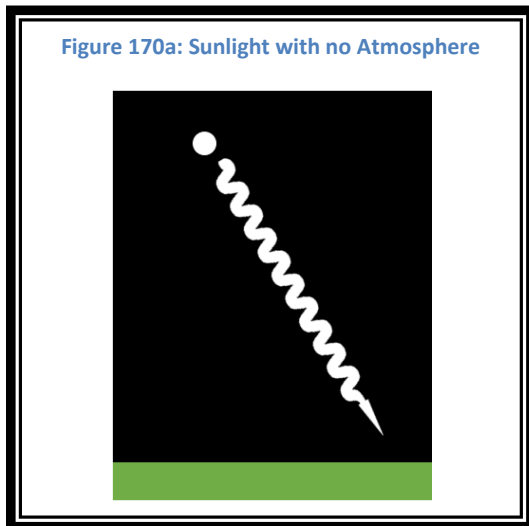
**The Water Cycle.** Water on the Earth's surface and in the Earth's atmosphere is constantly being recycled. Water in the oceans and lakes evaporates and becomes water vapor in the atmosphere. This forms into clouds and returns water to the Earth in the form of rain or snow. The snow melts and this water with the rain returns to the oceans through rivers and streams.

## Rayleigh Scattering

Molecules and dust in the atmosphere scatter light. As the frequency increases, the scattering also increases.

**The Sky is Blue.** Sunlight enters the Earth's atmosphere where dust and molecules tend to scatter the bluer light. In the direction of the sun, we see the non-scattered light which is missing the blue components and so appears yellowish. In other directions we see blue light that is scattered by the dust and molecules from other light (see Figure ).

**The Sun is Yellow.** This is why the Sun appears to be yellow. With the blue light missing, the combination of the remaining wavelengths appears yellow.



**The Red Sun, Moon and Sky.** The Moon and Sun, when they are near the horizon, are often red. And often the clouds near the horizon will appear red. This is due to the greater amount of atmosphere through which the light must travel to reach the observer. The thicker atmosphere will scatter more light, resulting in mostly red light reaching the observer.

### **Greenhouse Effect**

A planet's atmosphere receives energy from the Sun. Some of the sunlight is reflected back into space by clouds. Some of the light will reach the Earth and will heat the land and water. The land and water will then reradiate this heat back towards space as infrared radiation. Certain gases present in the Earth's atmosphere will trap heat trying to leave the Earth. This effect is what makes our day to night temperature changes reasonable and makes the Earth a good place to live. This is called the Greenhouse Effect.

Excessive amounts of water vapor and carbon dioxide in the atmosphere make the atmosphere retain more heat. This is called a Runaway Greenhouse Effect. This will raise the average temperature on Earth and will cause changes to life on Earth.

The balance of energy that the Earth receives and the amount it radiates into space is called the Earth's Energy Budget. Figure 172 represents this budget and how the energy is distributed.

Some of the results of this Greenhouse Effect are:

- **Weather extremes:** There will be more time when the weather will vary from the historical norm. Times will be hotter, and times will actually be colder. The swings will become more severe. We will have more droughts and also more rain from severe thunderstorms, hurricanes and tornados. Deserts will enlarge and extend further from the equator.
- **Glaciers will melt:** As the average temperature rises, the glaciers will melt and recede. This additional water will change the salinity in parts of the oceans and will cause the ocean levels to rise causing major coastal flooding.
- **Vegetation will change:** As temperatures rise, vegetation will need to adjust. Some plants will move farther from the equator and to higher latitudes. There will be massive crop failures.

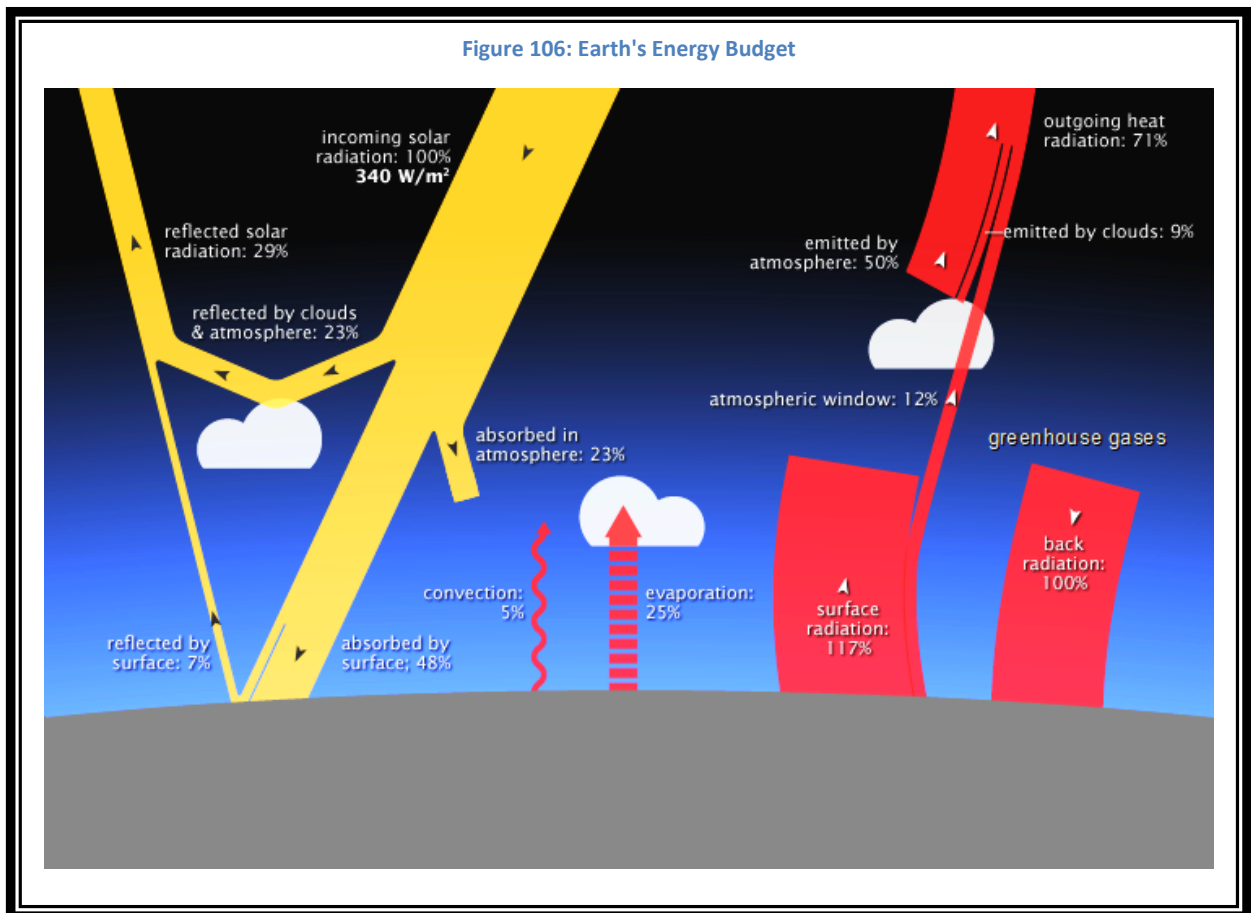


- **Insect pests:** As the vegetation is forced to move toward the poles, the insects that thrive in those climates will also move. This means that areas that have not have widespread disease by insects such as mosquitos will become infested. This will bring tropical diseases to areas not prepared to deal with the new diseases.

**Global Warming.** The change in the average temperate of the Earth is known as Global Warming. There are natural events that impact global warming, such as volcanos, but human activities also have an impact.

### The Earth's Atmosphere

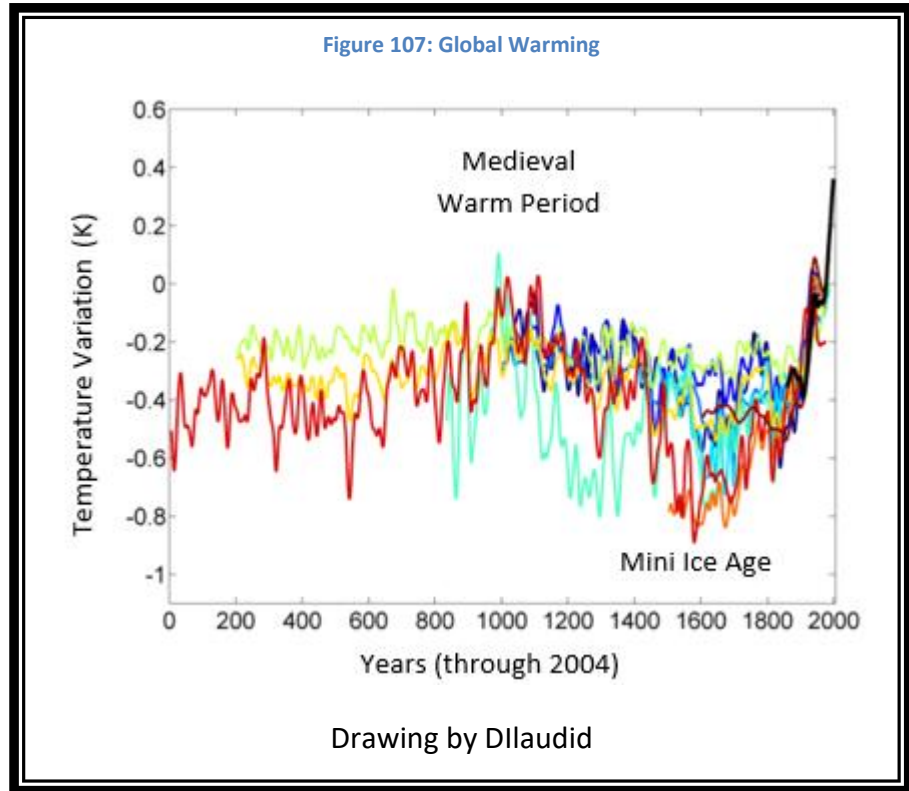
A planet's atmosphere changes over time. The Earth has had **three** different atmospheres since the planet formed. The current atmosphere is ideal for life that we have on Earth at this time. Each atmosphere has played a role in reaching where we are today.



**Primary Atmosphere.**

Initially the atmosphere would be composed of those elements that were abundant and available when the Earth formed. This would include large amounts of hydrogen and helium as well as water, ammonia, and methane. The hydrogen and helium would have escaped the Earth during the first 500,000 years. The Earth's gravity is not strong enough to prevent these

light gases in the atmosphere from reaching escape velocity and reaching interplanetary space.



**Secondary Atmosphere.** As the earth was cooling, volcanos expelled large amounts of new gases into the atmosphere. These would include water, carbon dioxide, nitrogen, ammonia, methane, sulfur dioxide, and nitric oxide. Ultraviolet radiation from the Sun, with no protective Ozone Layer, would penetrate into the atmosphere and split some of the lighter gases into their individual atoms. Hydrogen would escape to space and would leave behind nitrogen and oxygen. As the temperature fell, the water would condense to form liquid water on the surface in the form of lakes and oceans. The free oxygen would react with materials in the rocks and no longer be a gas in the atmosphere.

**Tertiary Atmosphere.** Approximately 3.5 billion years ago, life began to emerge in the oceans on planet Earth. These simple organisms would convert gases dissolved in the oceans into free oxygen. Some of the oxygen formed Ozone in the Stratosphere and created the Ozone Layer. As life flourished, more and more oxygen filled the atmosphere. Although much was still being absorbed into the rocks, there was excess. Life continued to evolve, moved onto land, and animals began to breathe the oxygen. The tertiary atmosphere consisted of nitrogen, oxygen, and argon with trace amounts of other gases.

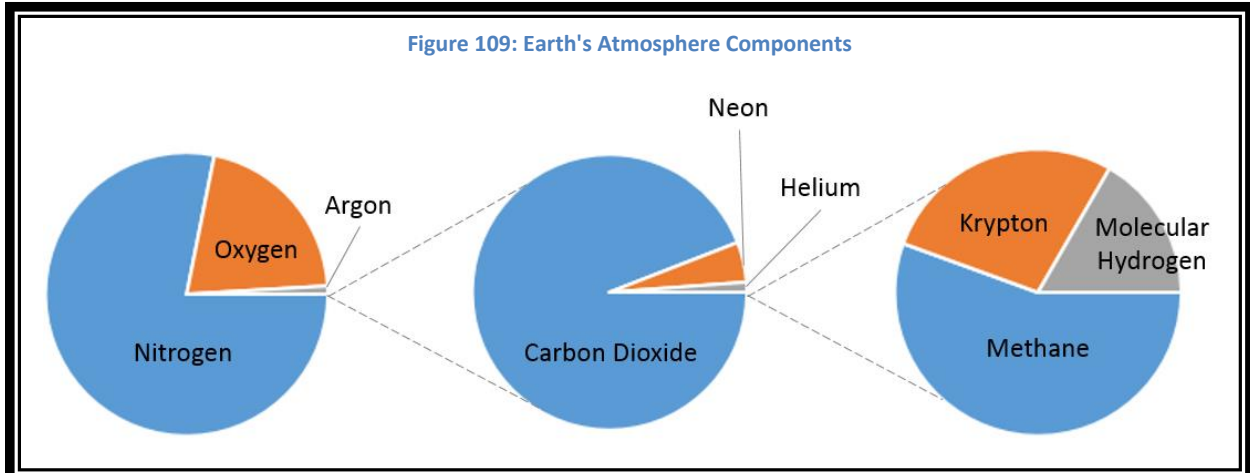
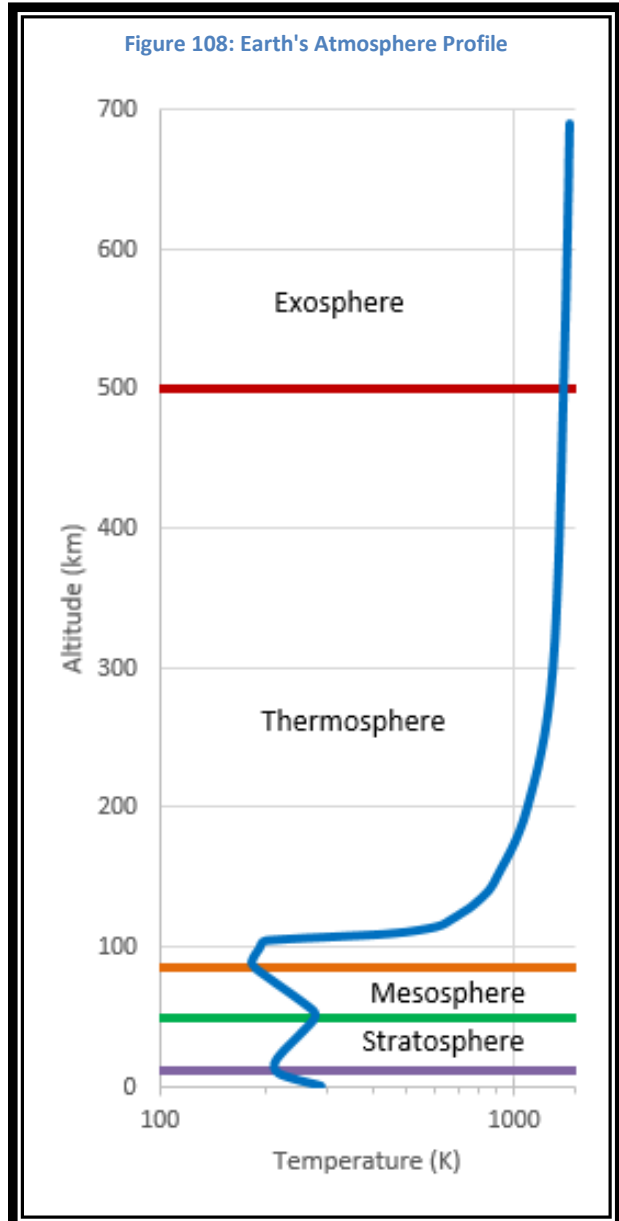


Table 11: Earth's Atmosphere Components

Nitrogen	78.1 %
Oxygen	20.9 %
Argon	0.93 %
Carbon Dioxide	0.04 %
Neon	0.002 %
Helium	0.0005 %
Methane	0.0002 %
Krypton	0.0001 %
Molecular Hydrogen	0.00006 %



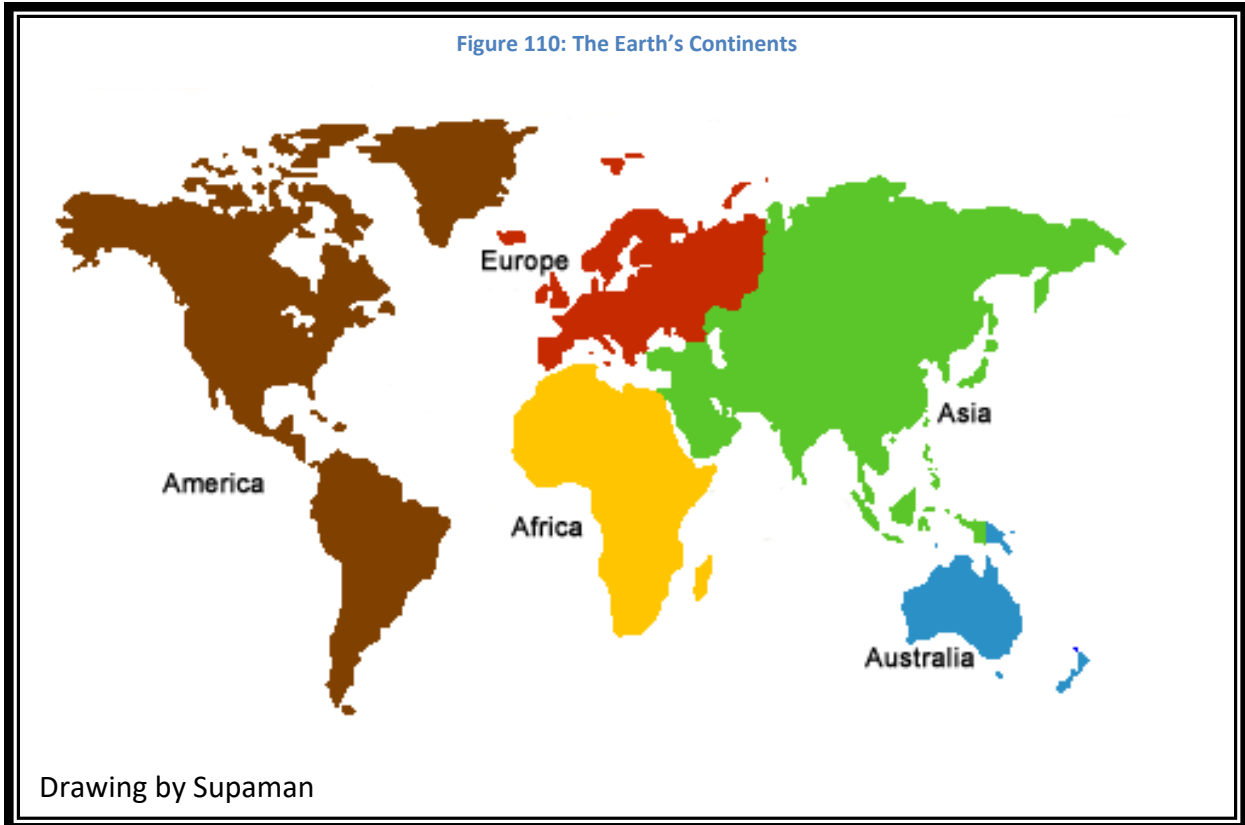
Earth's current atmosphere has well defined layers. The temperature changes significantly at each boundary. Figure 174 indicates how the temperatures change in each level. Below the violet line is the Troposphere.

### Ozone Layer

There is a layer of **Ozone** between 12 km and 50 km in the Stratosphere. This layer protects the surface of the Earth from ultraviolet radiation. 90% of all of the Ozone in the Earth's atmosphere is in this **Ozone Layer**.

## Component 44 – Earth’s Surface

The Earth’s surface is split between land and water. The land is the Continents and the water is the Oceans. At this time the Earth has 7 continents: **North America, South America, Africa, Europe, Asia, Australia, and Antarctica.**



### Plate Tectonics

The surface of planets also changes over time. One force that shapes the Earth’s surface is **Plate Tectonics**. The surface of the Earth is in motion. This motion is caused by convection cells in the Mantle (see Figure 177). This results in the Earth’s Crust being sectioned into Tectonic Plates. The current set of Tectonic Plates is shown in Figure 179.

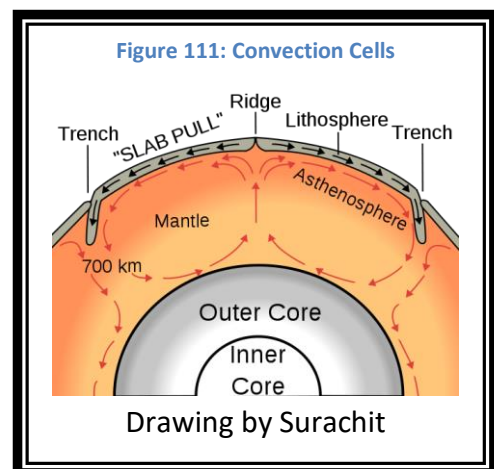
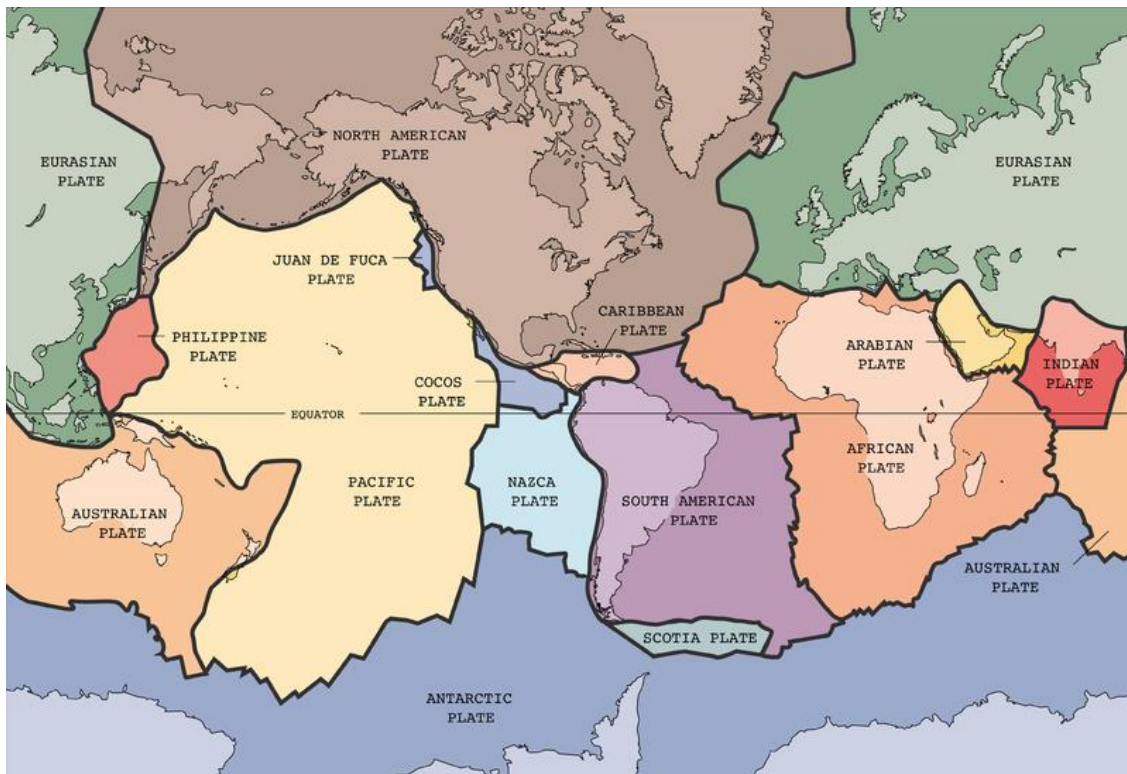


Figure 113: Tectonic Plates



Drawing by USGS

This motion is responsible for the current position of the continents on the Earth's surface. Over time these plates have moved and changed the orientation of these continents. Tracing this motion backwards in time, it indicates that 300 million years ago there was a single super continent called **Pangea** (see Figure 178).

This cycle of creating supercontinents is 300 to 500 million years long. There is evidence that indicates that there has been a series of these supercontinents in Earth's history.

The current phase of Plate Tectonics is responsible for some of the surface features that are evident in the Earth's Crust.

Figure 112: Pangea



Drawing by Kieff.



**Mountains.** Where plates are forced together the crust buckles and forms high mountains. This is evident in the Himalayan Mountains where the Indian Plate is pushing against the Eurasian Plate (see Figure 180).

**Ridges.** Where the plates are pulling apart, molten rock from the mantle is pushed up and forms Ridges to fill the gaps. This is evident by the Mid-Oceanic Ridges. Figure 183 is an image of a Black Smoker along the mid-Atlantic Ridge.

**Faults.** Faults form where plates are colliding and there is a sideways motion. This is evident in the San Andreas Fault that slices through California where the Pacific Plate meets the North

American Plate (see Figure 184).

**Volcanoes.** Volcanoes are caused by weak spots in the Earth's Crust where molten lava is able to push its way to the surface, as seen in the Hawaiian Islands and the volcanoes

found there. But they are also created when one plate is forced under another plate. This is called Subduction (see Figure 185). This is evident where the African Plate is pushing under the Eurasian Plate and has formed Mount Etna in Italy.

Figure 114: Mount Everest



Photo by Carsten.nebel

Figure 117: Mid-Atlantic Ridge

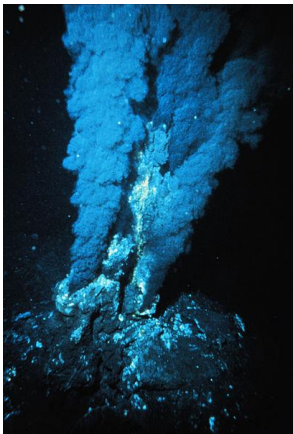


Photo by NOAA

Figure 116: Erosion by Wind



Photo by Jrmichae

Figure 115: Erosion by Water



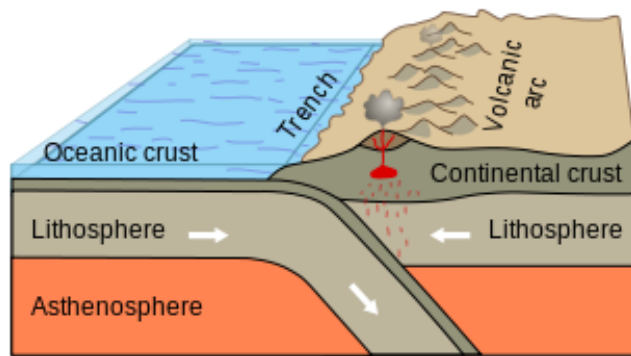
Photo by Лобачев Владимир

Figure 118: San Andeas Fault



Photo by USGS

Figure 119: Subduction



Drawing by Booyabazooka

Figure 120: Mount Etna



### **Erosion**

The surface of the Earth's Crust is also continually being changed by Erosion. Erosion is the gradual wearing-away of surface features. It is caused by the wind blowing sand and water flowing. This activity counteracts the building activities caused by Plate Tectonics.

## Component 45 – Earth’s Magnetosphere

Any planet with a magnetic field will have a **Magnetosphere**. This is the magnetic field extended out into space around the planet.

### The Magnetosphere

The Earth’s Magnetosphere (Figure 187) is flattened on the edge that is on the side of the incoming solar wind. It is extended outward on the opposite side into the **Magnetotail**.

### The Effect of the Magnetosphere

**Charged particles (Cosmic Rays)** approaching the Earth are trapped by this magnetic field. This has the effect of protecting the surface of the Earth, and things living there from the charged particles in the solar wind.

The regions where the charged particles are captured are called the **Van Allen Radiation Belts** (see Figure 188).

These charged particles spiral around the magnetic field lines and travel towards the Earth’s north and south magnetic poles. As the particles enter the Earth’s atmosphere they radiate light as the **Aurorae**. This radiation is caused by electrons jumping to higher energy states and is emitted as they drop to lower states.

Figure 121: The Earth’s Magnetosphere

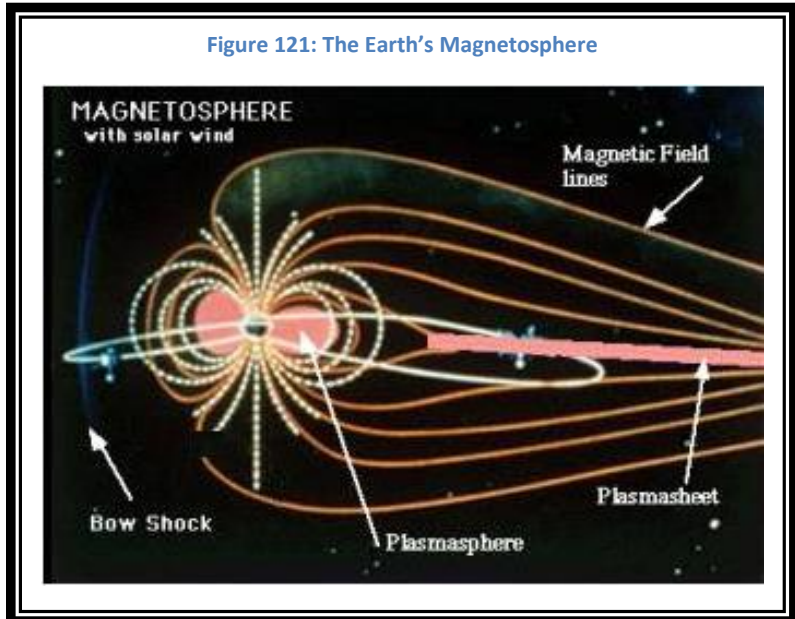
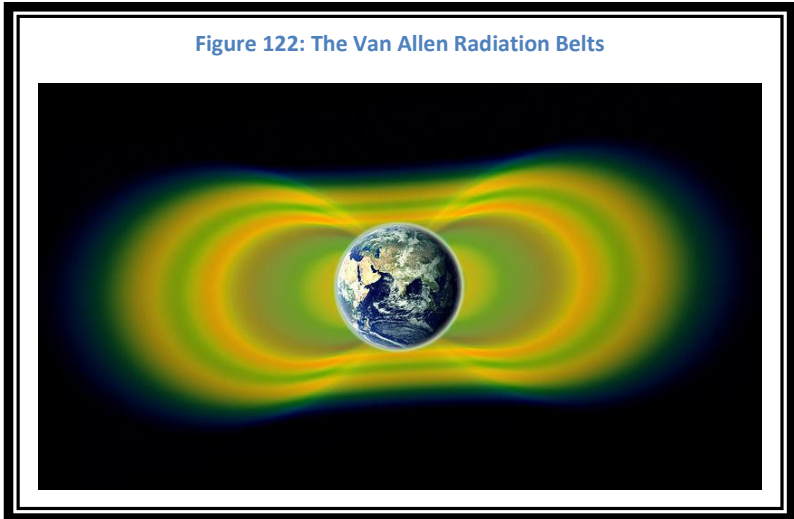


Figure 122: The Van Allen Radiation Belts



The most common aurorae are green. As the intensity increases the red components become brighter and more apparent. These colors can mix with blue components to yield aurorae of many different colors.

As the quantity of incoming particles increases, the Aurorae are visible at lower latitudes (see Figure 191).

Collisions of charged particles with the oxygen atoms in the atmosphere cause

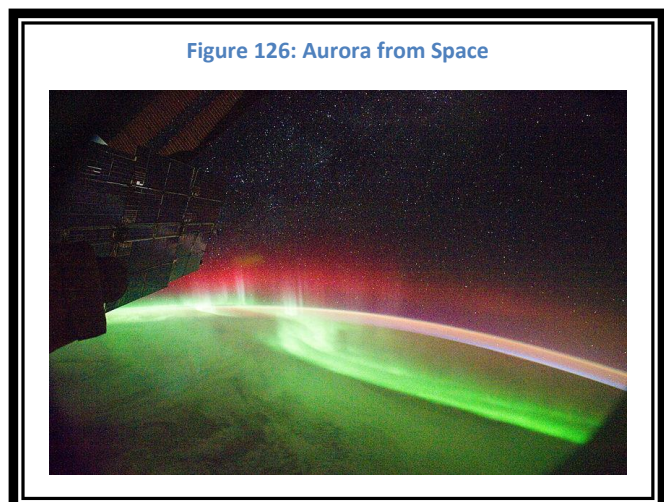
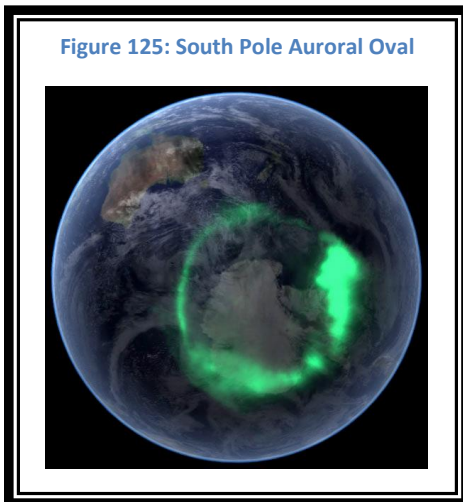


green and orange-red emissions. Collisions with nitrogen atoms in the atmosphere cause blue or red emissions.

As the charged particles travel down through the atmosphere different emissions tend to dominate. Initially, red oxygen emissions are most common followed by green oxygen emissions. These are followed by nitrogen blue emissions and finally by nitrogen red emissions.

This structure by altitude is very easily

visible in aurora pictures taken from space (see Figure 192).



## Component 46 – The Moon’s Data

### The Moon

- |                     |                               |                   |
|---------------------|-------------------------------|-------------------|
| • Mass              | 0.07342 x 10 <sup>24</sup> kg | (1.23 % of Earth) |
| • Equatorial Radius | 1738.1 km                     | (27.25 % Earth)   |
| • Surface Gravity   | 1.62 m/s <sup>2</sup>         | (16.5 % Earth)    |
| • Escape Velocity   | 2.38 km/s                     | (21.3 % Earth)    |

### The Moon’s Orbit

- |                       |                             |
|-----------------------|-----------------------------|
| • Semi-Major Axis     | 0.3844 x 10 <sup>6</sup> km |
| • Perigee             | 0.3633 x 10 <sup>6</sup> km |
| • Apogee              | 0.4055 x 10 <sup>6</sup> km |
| • Sidereal Month      | 27.32 days                  |
| • Synodic Month       | 29.53 days                  |
| • Orbital Inclination | 5.145 °                     |
| • Axial Tilt          | 6.68°                       |
| • Recession Rate      | 1.5 inches/year             |
| • Distance from Earth | 378,000 km                  |
| • Apparent Diameter   | 1896 arc-seconds            |
| • Apparent Magnitude  | -12.74                      |

*The Moon has no  
Magnetic Field*

*The Moon has a  
very thin  
Atmosphere*

### Th Moon’s Atmosphere

- |                         |              |                       |           |
|-------------------------|--------------|-----------------------|-----------|
| ○ Temperature Range     | 100 to 400 K |                       |           |
| ○ Composition:          |              |                       |           |
| ○ Helium                | 40,000 ppc   | ○ <sup>36</sup> Argon | 2,000 ppc |
| ○ <sup>20</sup> Neon    | 40,000 ppc   | ○ Methane             | 1,000 ppc |
| ○ Hydrogen <sub>2</sub> | 35,000 ppc   | ○ Ammonia             | 1,000 ppc |
| ○ <sup>40</sup> Argon   | 30,000 ppc   | ○ Carbon Dioxide      | 1,000 ppc |
| ○ <sup>22</sup> Neon    | 5,000 ppc    |                       |           |

**Note:** ppc is particle per cubic centimeter.

For the latest information on technical data for the moon, go to NASA’s website:

<http://nssdc.gsfc.nasa.gov/planetary/factsheet/moonfact.html>

## Component 47 – The Moon’s Origin

There have been many theories about how the moon formed over the years.

### Giant Impact Theory

The currently accepted scientific theory about the Moon’s origin is called the Giant Impact Hypothesis. This theory proposes that a large object, the size of Mars, impacted the Earth 4.5 billion years ago.

According to this theory, debris from the impact was ejected into space and over a relatively short time collected to form the moon. This theory is supported by the fact that the Moon seems to have a much smaller core than it should if it formed at the same time as the Earth formed.

### Alternative Theories

**Co-formation Theory.** One possible alternative is that the moon formed at the same time the Earth did from materials in the solar nebula. Although this used to be a popular theory, the Moon’s composition and structure should be the same as the Earth’s if they formed from the same material and at the same time.

**Capture Theory.** Another possibility is that the Moon was captured by the Earth from the debris in the solar nebula. There are many moons in the solar system that appear to have originated this way. In the case of the Moon though, its mass is too close to the mass of the Earth. This makes it unlikely that the Earth could have captured it.

**Fission Theory.** And yet another option is that the moon was ejected from the Earth. This is one of the oldest theories. The theory suggests that the Moon was originally part of the Earth in what is now the Pacific Ocean. This would mean that the Earth would have been rotating extremely fast to make this happen. There is no evidence that this was the case.

Figure 127: Giant Impact Theory



*The Moon was formed of debris from an impact on the Earth*

## Component 48 – The Moon's Structure

The moon has a differentiated structure similar to the Earth's. There is a Core, a Mantle, and a Crust.

### The Core

The Moon's **Core** is likely to be solid and mostly made of iron. It is a smaller percentage of the Moon than the Earth's core is of Earth. This means that if they were the same size, the Moon's core would still be smaller than the Earth's. The core has a radius of about 1050 km.

*The moon's core is smaller than it should be.*

Due to its slow rotation and possibly a solid core, the moon has no magnetic field.

*The Moon has no magnetic field.*

Small fields have been detected in localized areas.

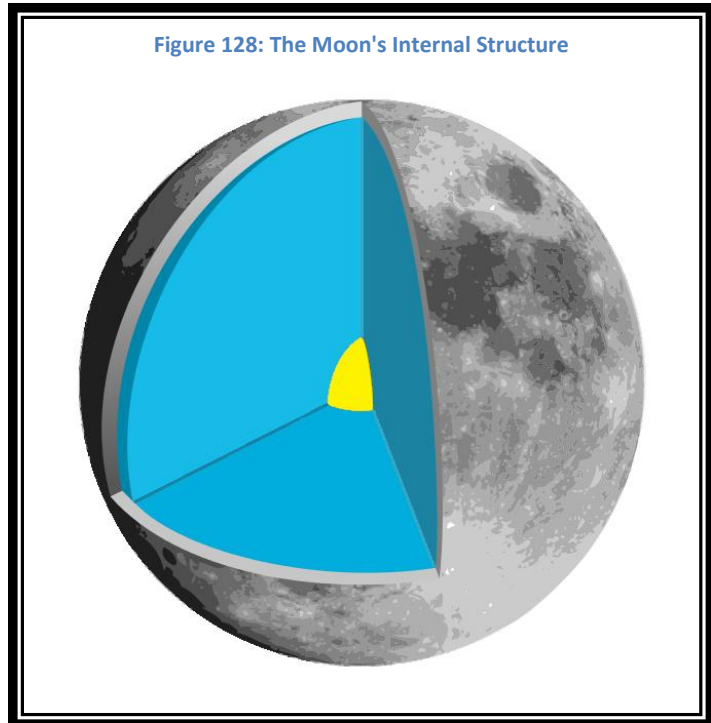
### The Mantle

The Moon has a rocky **Mantle** that has a thickness of about 1000 km.

### The Crust

The Moon's **Crust** is approximately 100 km thick at its thickest parts.

*For a free, downloadable virtual Moon atlas, go to website:  
<http://sourceforge.net/projects/virtualmoon/>*



## Component 49 – The Moon’s Surface

### Regolith

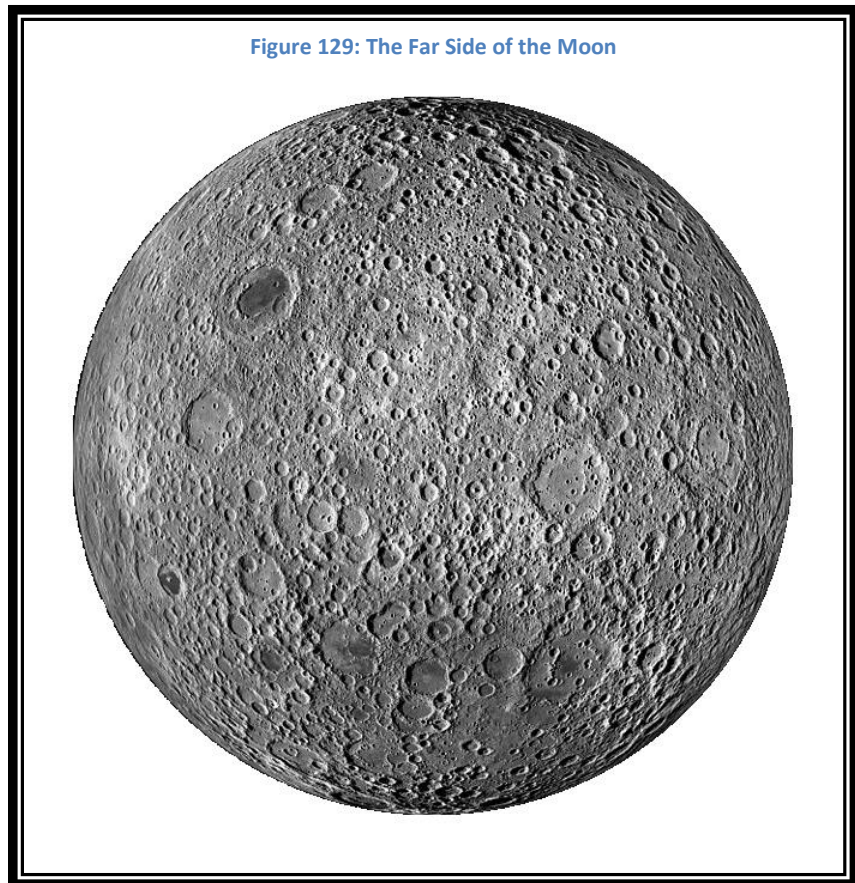
The Moon’s surface is covered with a thick dusty layer called **Regolith**. This is dust that has formed as a result of billions of years of **micrometeorite** bombardment. The Moon has no significant atmosphere, so there is no protection for the surface from these micrometeoroids.

### Atmosphere

The Moon is not very massive, and as a result has gravity which is much less than the Earth’s. Every object has an escape velocity, the speed at which something must be moving to escape from the gravity of the object. Molecules in the atmosphere around an object are in constant motion. If an object, like the Moon, is small, then molecules in its atmosphere may have sufficient velocity to escape from the object. Over billions of years, any atmosphere that might have existed on the Moon has escaped into space. With no atmosphere to protect it, and with no major erosion from water or wind, the surface of the Moon is largely the way it has been molded by impacts.

### The Far Side of the Moon

The **far side** of the Moon has many craters, but no major maria (plural form of mare). The Soviet Union was the first country to see the far side of the Moon so most of the features on the far side have Russian names.





## Naming Conventions

Most features on the moon have Latin Names. Some of the features are named:

- Oceanus – means ocean. The moon has only one: **Oceanus Procellarum**
- Mare – means sea. The moon has 13 **maria**.
- **Sinus** – means bay
- Lacus – means lake
- **Vallis** – means valley
- Palus – means marsh
- **Mons** – means mountain
- Montes – means mountain range
- Catena – means chain of craters
- Dorsa and Dorsum – means ridges
- Promontorium – means a piece of land that sticks out into a mare
- Rima – means rille
- Rimae – means rille system
- **Rupes** – means cliff

*Maria are large craters  
that filled in with magma  
3.9 billion years ago*

## The Near Side of the Moon

On the **near side** of the moon there are many large dark areas. Originally, the Moon was thought of as a planet like the Earth. If this were true, then the dark areas must be seas, or maria. In reality, 3.9 billion years ago, the Moon received heavy bombardment from debris in the inner solar system. Larger pieces of this debris were responsible for creating large and deep craters. These craters filled in with magma seeping up from inside the moon. It then hardened and is the maria we see today.

Figure 130: The Near Side of the Moon



Photo by Luc Viatour

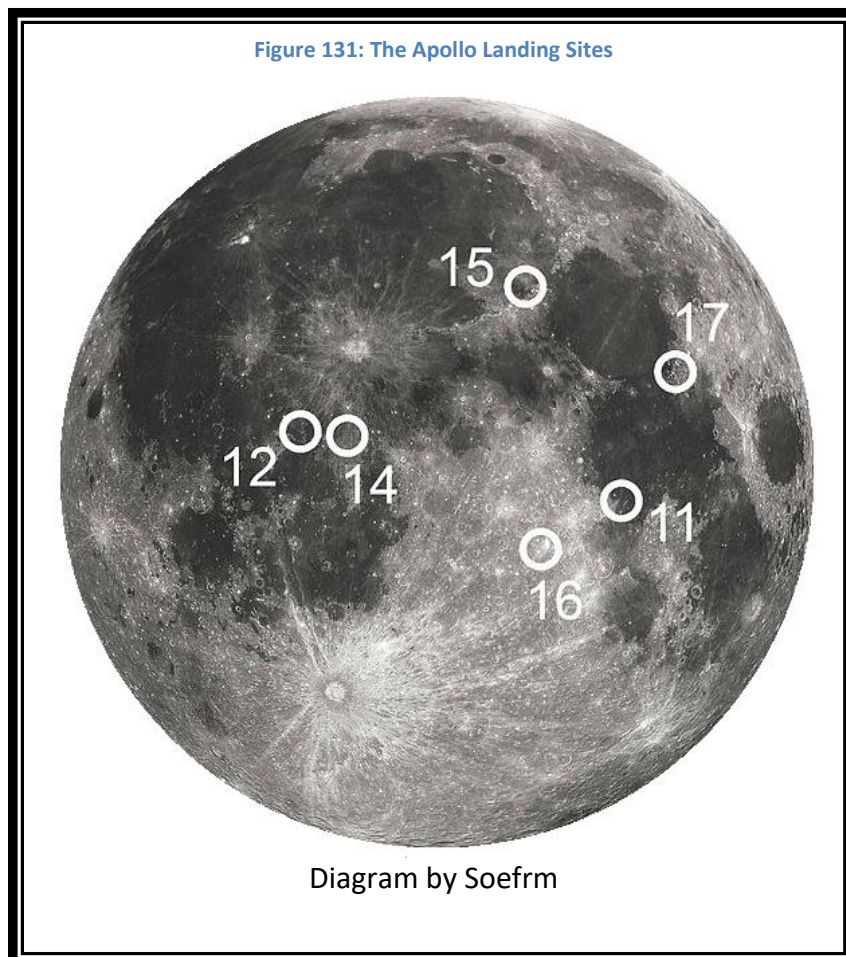
The lighter colored areas are referred to as the Highlands. If we assume that craters were created on the Moon evenly, then the highlands must be older than the maria because there are far fewer craters on the surface of the maria.

There are also two notable craters that are in Figure 196 and can be seen with the unaided eyes. In the highlands near the south is the crater Copernicus. In the maria farther north is the crater Tycho.

### The Apollo Landing Sites

Six Apollo crews landed on the moon between 1969 and 1972. A total of **twelve** people have walked on the Moon. Their landing sites are shown in Figure 197. They brought back many pounds of Moon rocks.

*Only 12 humans have walked on the Moon*



## Component 50 – Tidally Locked

Objects that orbit each other have an effect on each other caused by their gravity. The Moon's gravity is responsible for tides on the Earth. But the Earth's gravity also has an effect on the Moon. The eventual outcome of these effects is to cause tidally locked objects.

### Synchronous Orbit

Over billions of years the gentle tugs of Earth's gravity have slowed the **rotational period** of the Moon until it is now equal to the **orbital period**. They are equal to 27.3 days. The Moon is in a synchronous orbit around the Earth and is **tidally locked**.

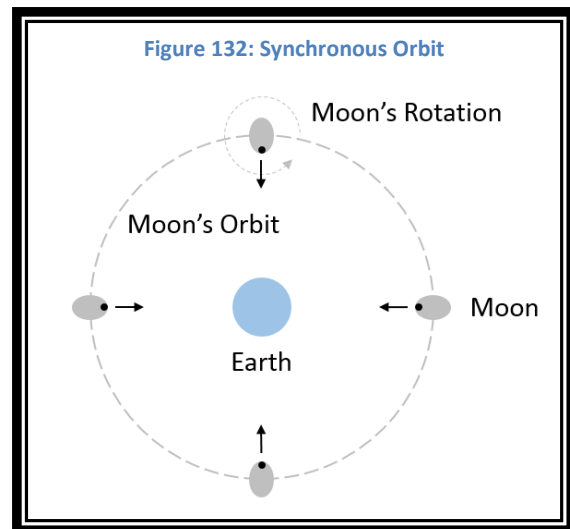
Very accurate measurements of the distance to the moon indicate that it is still receding at 1.5 inches per year.

Most moons in the solar system are in synchronous orbits with their planets.

### Tidal Bulge

The Earth creates a tidal bulge on the moon. The size of this bulge implies that the Moon was much closer to the Earth in the past.

*The Moon rotates at exactly the same rate as its orbital period: 27.3 days. The same side of the Moon always faces Earth.*



*The Moon's gravity is decreasing the Earth's rotation. The Earth will be tidally locked to the Moon.*

### Impact on the Earth

The Moon is also imparting gentle tugs on the Earth. The Moon is smaller than the Earth, so the size of the tugs as well as the effects of these tugs is smaller. But they accumulate over billions of years. Eventually, this would result in the Earth being tidally locked to the Moon as

well. This means that when this occurs, the Moon will be in the same place in the sky all the time. The Earth will rotate at the same rate that the Moon orbits the Earth.

## Component 51 – Mercury’s Data

### Mercury

- Mass 0.3301 x 10<sup>24</sup> kg (5.53 % Earth)
- Equatorial Radius 2439.7 km (38.3 % Earth)
- Surface Gravity 3.7 m/s<sup>2</sup> (37.8 % Earth)
- Escape Velocity 4.3 km/s (38.4 % Earth)
- Number of Natural Moons 0

### Mercury’s Orbit

- Semi-Major Axis 59.7 x 10<sup>6</sup> km (38.7 % Earth) 0.387 AU
- Sidereal Orbital Period 88 days (24.1 % Earth)
- Tropical Orbit Period 88 days (24.1 % Earth)
- Synodic Period 115.88 days
- Perihelion 46 x 10<sup>6</sup> km (31.3 % Earth)
- Aphelion 69.82 x 10<sup>6</sup> km (45.9 % Earth)
- Sidereal Day 1407.6 hours
- Solar Day 4222.6 hours
- Axial Tilt 0.034°
- Orbital Inclination 7.0 °

*Mercury has  
a very thin  
Atmosphere*

### Magnetosphere

- Field Strength 0.0019 gauss-Rh<sup>3</sup>
- Tilt to Axis 4.5 °

### Mercury’s Atmosphere

- Average Temperature 440 K
- Composition (very thin atmosphere):
  - **Oxygen** 42 %
  - **Sodium** 29 %
  - **Hydrogen** 22 %
  - **Helium** 6 %
  - Potassium 0.5 %

For the latest information on technical data for Mercury, go to NASA’s website:

<http://nssdc.gsfc.nasa.gov/planetary/factsheet/mercuryfact.html>

## Component 52 – Mercury's Structure

Mercury has a differentiated structure similar to the Earth's. There is a Core, a Mantle, and a Crust.

**Core.** Mercury's Core is likely to be solid and mostly made of iron. It is a larger percentage of Mercury than the Earth's core is of Earth. This means if they were the same size, Mercury's core would be much larger than the Earth's. The core has a radius of about 1800 km.

*Mercury's core is larger than it should be.*

Due to its slow rotation, Mercury should

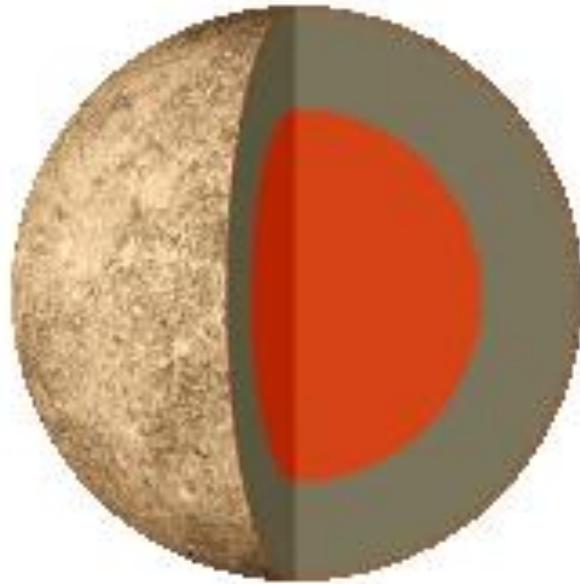
have no magnetic field. We have detected a small magnetic field, about 1/100<sup>th</sup> that of the Earth's. Scientists were surprised because they did not expect there to be any magnetic field since Venus, the Moon, and Mars did not have a magnetic field at all. It is believed that tidal forces due to Mercury's eccentric elliptical orbit and proximity to the Sun would be able to keep the core liquid. This would permit a dynamo action and magnetic field.

Like the Moon, the prevailing theory of how Mercury formed is as a result of an impact with a large object roughly 1/6 its size. The impact ejected much of the mantle into space leaving the core fairly intact.

**Mantle.** Mercury has a rocky Mantle that has a thickness of about 60 km.

**Crust.** Mercury's Crust is from 100 to 300 km thick.

Figure 133: Mercury's Internal Structure



*Mercury has a very weak magnetic field.*

## Component 53 – Mercury’s Surface

### Surface Features

Mercury’s surface is quite similar to the moon’s surface. It is heavily cratered. There are no maria. In addition to the craters, Mercury’s surface has a cliff feature called a **scarp**. The scarps were likely a result of shrinkage of the surface of Mercury as the planet cooled. The scarps cut across multiple craters indicating that the scarp is newer. Mercury appears to have formed about 4 billion years ago. There is evidence of volcanism on Mercury, but the volcanic processes seem to be different than on the moon.

Figure 135: Mercury’s Caloris Basin



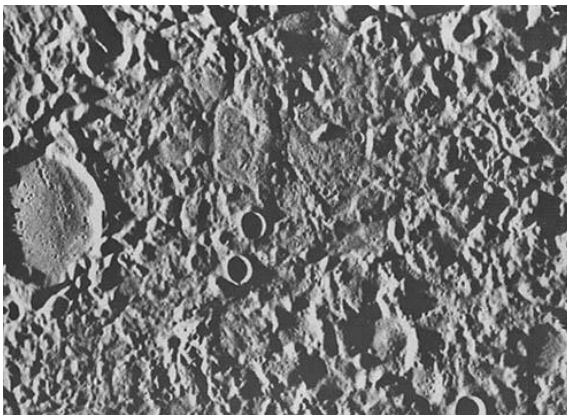
There is a large basin on Mercury called the **Caloris Basin**. It is roughly half the size of Mercury’s radius and is 1400 km in diameter. The Caloris Basin can be seen in the upper right of Figure 201. It was likely due to an impact by a large asteroid. The impact apparently was so violent that seismic waves travelled through the planet. Where they merged on the opposite side of the planet they disrupted the surface and produced a rippled surface called “**Weird Terrain**”.

### Mercury’s Atmosphere

Mercury has a very thin atmosphere. Due to its

small mass and gravity it is possible for lighter atoms to reach escape velocity and to escape into space.

Figure 134: Mercury’s Weird Terrain



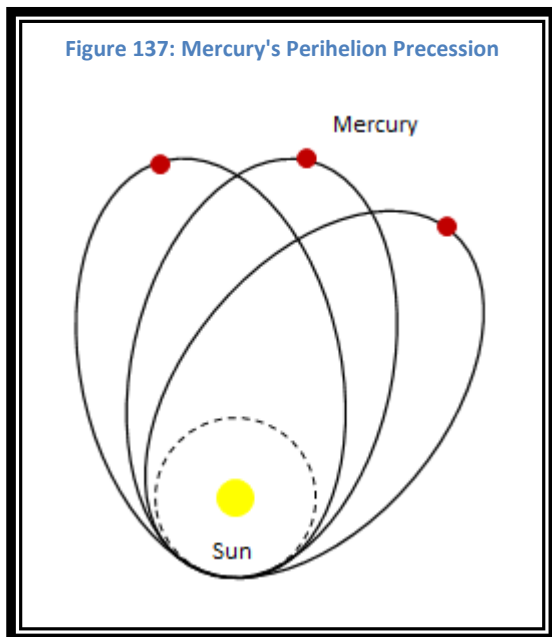
*Mercury’s primary surface feature is Caloris Basin and the associated Weird Terrain on the other side of the planet*

## Component 54 – Mercury's Orbit

Mercury's orbit is the most eccentric of the planets.

### Orbital Resonance

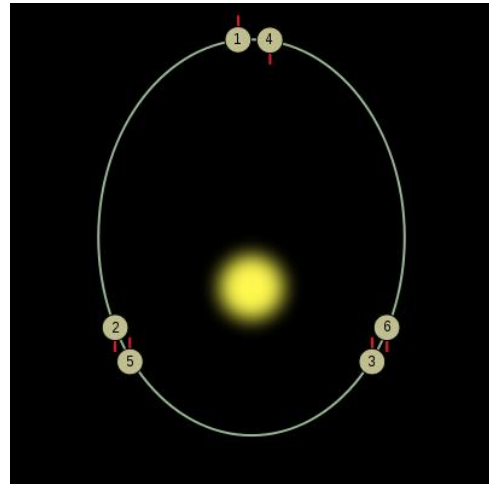
Mercury is in a spin-orbital resonance. In every two revolutions around the Sun there will be three rotations by Mercury on its axis. This is caused by tidal effects from the gravity of the Sun as well as gravitational tugs by the planets.



The precession is  $1.5436^\circ$  per century. Newton's laws can't explain all of this precession. It was Einstein's Theory of Relativity that finally solved the missing piece.

*Mercury exhibits a complete set of phases*

Figure 136: Mercury's Spin-Orbit Resonance



*Mercury is in 3-2 Spin-Orbit Resonance*

### Perihelion Precession

Each orbit of Mercury around the Sun results in a small precession of Mercury's Perihelion. The

*Mercury has Perihelion Precession*

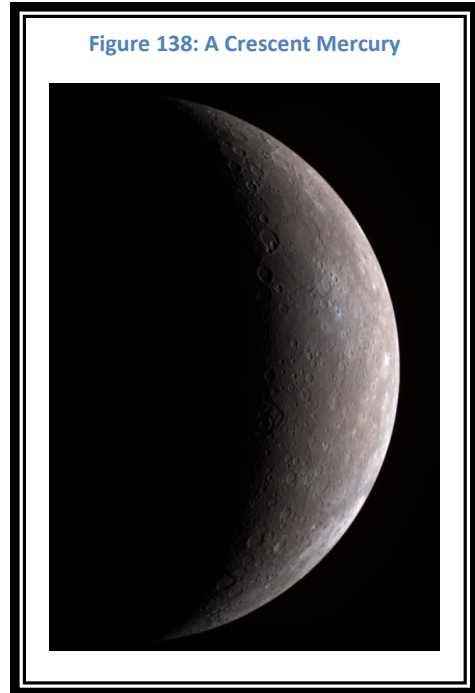
**Mercury's Phases and Transits**

Like the Moon, Mercury exhibits phases as it orbits the sun. The time it takes to traverse all of the phases and return to the beginning is called the Synodic Period and its period is 115.88 days. It is a function of Mercury's orbit as well as the Earth's orbit. On an average of once every 7 years, Mercury is perfectly aligned and crosses the sun's

**Table 12: Transits of Mercury**

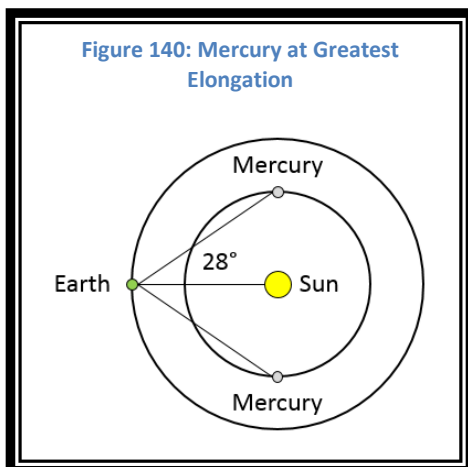
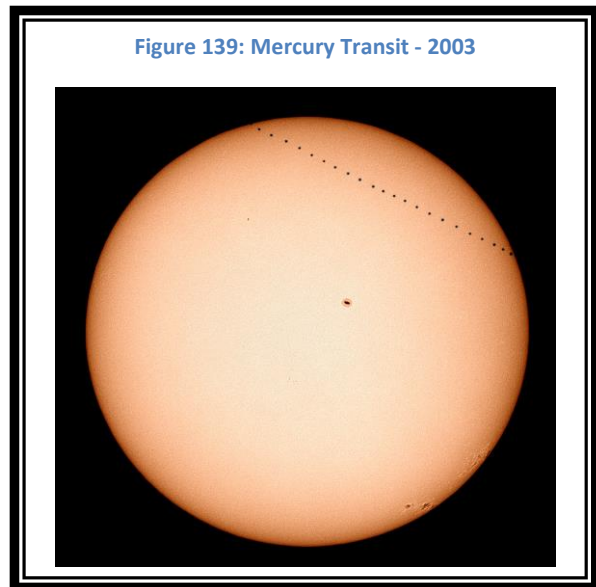
Date and start time (UT)
November 8, 2006 – 19:12
May 9, 2016 – 11:12
November 11, 2019 – 12:35
November 13, 2032 – 06:41
November 7, 2039 – 07:17

disk. This is called a **Transit**. Table 12 shows Transits of Mercury through 2040. The times are in Universal Time.



**Mercury's Greatest Elongation**

As Mercury orbits the Sun it never strays far from the Sun in the sky. This is because it is an inner planet, closer to the Sun than the Earth is. From our perspective Mercury oscillates back and forth past the Sun. At times it is a morning object and at other times it is an evening object. The points where it is furthest from the Sun are referred to as Greatest Elongation. For Mercury, the Greatest Elongation is 28 °.



*Mercury's Greatest Elongation is 28 °*



## Component 55 – Venus’ Data

### Venus

- Mass 4.8676 x 10<sup>24</sup> kg (81.5 % Earth)
- Equatorial Radius 6051.8 km (94.9 % Earth)
- Surface Gravity 8.87 m/s<sup>2</sup> (90.5 % Earth)
- Escape Velocity 10.36 km/s (92.6 % Earth)
- Number of Natural Moons 0

*Venus has Retrograde Rotation*

### Venus’ Orbit

- Semi-Major Axis 108.21 x 10<sup>6</sup> km (72.3 % Earth) 0.723 AU
- Sidereal Orbital Period 224.7 days (61.5 % Earth)
- Synodic Period 583.92 days
- Perihelion 107.5 x 10<sup>6</sup> km (73.1 % Earth)
- Aphelion 108.9 x 10<sup>6</sup> km (71.6 % Earth)
- Sidereal Day 5832.6 hours
- Solar Day 2802 hours
- Axial Tilt 177.36°
- Orbital Inclination 7.0 °
- Apparent Magnitude -4.6
- Angular Diameter 9.7 to 66 arc-seconds

*Venus has a very thick Atmosphere*

*Venus’ diameter is almost the same as the Earth’s*

### Venus’ Atmosphere

- Average Temperature 737 K
- Composition (very thick atmosphere):
  - **Carbon Dioxide** 96.5 %
  - **Nitrogen** 3.5 %
  - **Sulfur Dioxide** 150 ppm
  - Argon 70 ppm
  - Water 20 ppm
  - Carbon Monoxide 17 ppm
  - Helium 12 ppm
  - Neon 7 ppm

*Venus has no magnetic field due to its very slow rotation*

For the latest information on technical data for Venus, go to NASA’s website:

<http://nssdc.gsfc.nasa.gov/planetary/factsheet/venusfact.html>

## Component 56 – Venus' Structure and Surface

### Structure

Venus' internal structure is probably very similar to the Earth's. There is likely a Core, a Mantle, and a Crust, all with similar dimensions to Earth's. Venus has no detectable magnetic field. This is likely due to the planet's very slow rotation rate.

### Surface

It is hard to get information about the surface of Venus. The planet's thick cloud cover makes visual observation impossible.

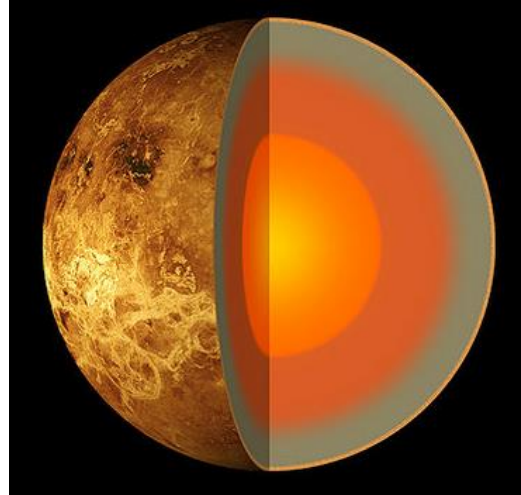
The Soviet Union did land spacecraft on the surface of Venus, but the temperatures make for very short lifetimes. These landers have sent back information from Venus:

- Vanera 8, 1972: 50 minutes – information on surface temperature and pressure.
- Vanera 9, 1975: 53 minutes– first picture of surface.
- Vanera 10, 1975: 63 minutes – more detail on surface conditions.
- Vanera 13, 1981: 127 minutes – details on the surface materials.
- Vanera 14, 1981: 57 minutes – details on the surface materials.

It has also been possible for orbiters to map the surface using radar that sees through the thick cloud cover.

The surface of Venus is rocky, hot and dry. There is no evidence of tectonic activity. The theory for this is that the temperature of the surface makes the crust softer than the Earth's Crust and makes it difficult for plate tectonics to develop. It is also possible that the excess temperature has prevented Venus from cooling as the Earth did, and this would slow the development of tectonic processes.

Figure 141: Venus' Internal Structure



*Venus shows no  
Tectonic Plate activity*

Figure 143: Venus Volcano: Sif Mons

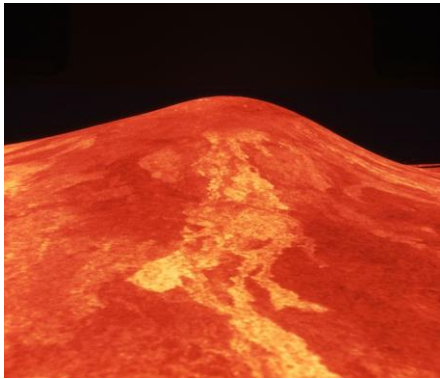
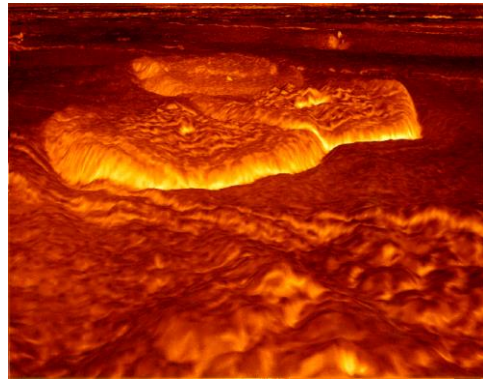


Figure 142: Venus Pancake Volcano, Alpha Regio



There is much evidence of volcanic activity on the surface of Venus. The evidence consists of volcanos such as Sif Mons, pancake volcanos like the ones on the edge of Alpha Regio, and Coronae such as the Aine Corona.

There is also evidence of impact craters on the surface of Venus. The largest crater is called Mead. It has two crater walls and is 174 miles in diameter.

Venus has phases as does the Moon and

*Venus has much evidence of volcanic activity*

Figure 144: The Aine Corona



Mercury because it orbits inside of Earth's orbit.

It completes a set of phases (the Synodic Period) in 19 months. Because of the large change in distance from Inferior Conjunction to Superior Conjunction, the size of Venus is radically different from its New phase to its Full phase. It is almost 7 times larger when it is approaching the New phase than when it is Full.

Figure 145: Venus' Crater Mead

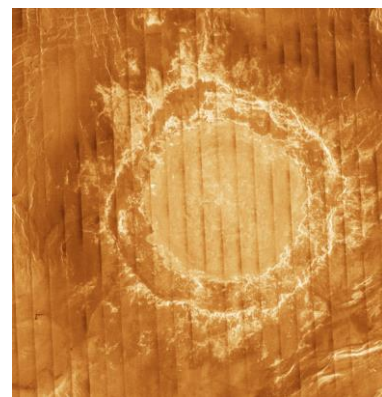


Figure 146: Venus Phases



Chart by Stasis Kalyvas

Figure 212 shows a comparison of the size of Venus during its different phases. The crescent is so large it is easily visible in a pair of binoculars. Also Venus is its brightest when it is a thin crescent. This is because although the percent illuminated is small, the closeness of the planet means it is so much larger that more light is reflected to Earth.

*Venus is Brightest when  
it is a Thin Crescent*

## Component 57 – Venus' Orbit and Orientation

Venus has the most circular orbit of all of the planets in the solar system. But it also has some unusual features as well. The planet has **retrograde** rotation because it rotates in a different direction than most of the planets in our solar system. Its rotation rate is very slow. This rotation speed and direction is believed to be from an impact with a large object early in the formation of the solar system. Its orbital period is just a bit less than 225 days, but its sidereal day is 243 days. This means that a day on Venus is longer than a year.

### Venus' Axial Tilt

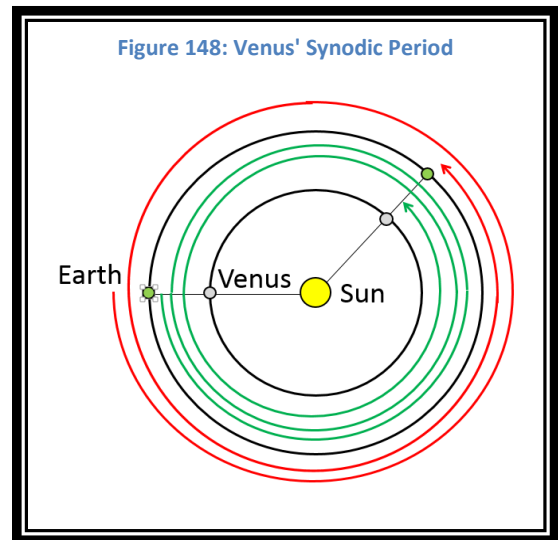
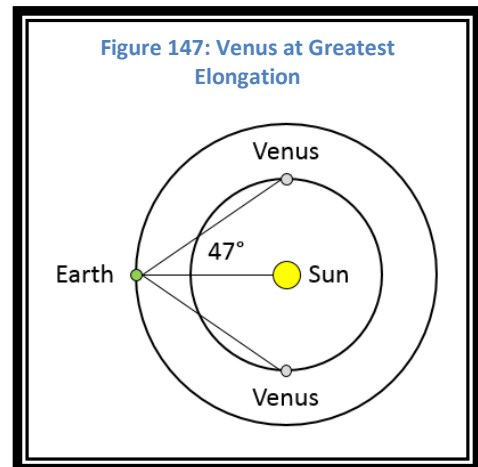
Venus has an axial tilt of  $177^\circ$ . This means that its north pole is pointing downward compared to most of the other planets. Since the axis of rotation is pointing below the plane of its orbit, the planet is rotating clockwise rather than counterclockwise. This means that Venus has retrograde rotation.

### Venus' Greatest Elongation

As Venus orbits the sun, as an inner planet, it never gets more than  $47^\circ$  away from the sun. This is its Greatest Elongation.

### Venus' Synodic Period

The time it takes an object to progress from its full phase back to its full phase is its Synodic Period. Venus' Synodic Period is 583.92 days. Because the phases or nodes are defined by the position of Venus and the Sun as well as the location of the Earth, this takes longer than one orbit around the sun. As Venus moves in its orbit, the Earth is moving in its orbit as well. In order for Venus to return to the same orientation relative to the Earth and the Sun it must travel further than just a single orbit to get there. When Venus has completed its first orbit, the Earth has moved around its orbit only  $225^\circ$ . At the end of Venus' second orbit, the Earth is now almost a quarter of a way into its second orbit. Venus has not caught up with it yet. They align again after another 140 days, or a total of 584 days.



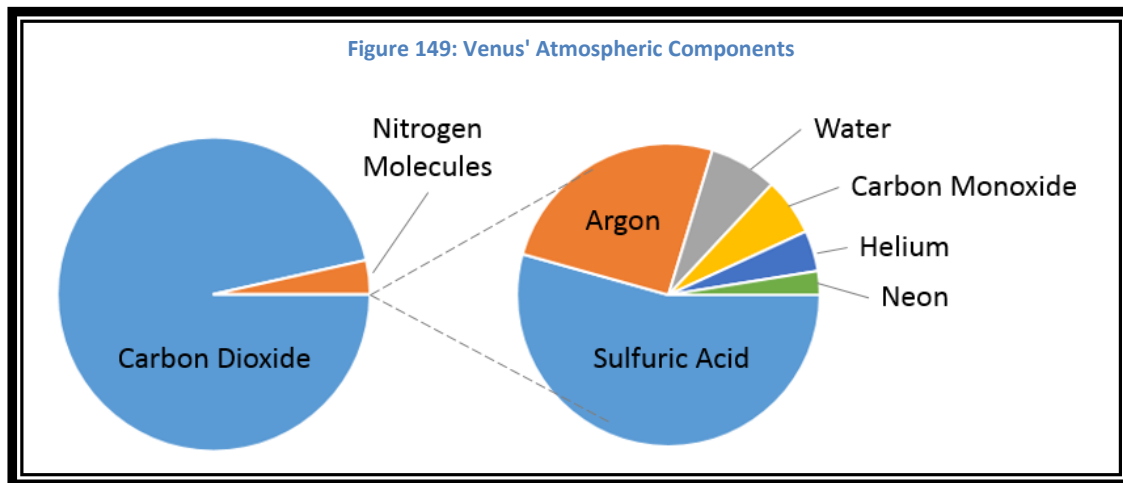
## Component 58 – Venus’ Atmosphere

### Thick Carbon Dioxide Atmosphere

Venus has a very thick atmosphere. It is mostly composed of Carbon Dioxide. Carbon Dioxide is a very effective Greenhouse Gas. Venus’ thick atmosphere absorbs almost all of the infrared radiation emitted from the surface. This heat is retained and not allowed to escape into space and as a result the temperature at the surface of the planet is quite high. This thick atmosphere is very effective at spreading the heat throughout the planet’s atmosphere. The dark side of Venus is as hot as the sunlit side and the poles are as hot as the equator.

Table 13: Venus’ Atmosphere Components

Carbon Dioxide	96.5 %
Nitrogen Molecules	3.5 %
Sulfuric Acid	0.015 %
Argon	0.007 %
Water	0.002 %
Carbon Monoxide	0.0017 %
Helium	0.0012 %
Neon	0.0007 %



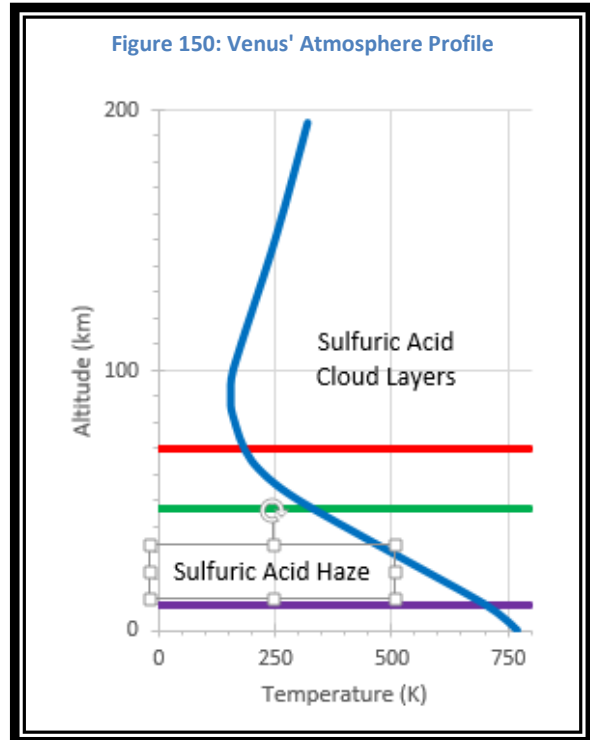
### Why Venus is so Different?

Venus is very similar to the Earth in size and composition. When the planets formed they would probably have been very similar. Venus is closer to the Sun and would receive more radiation from the Sun. As the planet was evolving, it would have had a large amount of carbon dioxide. But when the temperature is higher, the rocks would absorb less carbon dioxide. Also, the temperature may have been high enough that the water would not be liquid on the surface but would be water vapor in the atmosphere. These two gases would increase the Greenhouse Effect. As the planet continued to heat, the water vapor would have risen to the upper layers of the atmosphere. Here it would be bombarded with ultraviolet radiation. The molecules

would have been destroyed and split into hydrogen and oxygen. The hydrogen would have escaped into space and the oxygen would have combined with other atoms and molecules in the atmosphere. At this point, Venus would look much more like it does today, and very different from the Earth. The water is mostly gone, and the carbon dioxide levels would be high.

### Venus' Temperature Profile

There is a great deal of **sulfuric acid** in Venus' atmosphere. This makes for a very hazardous atmosphere that will destroy many materials. These clouds also make the planet appear solid white in telescopes on Earth. It is so thick that no surface details are visible from Earth. As you move away from the surface and above the Troposphere (moving above the violet line in Figure 216) the temperature drops steadily until you reach an altitude of about 100 km. At this point the temperature again begins to rise due to radiation penetrating the upper levels of the atmosphere.



## Component 59 – Mars’ Data

### Mars

- Mass  $0.642 \times 10^{24}$  kg (10.7% Earth)
- Equatorial Radius 3396.2 km (53.2 % Earth)
- Surface Gravity  $3.71 \text{ m/s}^2$  (37.9 % Earth)
- Escape Velocity 5.03 km/s (45.0 % Earth)
- Number of Natural Moons **2 (Phobos and Deimos)**

### Mars’ Orbit

- Semi-Major Axis  $227.92 \times 10^6$  km (152.4 % Earth) 1.5 AU
- Sidereal Orbital Period 687 days (188.1 % Earth)
- Synodic Period 780 days
- Perihelion  $206.62 \times 10^6$  km (140.5 % Earth)
- Aphelion  $249.23 \times 10^6$  km (163.9 % Earth)
- Sidereal Day 24.62 hours (103 % Earth)
- Solar Day 24.66 hours (103 % Earth)
- Axial Tilt  $25.19^\circ$  (107.5 % Earth)
- Orbital Inclination  $1.85^\circ$
- Apparent Magnitude -2.91 (maximum)
- Angular Diameter 3.5 to 25.1 arc-seconds

*A day on Mars is almost the same length as on Earth*

### Mars’ Atmosphere

- Average Temperature 210 K
- Composition (very thin atmosphere):
  - **Carbon Dioxide** 95.32 %
  - **Nitrogen** 2.7 %
  - **Argon** 1.6 %
  - Oxygen 0.13 %
  - Carbon Monoxide 0.08 %
  - Water 210 ppm
  - Nitrogen Oxide 100 ppm
  - Neon 2.5 ppm

*Mars has no Magnetic Field probably due to a solid core*

For the latest information on technical data for Mars, go to NASA’s website:

<http://nssdc.gsfc.nasa.gov/planetary/factsheet/marsfact.html>



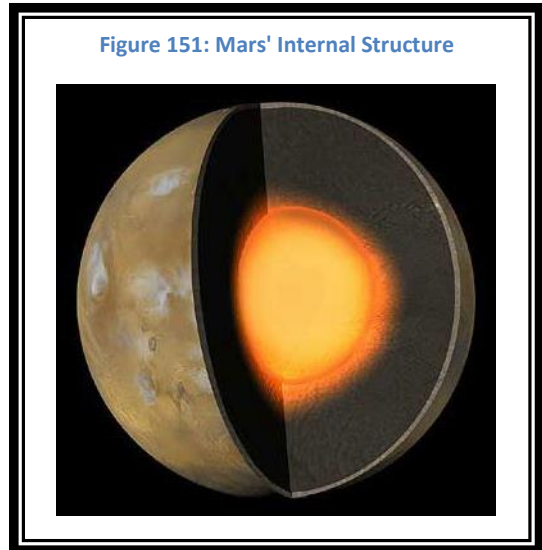
## Component 60 – Mars' Structure

Mars has an internal structure similar to the other terrestrial planets. The **Core** has a radius of 1800 km. Its **Mantle** is 1490 km thick and Mars' **Crust** is 50 to 100 km thick.

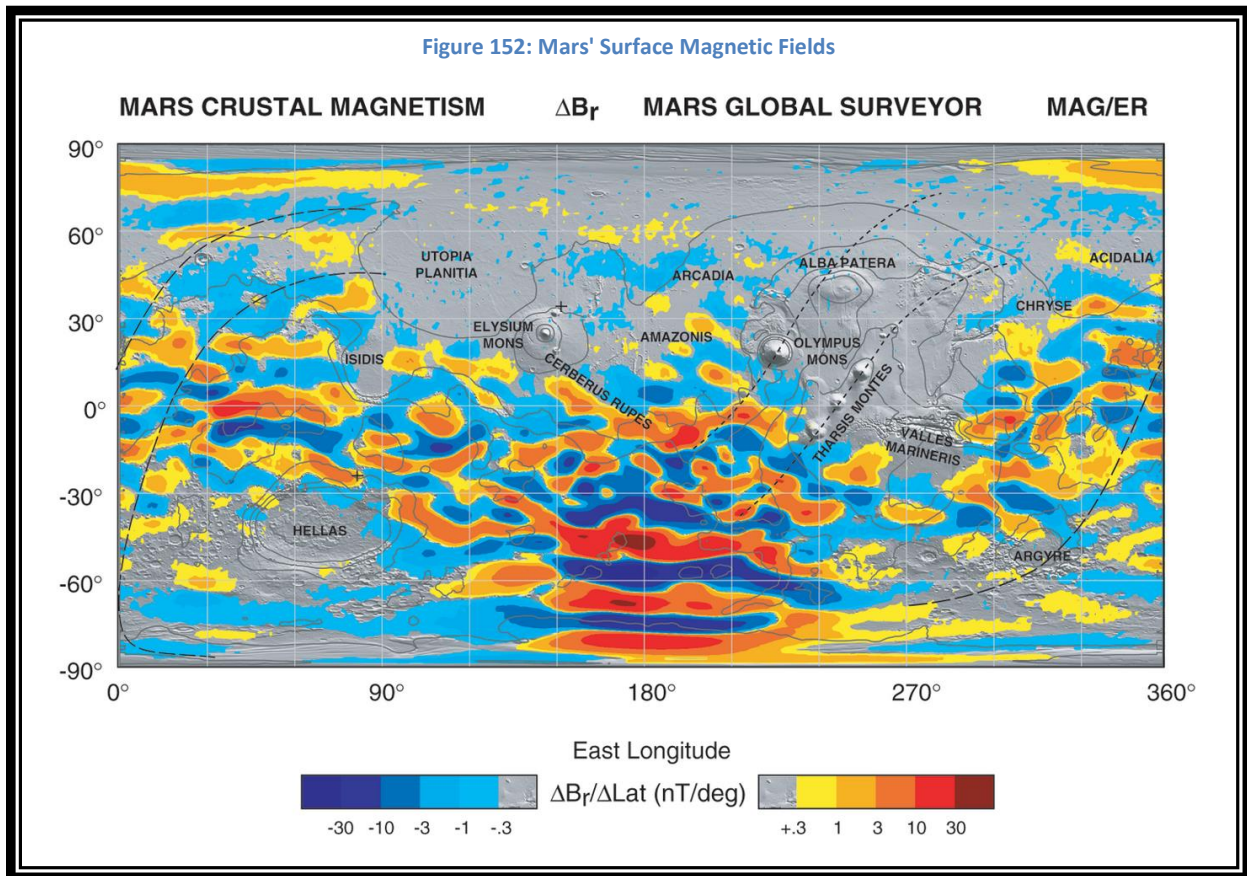
The core is made up of mostly iron and nickel with a large amount of sulfur. This material is believed to be largely solid.

The mantle consists of mostly silicates.

The crust is much thicker than the Earth's crust and contains iron oxide (rust) that gives the planet its characteristic reddish color.



Today Mars is not volcanically active and does not have plate tectonics. It has no planetary magnetic field, but has evidence of surface magnetic fields (see Figure 218).



## Component 61 – Mars' Atmosphere

Mars has a thin atmosphere, but it is thick enough to support **sand storms** and small dust tornadoes. There are times during the Martian year when **Carbon Dioxide Ice Clouds** and **Water Ice Clouds** form in the Troposphere and lower Stratosphere.

Figure 154: A Martian Sandstorm (2001)

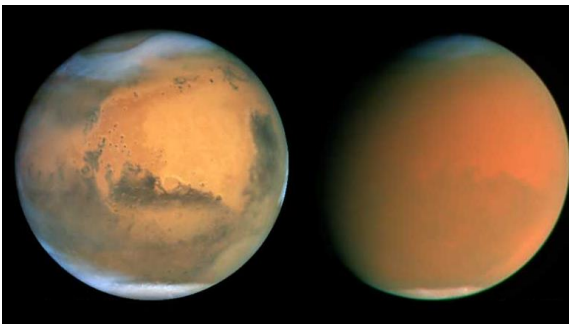


Table 14: Martian Atmospheric Composition

Carbon Dioxide	95.32 %
Nitrogen	2.7 %
Argon	1.6 %
Oxygen	0.13 %
Carbon Monoxide	0.08 %
Water	210 ppm
Nitrogen Oxide	100 ppm
Neon	2.5 ppm

Figure 153: Mars' Atmosphere Profile

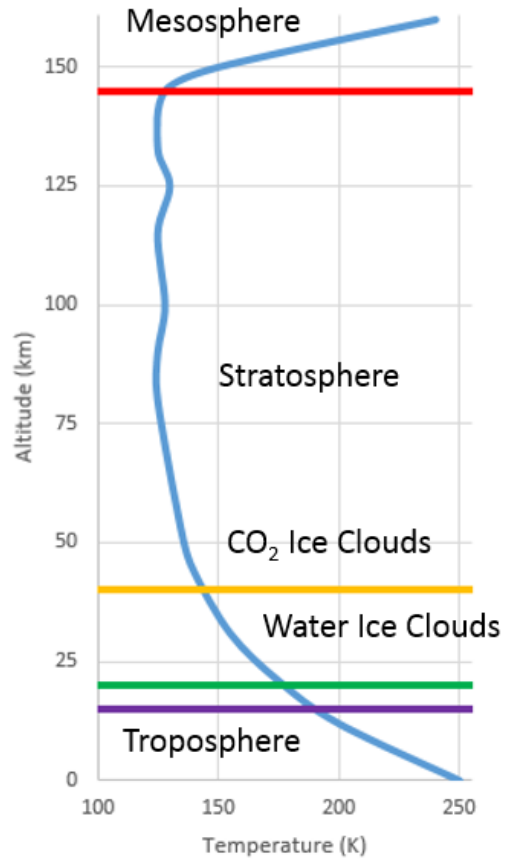
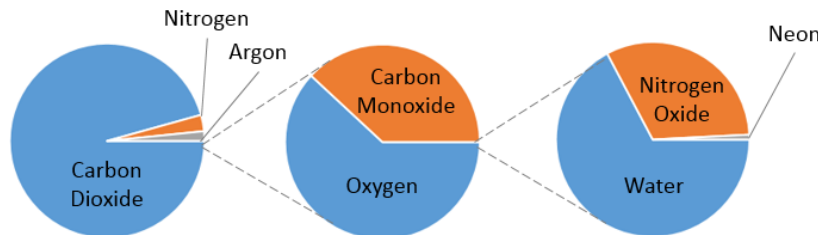
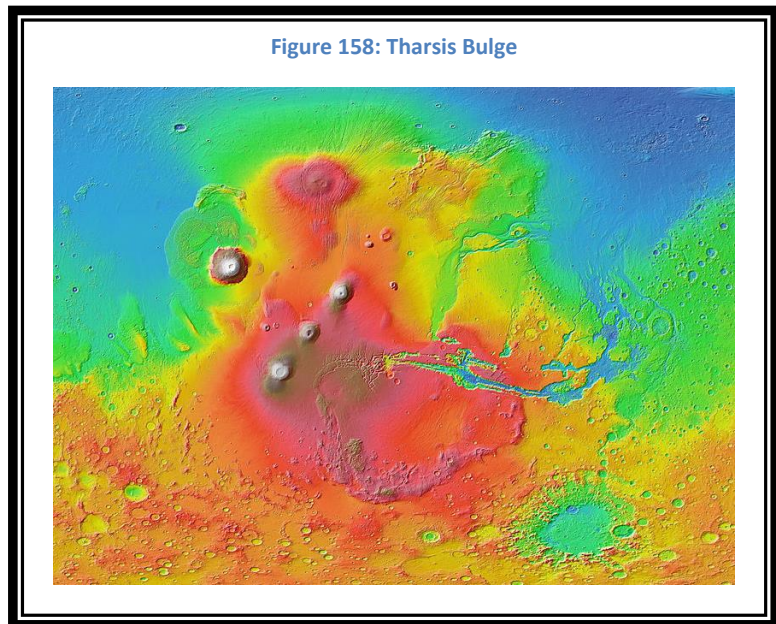
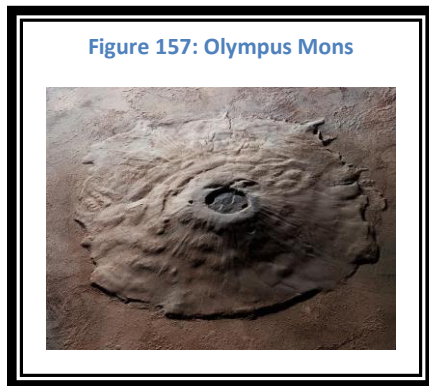
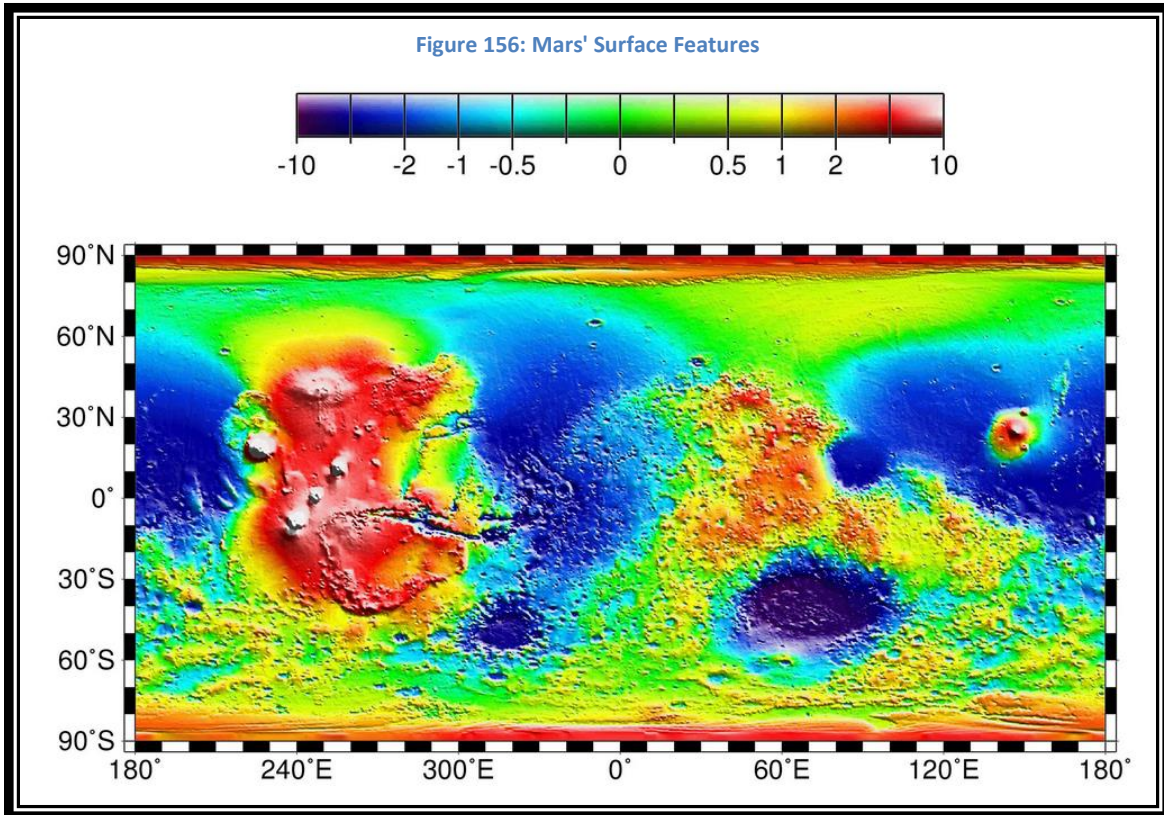


Figure 155: Mars' Atmospheric Composition



## Component 62 – Mars' Surface

Mars' surface has some of the most significant features among the terrestrial planets and moons.



## Volcanoes

The largest volcano in the Solar System is **Olympus Mons**. It has a diameter of roughly 600 km and a height of 26 km. This means that it is three times taller than Mount Everest, the highest peak on Earth. It is a shield volcano that would fit snugly in the state of Texas. It is located in the Martian highlands known as the Tharsis Bulge. This is a bulge caused by volcanic material pushing up on the surface.

*The largest volcano in the solar system, Olympus Mons is located on Mars*

## The Tharsis Bulge

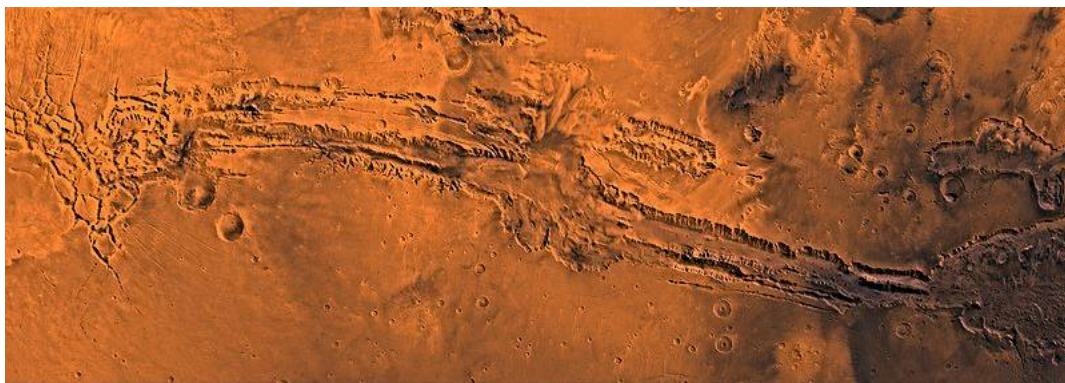
The **Tharsis bulge** is home to four large volcanoes and the largest valley in the solar system, the Valles Marineris. In Figure 224, Olympus Mons is located in the upper left quadrant. The three other large volcanoes from right to left are: Ascraeus Mons (480 km wide and 18.1 km high), Pavonis Mons (375 km wide and 17 km high) and Arsia Mons (435 km wide and 20 km high).

*The largest valley in the solar system, Valles Marineris is located on Mars*

## Valles Marineris

The **Valles Marineris** is 4000 km long, 200 km wide and 7 km deep. It was not formed by running water, but is a rift valley. It formed as a result of the formation of the Tharsis Bulge. Volcanic activity created the bulge, but as the upward pressure declined, the crust became too heavy for the crust to be supported. The crust fractured and resulted in the Valles Marineris we see today (see Figure 225). Its length is equal to the width of the United States and cuts across one entire face of Mars. For comparison, the Earth's Grand Canyon is only 446 km long and would easily fit into one of the side canyons of Valles Marineris.

Figure 159: Valles Marineris

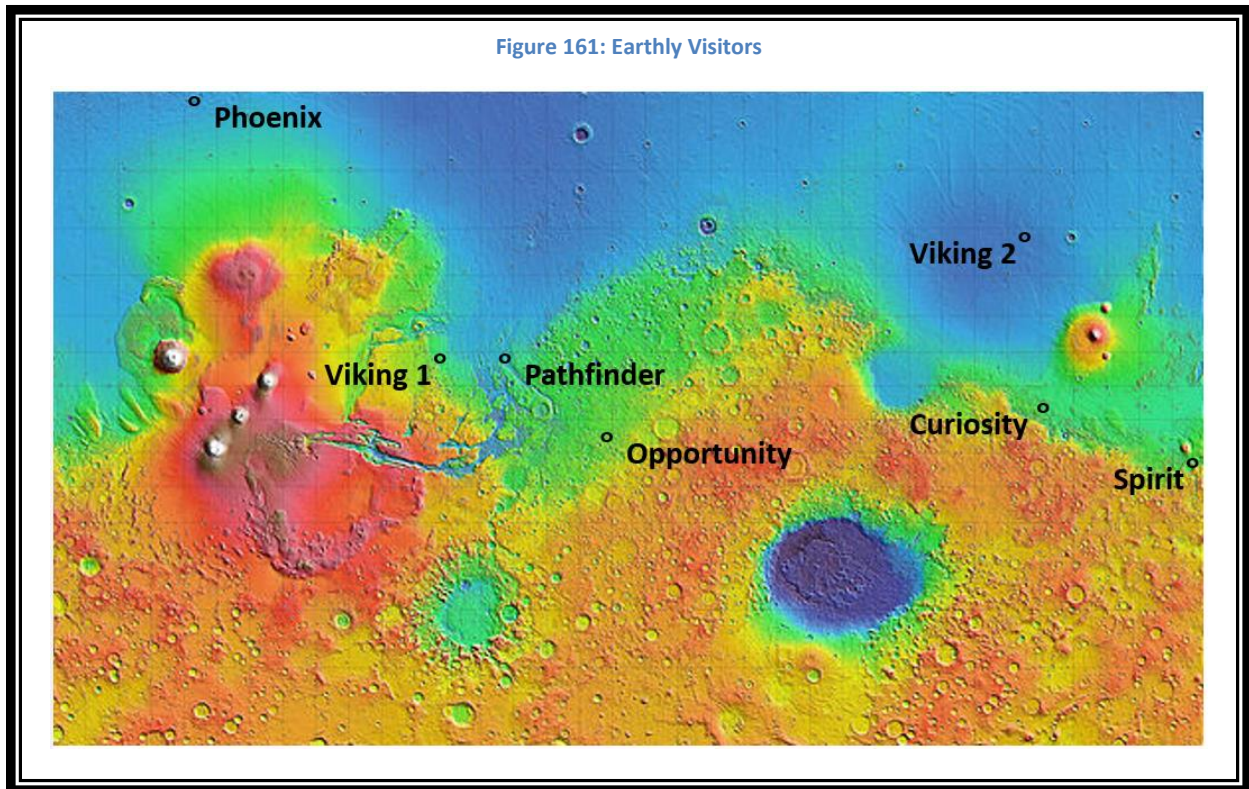
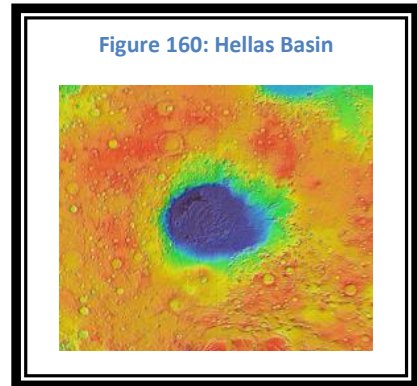


### Hellas Basin

Another major geographic feature on the surface of Mars is the **Hellas Basin** (see Figure 226). This crater has a diameter of 2200 km and is 7 km deep. It is located in the Hellas Planitia.

### Earthly Visitors

Many landers and rovers have been sent to Mars. The most notable ones are shown in Figure 227. The primary role of these spacecraft is to find signs of water.



Some of these spacecraft are shown here:

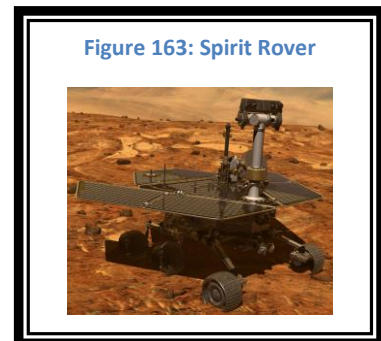
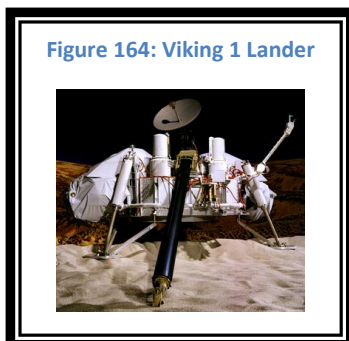


Figure 165: Opportunity Rover's Travels



Figure 166: Phoenix Lander

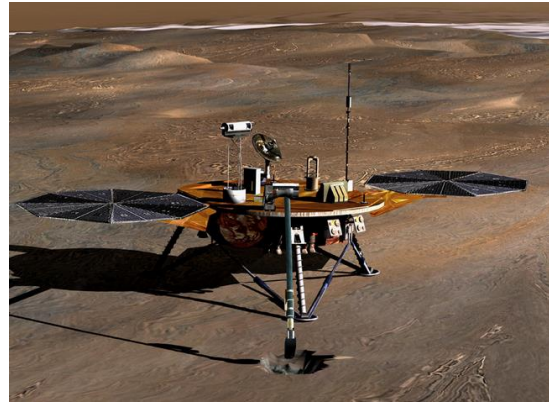
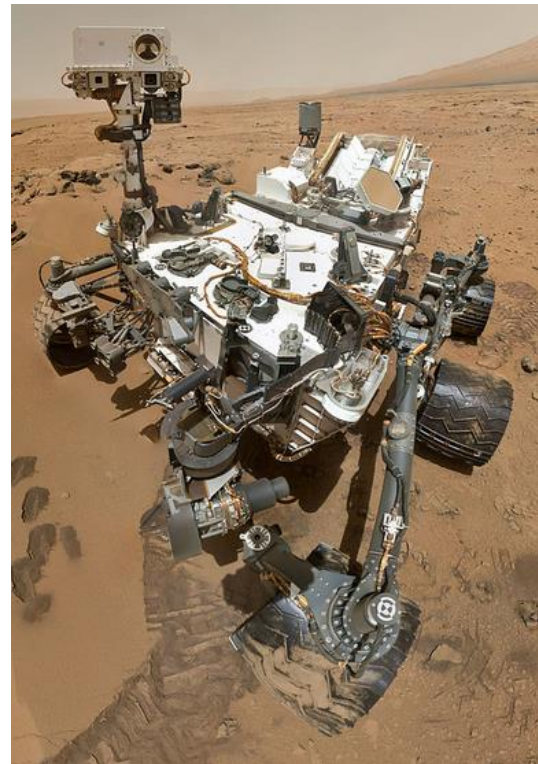
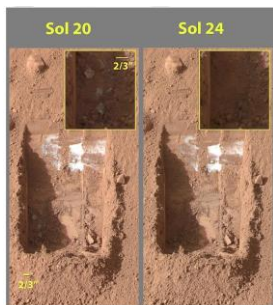


Figure 167: Curiosity Rover



The Phoenix Lander found subsurface ice (Figure 234) that sublimated when exposed to the atmosphere. They can tell it was water by the amount of time it took the ice to disappear.

Figure 168: Phoenix's Ice Sublimation



*Mars is the only planet to which we have sent rovers*

Figure 169: Mars Run-Off Channels

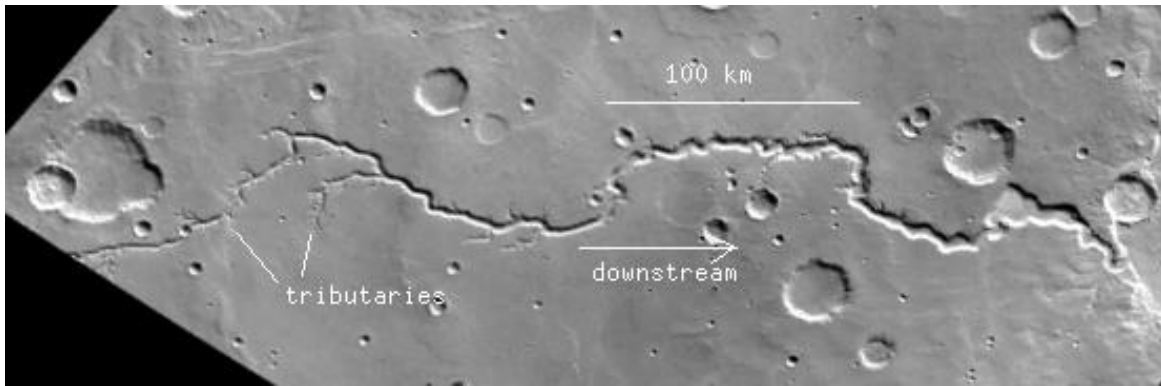


Figure 170: Tear Drop Islands



Figure 171: Deltas

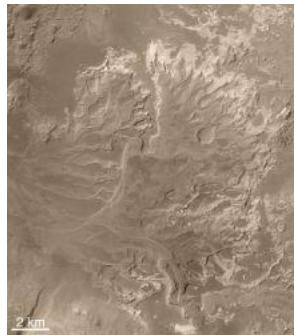
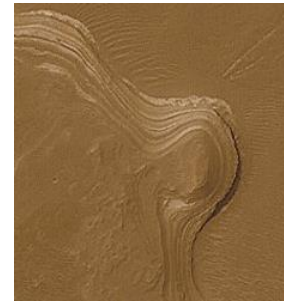


Figure 172: Erosion by Standing Water



## Evidence of Water

Images from orbiters, landers and rovers indicate evidence that there was **water** on Mars in the past. **Runoff channels** (Figure 235), **teardrop islands** (Figure 236), river deltas (Figure 237), and **erosion** by standing water (Figure 238).

In 2015, NASA reported that spectral analysis has revealed that there is now evidence of flowing salty water on the surface of Mars.

*There is evidence of running water that has been found on Mars:*

- *Run-Off Channels*
- *Tear Drop Islands*
- *River Deltas*
- *Evidence of Standing Water*

## Polar Ice Caps

Mars also has **polar ice caps**. The northern ice cap is much larger than the southern one. Much of the material is dry ice (frozen carbon dioxide). There is a large amount of water ice at the southern pole. Both ice caps recede as Mars approaches perihelion, and they begin to grow again after perihelion.

As gases leave the ice caps they form clouds in the atmosphere. Due to winds in the thin atmosphere dust is swept up into the atmosphere as large dust storms. There are times when there is so much dust in the atmosphere that it is impossible to see surface features (Figure 242).

Figure 173: Mars' North Pole

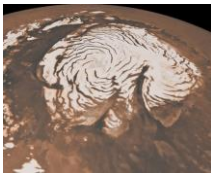


Figure 174: Mars' South Pole

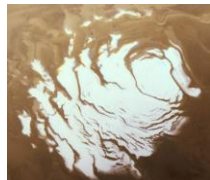


Figure 175: Mar's Ice Cap from Earth

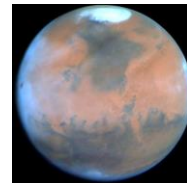
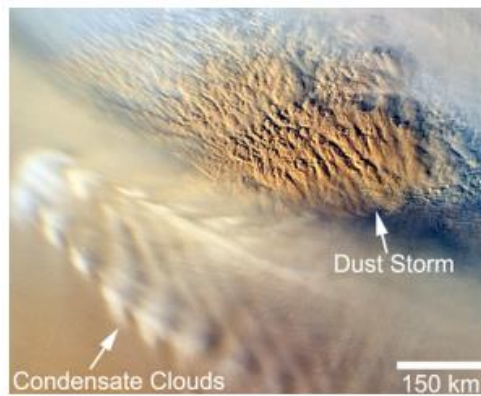


Figure 176: Mars Clouds and Dust Storms





## Component 63 – Mars' Moons

Mars has two moons. The shape and size of the moons implies they are likely captured asteroids that ventured too close to Mars and were captured. They are very small and have tight orbits. They are hard to see in a telescope. Both moons have fairly circular orbits.

### **Phobos**

Phobos is a small oddly shaped moon 11 km across. It orbits Mars at an altitude of 6000 km. Its orbital period is 7 hours and 39 minutes. It is slowly spiraling in to Mars at about 1 meter per century and will eventually impact Mars. It was discovered by Asaph Hall in 1877.

### **Deimos**

Deimos is the smaller and outer moon of Mars. It has a diameter of 6.2 km and is orbiting Mars every 30 hours and 20 minutes at an altitude of 23,463 km. Deimos was also discovered by Asaph Hall in 1877.

Figure 177: Mars' Moon Phobos

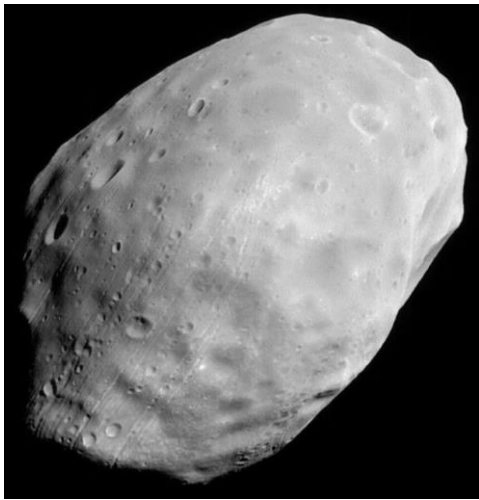


Figure 178: Mars' Moon Deimos



## Component 64 – Jupiter’s Data

### Jupiter

- Mass  $1898.3 \times 10^{24}$  kg (31,783 % Earth)
- Equatorial Radius 71,492 km (1121 % Earth)
- Gravity  $24.8 \text{ m/s}^2$  (253 % Earth)
- Escape Velocity 59.5 km/s (532 % Earth)
- Number of Natural Moons 79
- Rings Yes

*Jupiter is the Largest Planet*

*Jupiter has Four Large Moons: Io, Europa, Ganymede, and Callisto*

### Jupiter’s Orbit

- Semi-Major Axis  $778.6 \times 10^6$  km (520.4 % Earth) 5.2 AU
- Sidereal Orbital Period 4332.6 days (1186.2 % Earth)
- Tropical Orbital Period 4330.6 days (1185.7 % Earth)
- Synodic Period 398.88 days
- Perihelion  $740.52 \times 10^6$  km (503.4 % Earth)
- Aphelion  $816.62 \times 10^6$  km (536.9 % Earth)
- Sidereal Day 9.925 hours (41.5 % Earth)
- Solar Day 9.926 hours (41.4 % Earth)
- Axial Tilt  $3.13^\circ$  (13.4 % Earth)
- Orbital Inclination  $1.304^\circ$
- Apparent Magnitude -2.94 (maximum)
- Apparent Diameter 29.8 to 50.1 arc-seconds

### Jupiter's Magnetosphere

- Field Strength 4.28 gauss-Rh<sup>3</sup>
- Tilt to Axis 9.6 °

*Jupiter has the Largest  
Magnetic Field in the  
Solar System*

### Jupiter's Atmosphere

- Average Temperature 165 K (at 1 bar)
- Composition (very thick atmosphere):
  - Molecular **Hydrogen** 89.8 %
  - **Helium** 8.2 %
  - **Methane** 3000 ppm
  - **Ammonia** 260 ppm
  - Hydrogen Deuteride 28 ppm
  - Ethane 5.8 ppm
  - Water 4 ppm

*Jupiter's atmosphere is  
very similar to a star*

For the latest information on technical data for Jupiter, go to NASA's website:

<http://nssdc.gsfc.nasa.gov/planetary/factsheet/jupiterfact.html>

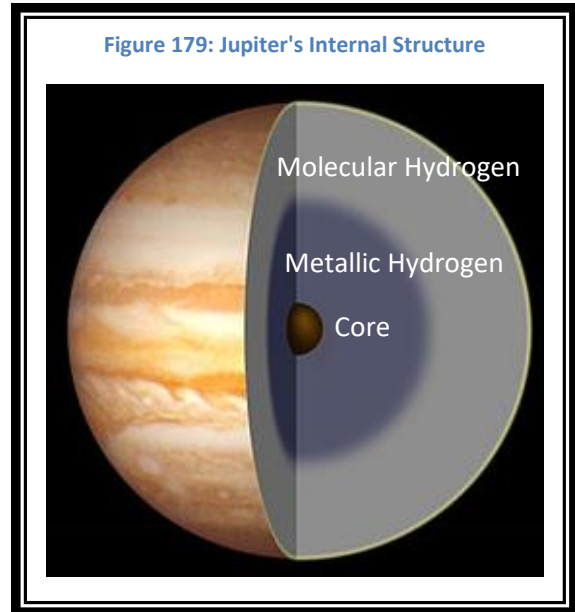
*Jupiter is not massive enough to be a star. It  
would have to be about 80 times larger to have  
enough gravity to provide the pressure and  
temperature in its core necessary for fusion*

## Component 65 – Jupiter’s Structure

Jupiter has an outer shell of clouds followed by a layer of molecular hydrogen and helium, a thick layer of **metallic hydrogen**, and a rocky core.

### The Core

Jupiter’s core, although made of rocky and metallic material is not solid. Because of the extreme pressures and temperatures, the core is likely to be liquid. The core has a radius of approximately 10,000 km. Jupiter is too small to have fusion occurring in its core, but Jupiter does emit more **energy** than it receives from the Sun. This is believed to be due to heat that was generated when the planet condensed to become a planet. This heat of formation continues to radiate into space.



### Metallic Hydrogen

The metallic hydrogen layer is approximately 40,000 km thick. This is a layer of hydrogen that is at a pressure and temperature where the hydrogen acts like a conducting metal. This layer and the core behave as the dynamo that powers Jupiter’s strong magnetic field.

### Molecular Hydrogen

Outside of the metallic hydrogen layer is a thick layer of molecular hydrogen. This layer is approximately 20,000 km thick.

### Outer Cloud Layer

Jupiter has an outer shell of clouds that is visible from Earth. This layer is approximately 100 km thick.

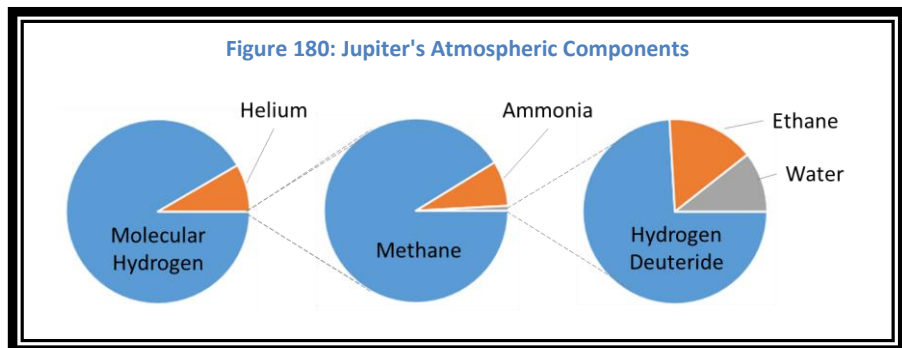
### Jupiter’s Axial Tilt

Jupiter’s axis is tilted only 3 degrees. This means that it is almost perfectly oriented up and down compared to the plane of its orbit.

## Component 66 – Jupiter’s Atmosphere

### Composition

Jupiter has an atmosphere very similar to the atmosphere of the Sun. It is mostly hydrogen and helium, and it is rather thick.



### Surface Markings

The atmosphere has the distinctive markings that we see from Earth. This layer contains the **Zones** and **Belts** that we see circling the planet (Figure 247) as well as storms such as the **Great Red Spot** (Figure 248). The Zones are the brighter bands that contain warmer materials that are upwelling from deeper within Jupiter. The Belts are the darker bands that contain cooler material that is sinking back into the planet. The Great Red Spot is known to be over 300 years old.

Table 15: Jupiter's Atmospheric Composition

Molecular Hydrogen	89.8 %
Helium	8.2 %
Methane	3000 ppm
Ammonia	260 ppm
Hydrogen Deuteride	28 ppm
Ethane	5.8 ppm
Water	4 ppm

Figure 181: Jupiter's Belts and Zones



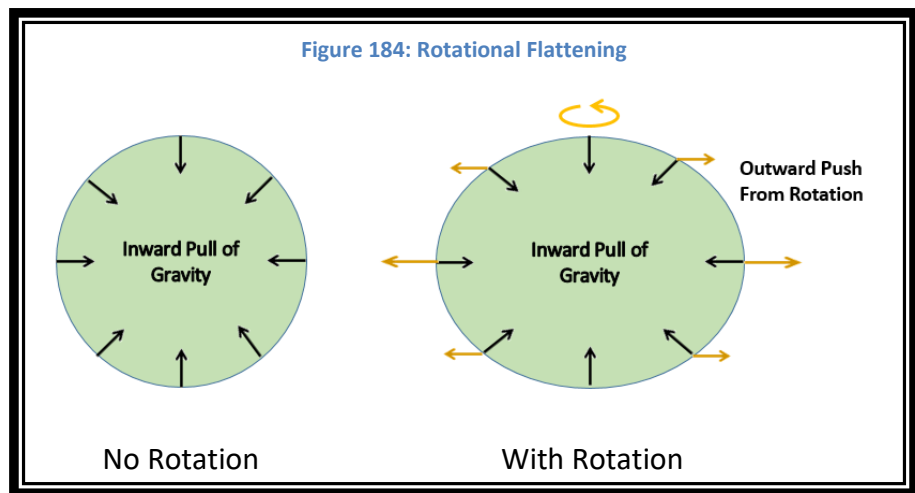
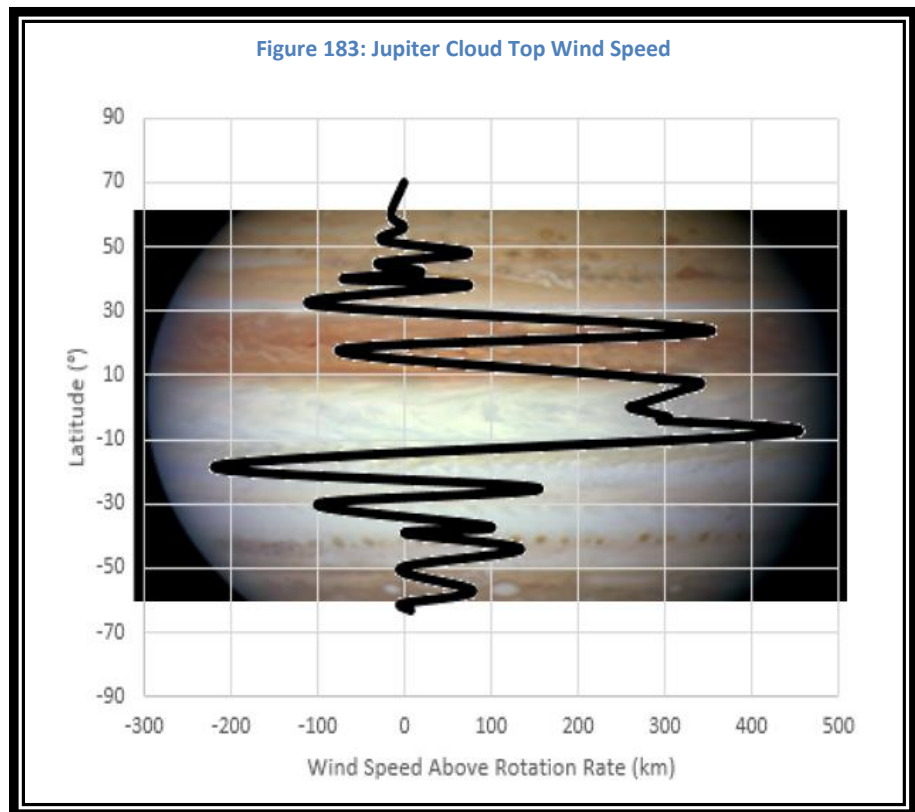
Figure 182: Jupiter's Great Red Spot



**Rotation**

Jupiter, as a gas planet, has different rates of rotation at different latitudes of its atmosphere. This is called **Differential Rotation**. This is not possible in solid planets. Jupiter’s official rotation rate is the rotation of its magnetosphere as measured by radio astronomers. Figure 249 shows the wind speed as it exceeds the speed associated with the rotation rate.

Gas planets also experience Rotational Flattening. The diameter of the planet as measured from pole to pole is less than the diameter measured at the equator. If the planet were not spinning, then gravity would pull the planet into a sphere. But, when the planet is rotating rapidly, there is a significant additional force outward. This force is stronger at the equator and results in an equatorial bulge (see Figure 250). The size of the bulge is related to the material. Gas planets are more strongly flattened than solid planets.

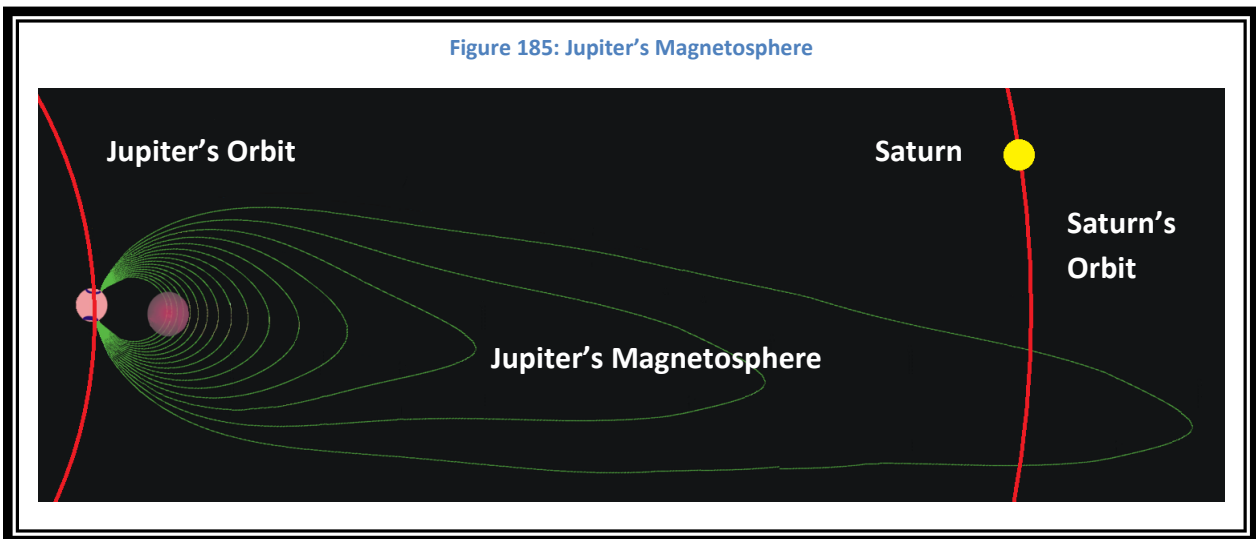


## Component 67 – Jupiter’s Magnetosphere

Jupiter has an intense magnetic field. The field is 20,000 times as strong as the Earth’s magnetic field. In fact the magnetic field is so strong that it extends out beyond the orbit of Saturn. The Pioneer 10 spacecraft as it was flying through the outer planets detected Jupiter’s magnetic field as it crossed the orbit of Saturn. Inside the magnetosphere it detected no solar wind particles.

*Jupiter’s magnetosphere is 20,000 times the strength of the Earth’s*

Figure 185: Jupiter’s Magnetosphere

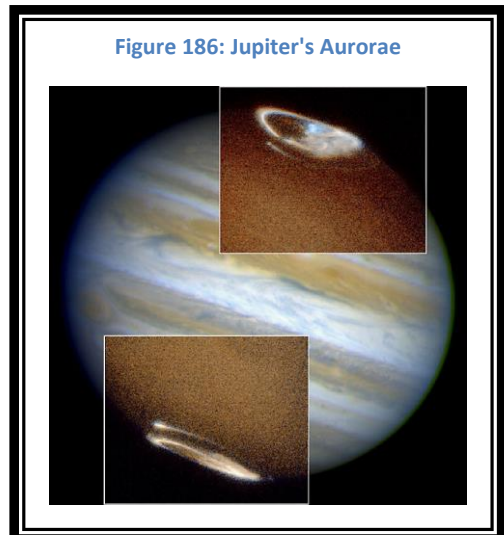


This magnetosphere is caused by the dynamo created by Jupiter’s iron core and the layer of metallic hydrogen surrounding the core. It is tilted 10 degrees from the axis of rotation.

*Jupiter’s magnetosphere extends beyond the orbit of Saturn*

Jupiter has aurorae at the magnetic poles just as the Earth does. These are where charged particles from the solar wind spiral into the atmosphere along the magnetic field lines. Figure 252 shows these aurorae as they are seen in ultraviolet light.

Figure 186: Jupiter's Aurorae



## Component 68 – Jupiter’s Moons

Jupiter has 79 known moons. These range from very large moons that formed as the planets formed to small captured asteroids.

### The Galilean Moons

There are four **Galilean Moons**. These are the four largest and innermost moons. They were discovered by Galileo. These four moons are Io, Europa, Ganymede, and Callisto. The Galilean Moons have roughly circular orbits, they are solid bodies, and lie in Jupiter’s orbital plane. The alignment is so good that we can see the moons pass in front of Jupiter (**Transits** and **Shadow Transits**) and pass behind Jupiter (**Occultations** and **Eclipses**). In fact there are times during Jupiter’s orbit that these moons actually occult each other.

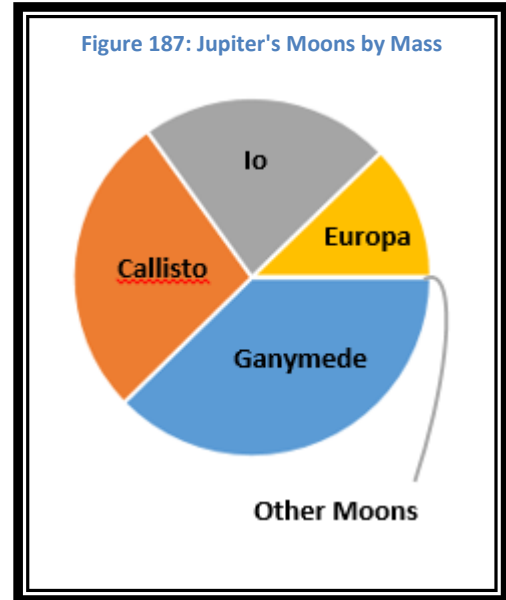


Table 16: The Galilean Moons

Name	Distance (km)	Orbital Period (days)	Diameter (km)
Io	422,000	1.77	3640
Europa	671,000	3.55	3130
Ganymede	1,070,000	7.15	5270
Callisto	1,880,000	16.7	4800

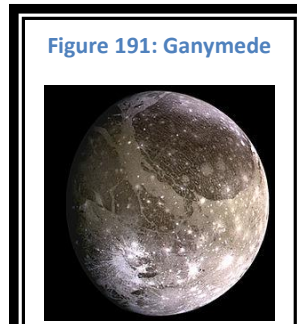
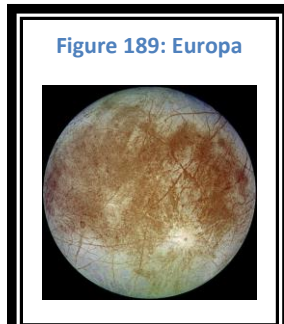
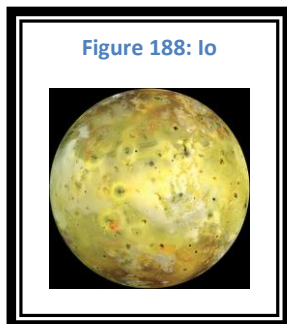
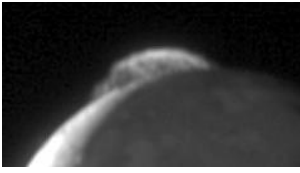




Figure 192: Eruptions on Io



Each of the Galilean Moons has its own distinct personality just like the planets.

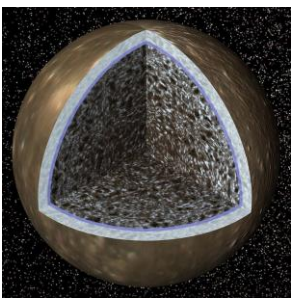
**Io.** Io is the innermost moon. It orbits inside a Plasma Torus inside of Jupiter's strong magnetic field. (A plasma torus is donut shaped

and is filled with charged particles.) This moon is volcanically active. There are **volcanoes** that are spewing forth sulfur into the atmosphere and into the Plasma Torus. Io's interior is shown in Figure 259. It consists of a core of iron and iron sulfide, a mantle similar to the Earth's, and a crust of yellowish sulfur compounds. Io is kept partially molten by strong tidal forces due to the closeness of the planet Jupiter.

**Europa.** Europa is the second of the large moons as you move away from Jupiter. Europa has a frozen ice crust with no signs of cratering. This means that it has a very new crust that is recoated by material from within the moon. Europa's interior has an iron core surrounded by a rocky mantle. This is covered by a possibly liquid salt water **ocean** which is covered by an ice crust.

**Ganymede.** Ganymede is the third Galilean Moon. It too has a differentiated interior. There is a solid iron core surrounded by a liquid iron core. There is then a rocky mantle covered in a layer of ice, liquid salty water, and then a crust of ice.

Figure 196: Callisto's Interior



**Callisto.** Callisto, unlike the other Galilean Moons, appears not to have a differentiated structure. Callisto is the outermost Galilean Moon.

Figure 193: Io's Interior

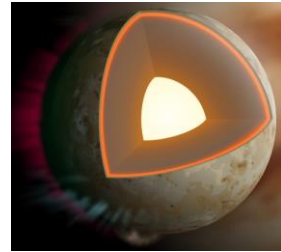


Figure 194: Europa's Interior

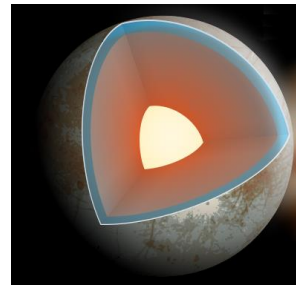
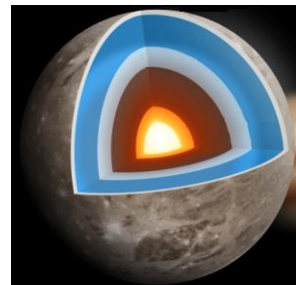


Figure 195: Ganymede's Interior



*Io is volcanically active*

*Europa and Ganymede are thought to have a liquid subsurface salty ocean*



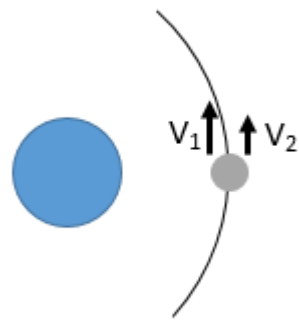
## Component 69 – The Roche Limit

There is a distance from a planet within which the tidal forces are so strong that a moon will be pulled apart. On average, for large gas planets, the **Roche Limit** is equal to 2.4 times the radius of the planet. The actual value will vary slightly depending on the density of the planet and the density of the moon. The 2.4 value is based on the assumptions that the moon and the planet are the same density. Most of the **rings** around the gas giant planets lie within the Roche Limit.

The reason this is a problem for a moon is that the force on one side of the moon is very different from the other side. Based on Kepler's Laws, we know the velocity on the near side ( $V_1$  in Figure 265) will be greater than the velocity on the far side ( $V_2$  in Figure 265). These two different velocities create a force that is trying to tear apart the moon. If the moon is within the Roche Limit, the force will be too strong for the moon to survive.

*The typical Roche Limit is 2.4 times the radius of the planet*

Figure 199: Different Forces

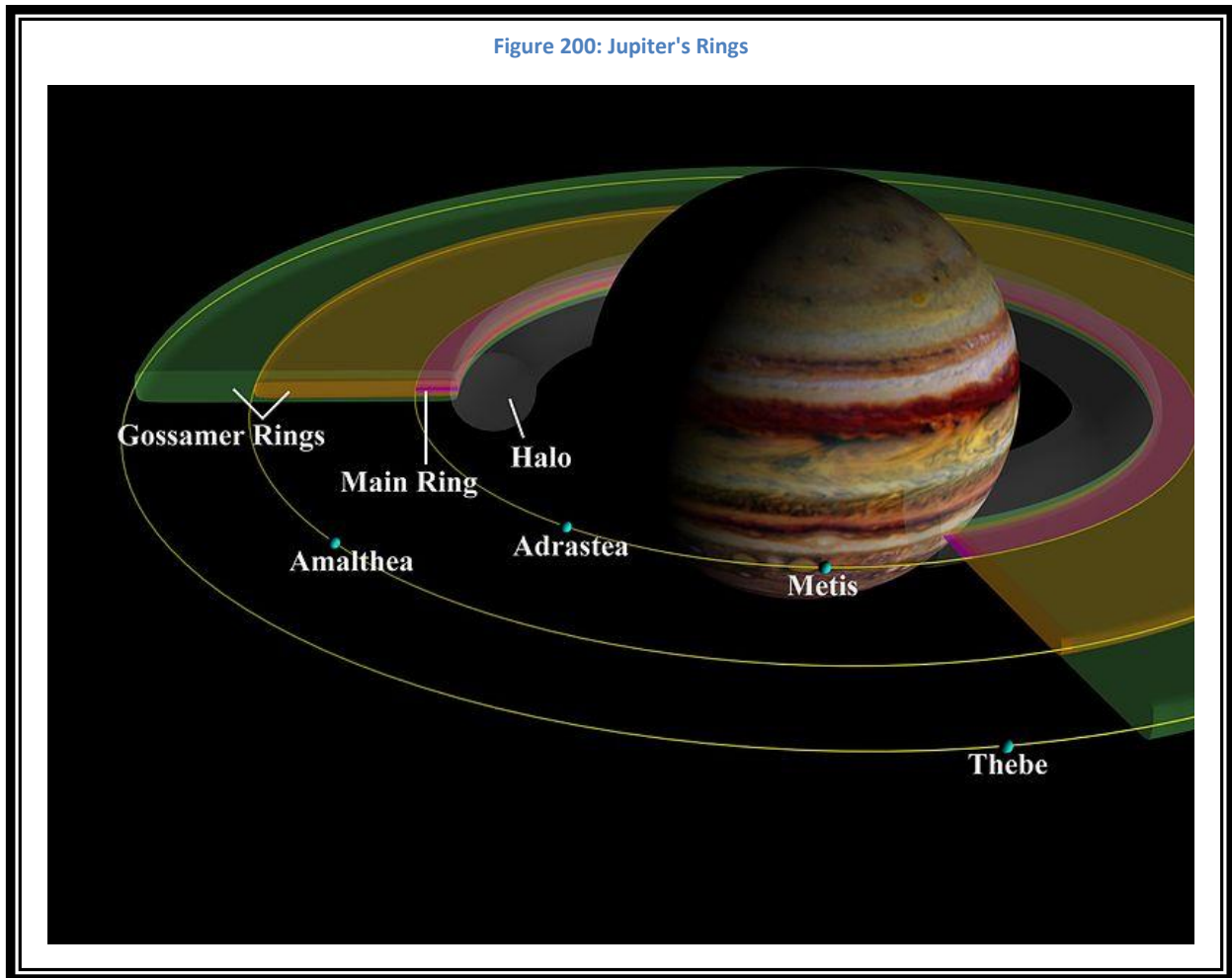


*Planetary rings usually lie within the Roche Limit*

The change in the forces increases as the size of the moon increases. This means that some small moons can survive within the limit and will act as shepherd moons. Shepherd Moons keep the rings clean. As particles move out of the ring, the gravity from the shepherd moons either forces the particle back into the ring, or ejects it from the vicinity.

## Component 70 – Jupiter’s Ring

Jupiter has a ring. It is not observable from Earth and was first discovered by the Voyager 1 spacecraft fly-by. Jupiter has four faint rings mostly composed of dust. The innermost ring is a torus of very fine dust called the Halo Ring. The next ring is the Main Ring and then there are two outer Gossamer Rings (see Figure 266). The rings are aligned with Jupiter’s equator.



The spaces between the rings are the home of small moons. These are called **Shepherd Moons** and keep the particles in the rings in place. Between the Main Ring and the inner Gossamer Ring are the moons Adrastea and Metis. Between the Gossamer Rings is the moon Almathea, and at the outer edge of the outer Gossamer Ring is the moon Thebe.

*Jupiter's rings are not visible from Earth.*

## Component 71 – Saturn’s Data

### Saturn

- Mass  $568.4 \times 10^{24}$  kg (9515.9 % Earth)
- Equatorial Radius 60,268 km (944.9 % Earth)
- Gravity  $10.44 \text{ m/s}^2$  (106.5 % Earth)
- Escape Velocity 35.5 km/s (317.2 % Earth)
- Number of Natural Moons 82
- Rings Yes

*Saturn’s Rings are the only ones visible from Earth*

*Saturn’s Density is so Low it would Float on Water*

### Saturn’s Orbit

- Semi-Major Axis  $1434 \times 10^6$  km (958.2 % Earth) 9.6 AU
- Sidereal Orbital Period 10,759 days (2945.7 % Earth)
- Tropical Orbital Period 10,747 days (2942.4 % Earth)
- Synodic Period 378.09 days
- Perihelion  $1352.6 \times 10^6$  km (919.5 % Earth)
- Aphelion  $1514.5 \times 10^6$  km (995.7 % Earth)
- Sidereal Day 10.66 hours (44.5 % Earth)
- Solar Day 10.66 hours (44.4 % Earth)
- Axial Tilt  $26.73^\circ$  (114 % Earth)
- Orbital Inclination  $2.485^\circ$
- Apparent Magnitude 0.43 (maximum)
- Apparent Diameter 14.5 to 20.1 arc-seconds

### Saturn’s Magnetosphere

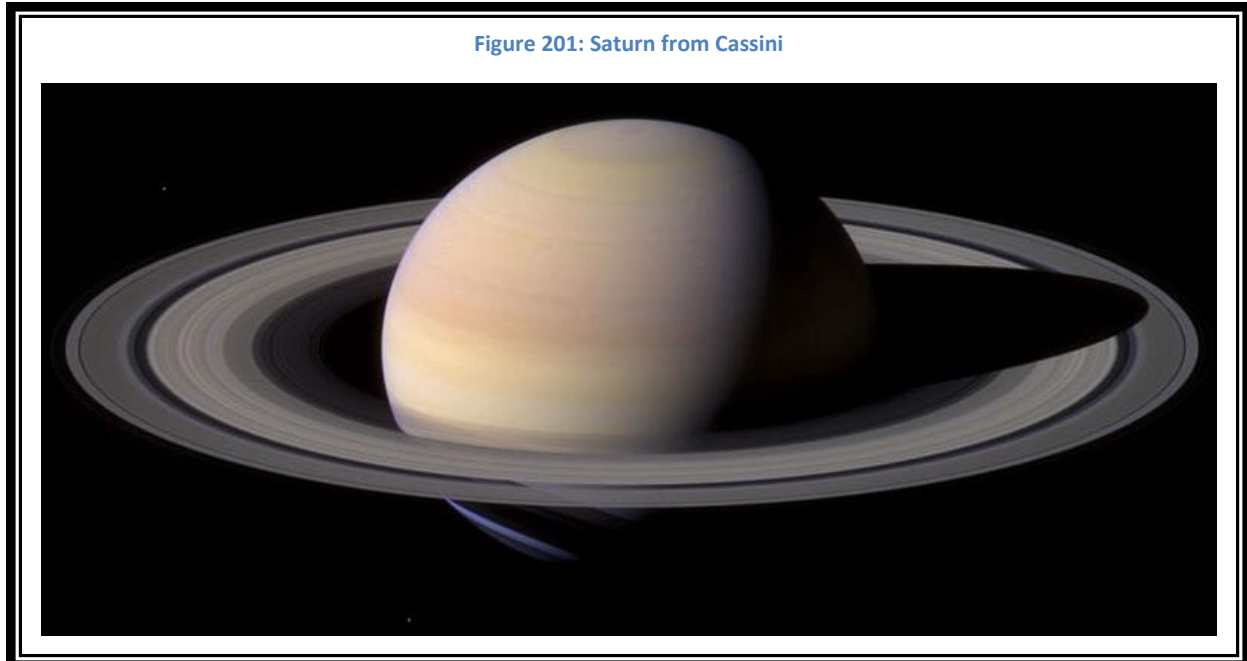
- Field Strength 0.21 gauss-Rh<sup>3</sup>
- Tilt to Axis  $< 1^\circ$

### Saturn's Atmosphere

- Average Temperature      134 K      (at 1 bar)
- Composition (very thick atmosphere):
  - Molecular Hydrogen      96.3 %
  - Helium      3.25 %
  - Methane      4500 ppm
  - Ammonia      125 ppm
  - Hydrogen Deuteride      110 ppm
  - Ethane      7 ppm

*Saturn's Atmosphere is very Similar to a Star but  
note that its Helium is about 1/3 that of Jupiter*

For the latest information on technical data for Saturn, go to NASA's website:



<http://nssdc.gsfc.nasa.gov/planetary/factsheet/saturnfact.html>

## Component 72 – Saturn's Structure

Saturn has an outer shell of clouds followed by a layer of molecular hydrogen and helium, a layer of metallic hydrogen, and a rocky core.

### **The Core**

Saturn's core, although made of rocky and metallic material is not solid. Because of the extreme pressures and temperatures, the core is likely to be liquid. The core has a radius of approximately 15,000 km. Saturn emits more energy than it receives from the sun. It is believed that in the past helium condensed in the upper atmosphere and dropped towards the center of Saturn as **helium**

**rain**. As it did this, the increased pressures would cause the drops to heat up. This heat is then radiated outward from the planet.

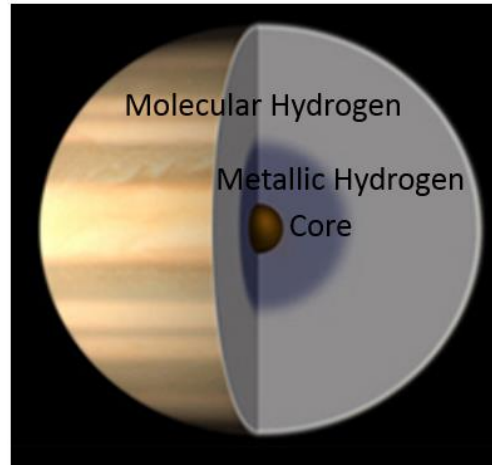
### **Metallic Hydrogen**

The metallic hydrogen layer is approximately 15,000 km thick. This is a layer of hydrogen that is at a pressure and temperature where the hydrogen acts like a conducting metal. This layer and the core behave in the same way as the dynamo that powers Jupiter's strong magnetic field.

### **Molecular Hydrogen**

Outside of the metallic hydrogen layer is a thick layer of molecular hydrogen. This layer is approximately 30,000 km thick.

Figure 202: Saturn's Internal Structure



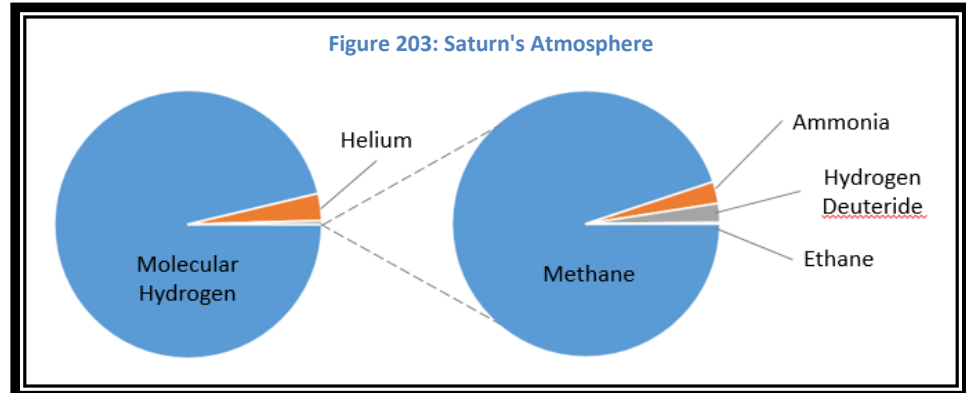
*Saturn emits more energy than it receives from the sun. This is due to helium droplets falling towards the center in the past*

*Saturn's Upper Clouds are so thick we don't see the strong markings that we see on Jupiter*

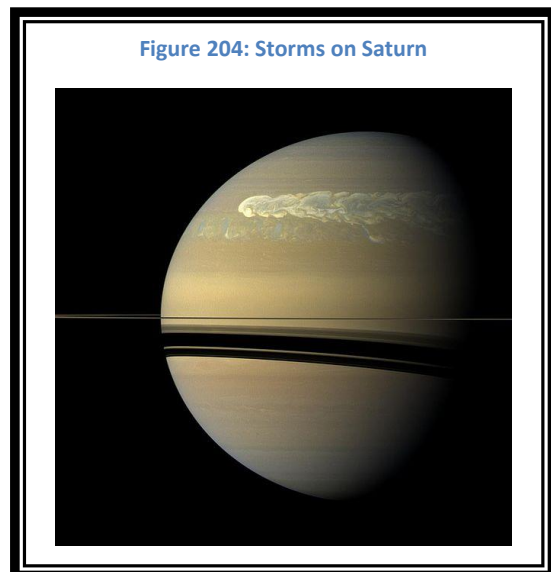
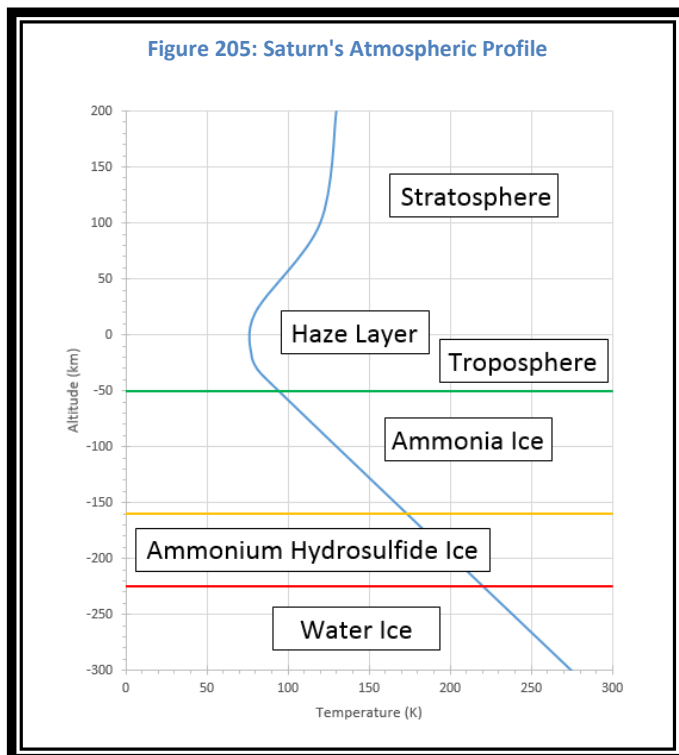
## Component 73 – Saturn’s Atmosphere

### Composition

Saturn’s atmosphere is mostly composed of molecular hydrogen (96%) and Helium (3%).



### Atmospheric Structure



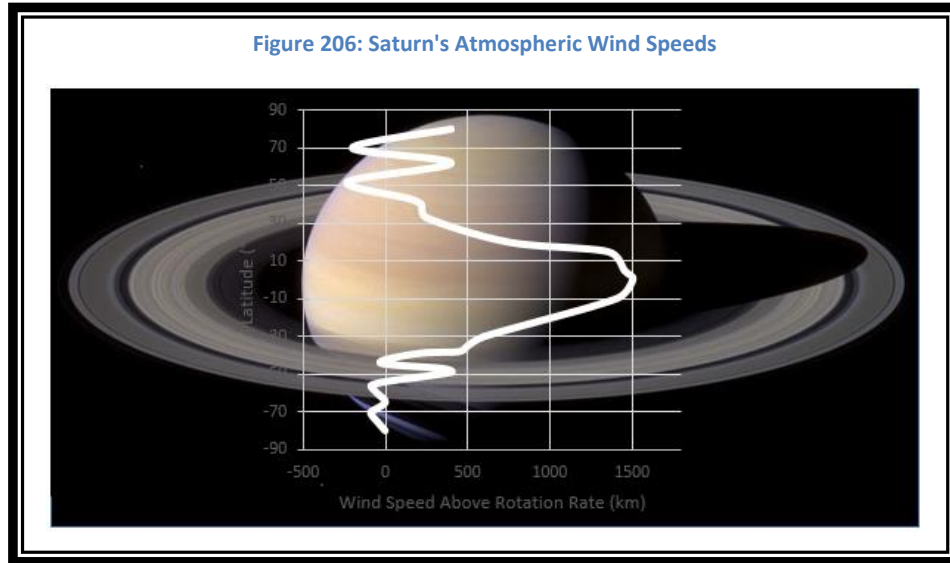
Saturn’s lower atmosphere, the Troposphere, consists of layers of ice. **Water Ice** is the bottom layer from -300 km to approximately -225 km. Then there is a layer of **ammonium hydrosulfide ice** up to approximately -

160 km. And the top layer of ice is **ammonia ice** up to approximately -50 km. At 0 km there is a thick cloud layer. This haze layer is visible from Earth. Storms can be seen on Saturn’s surface, but the **thick upper layer** of clouds makes markings much less obvious than on Jupiter (see Figure 270). Saturn’s Stratosphere continues upwards from the haze layer.



### **Saturn's Wind Speeds**

Although the swings in the velocities of Saturn's atmospheric bands are not as dramatic as they are on Jupiter, the equatorial speed is significantly greater.



## Component 74 – Saturn’s Magnetosphere

Saturn has a very strong magnetosphere, but not nearly as strong as Jupiter’s. The most obvious effect of the magnetosphere is the **aurorae** seen near Saturn’s magnetic poles.

The magnetosphere reaches approximately 1 million km towards the Sun. This includes Saturn’s rings and many of its small inner moons. Titan orbits on the edge of the magnetosphere. Unlike Jupiter, there is no plasma torus.

Saturn’s magnetic field is closely aligned with its axis of rotation. Both are tilted at an angle of approximately 28 degrees.

Figure 207: Aurorae on Saturn

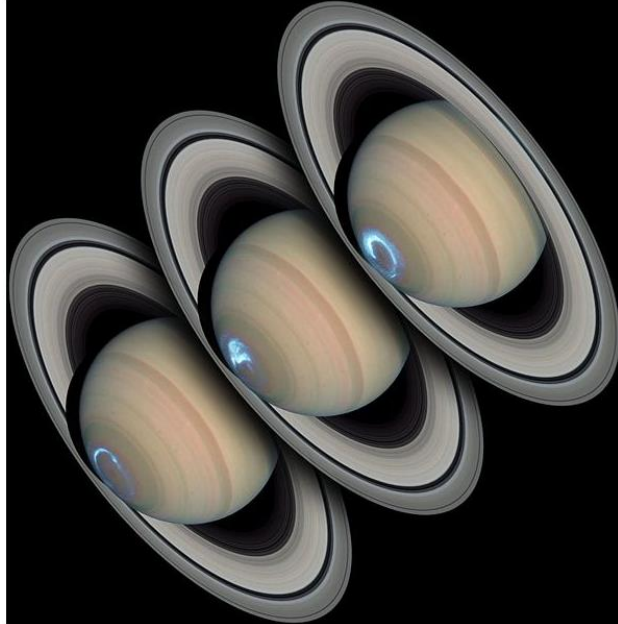
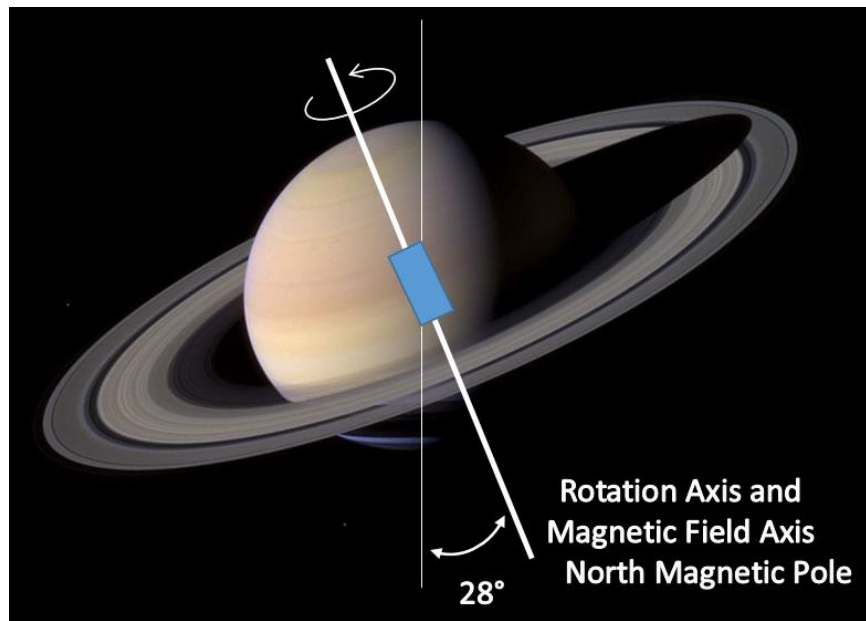


Figure 208: Saturn's Magnetic Field



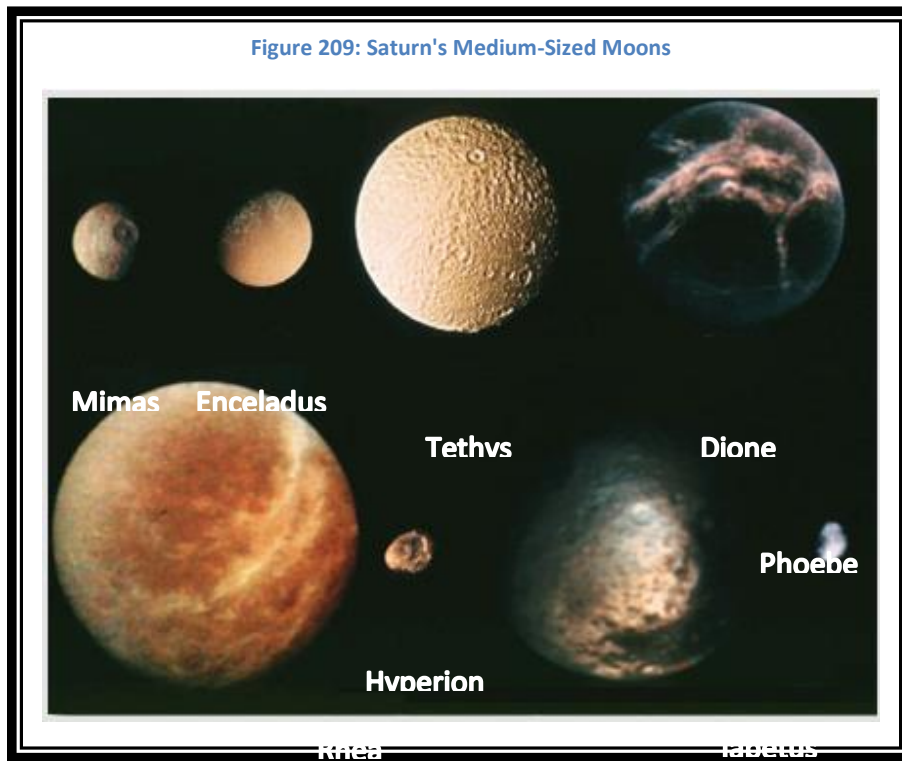
## Component 75 – Saturn’s Moons

Saturn has more known moons than Jupiter. Saturn has 82 known moons. They range in size from small apparently captured asteroids and Kuiper Belt objects to the giant moon Titan. There are also 7 medium sized moons. These seven and Titan can be seen in modest telescopes from Earth.

### Saturn’s Major Moons

**Table 17: Saturn's Major Moons**

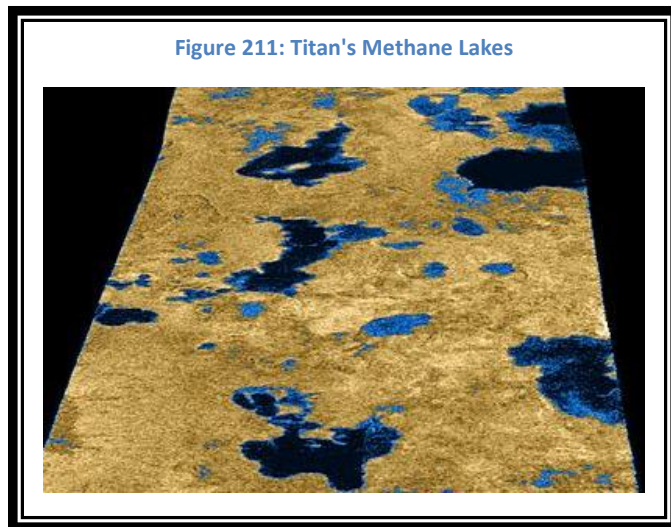
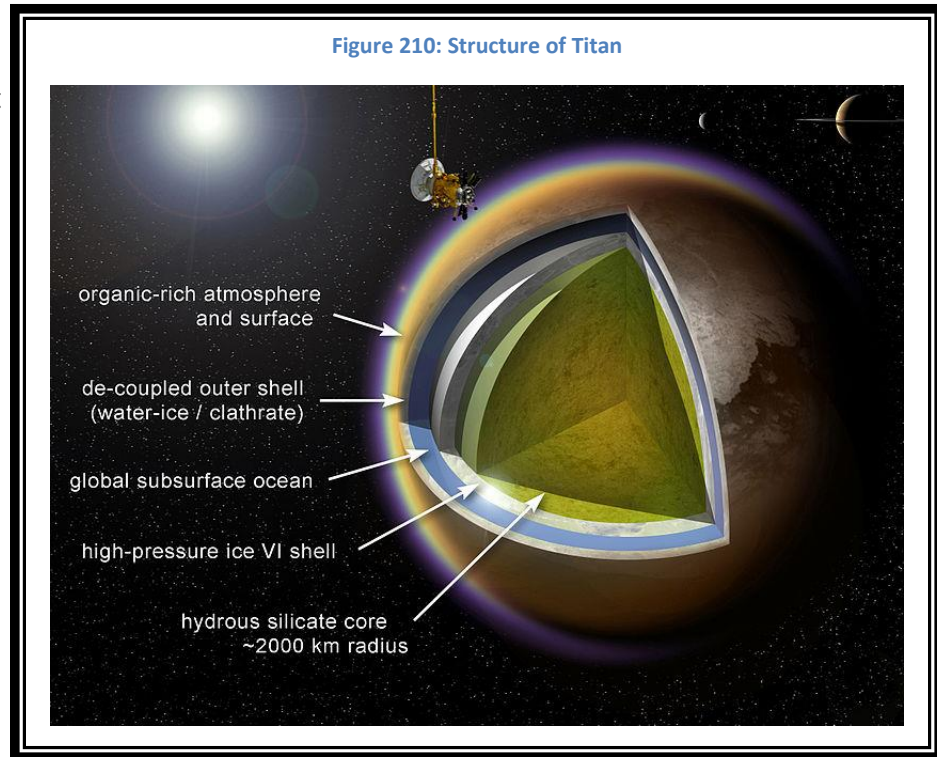
Name	Distance (km)	Orbital Period (days)	Diameter (km)
<b>Mimas</b>	186,000	0.94	398
<b>Enceladus</b>	238,000	1.37	498
Tethys	295,000	1.89	1060
Dione	377,000	2.74	1120
Rhea	527,000	4.52	1530
<b>Titan</b>	1,220,000	16	5150
Hyperion	1,480,000	21.3	370
Iapetus	3,560,000	79.3	1440



## Titan

Titan is Saturn's largest moon. It was discovered by Christian Huygens in 1655. It is larger than the planet Mercury. It has a thick atmosphere and has been investigated thoroughly by the Cassini Mission. Cassini dropped the Huygens Probe into Titan's atmosphere where it parachuted to the surface. It is

believed that like two of Jupiter's moons, Titan may also have a subsurface salty liquid water ocean. Titan's temperature is so cold that there are liquid **methane lakes** (Figure 277) on its boulder strewn surface (Figure 278).

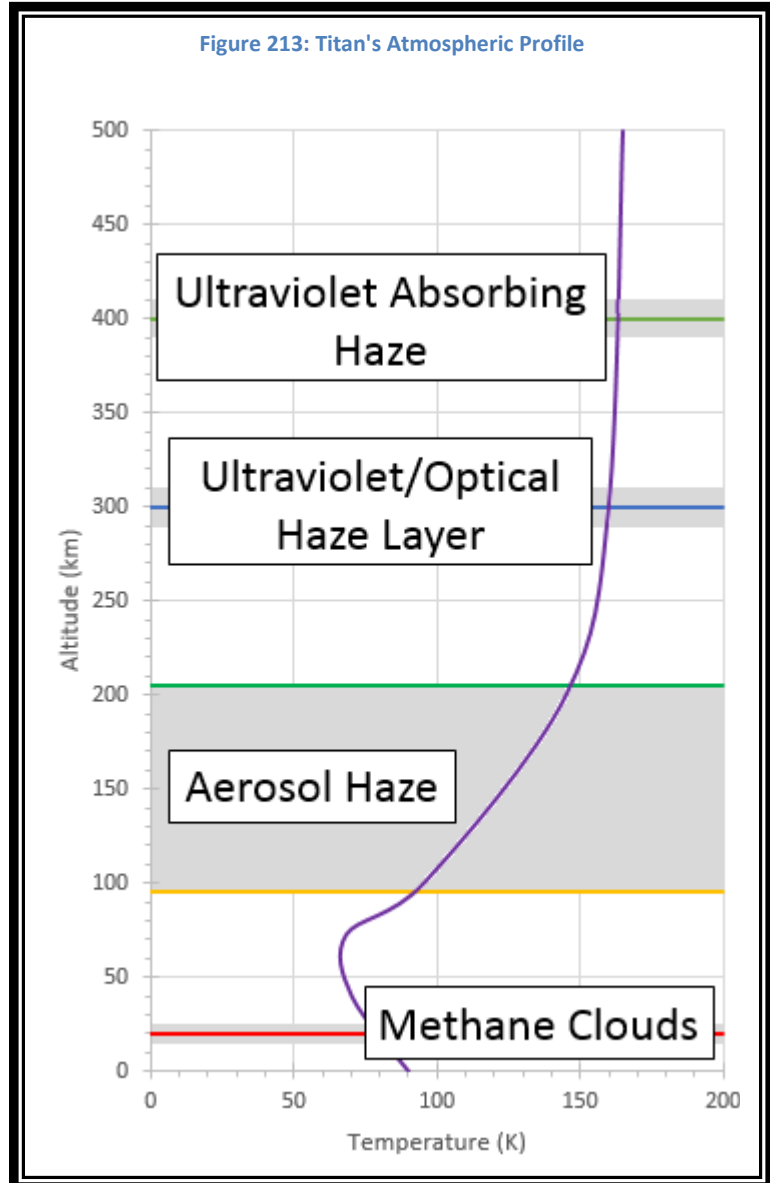
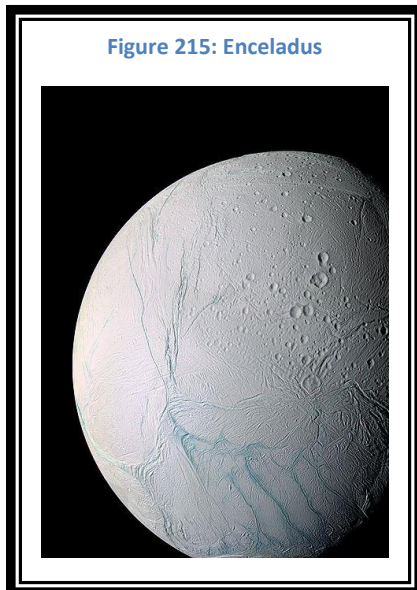
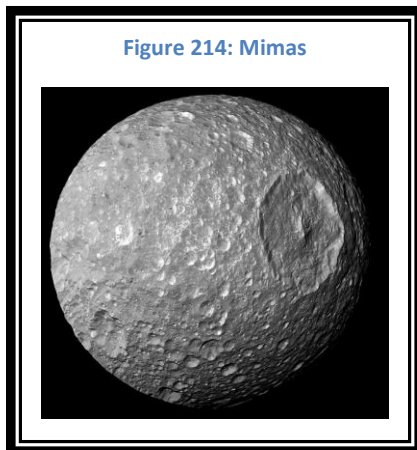


*Titan is larger than Mercury*

*Titan has lakes of liquid Methane*

Titan's atmosphere has many layers of haze. There is methane rain falling from the lowest level of methane clouds (Figure 279).

Each of Saturn's moons has its own character. Mimas (Figure 281) resembles the Death Star from Star Wars. Enceladus has a very new surface of cracked ice (Figure 281).



Saturn also has moons that share orbits:

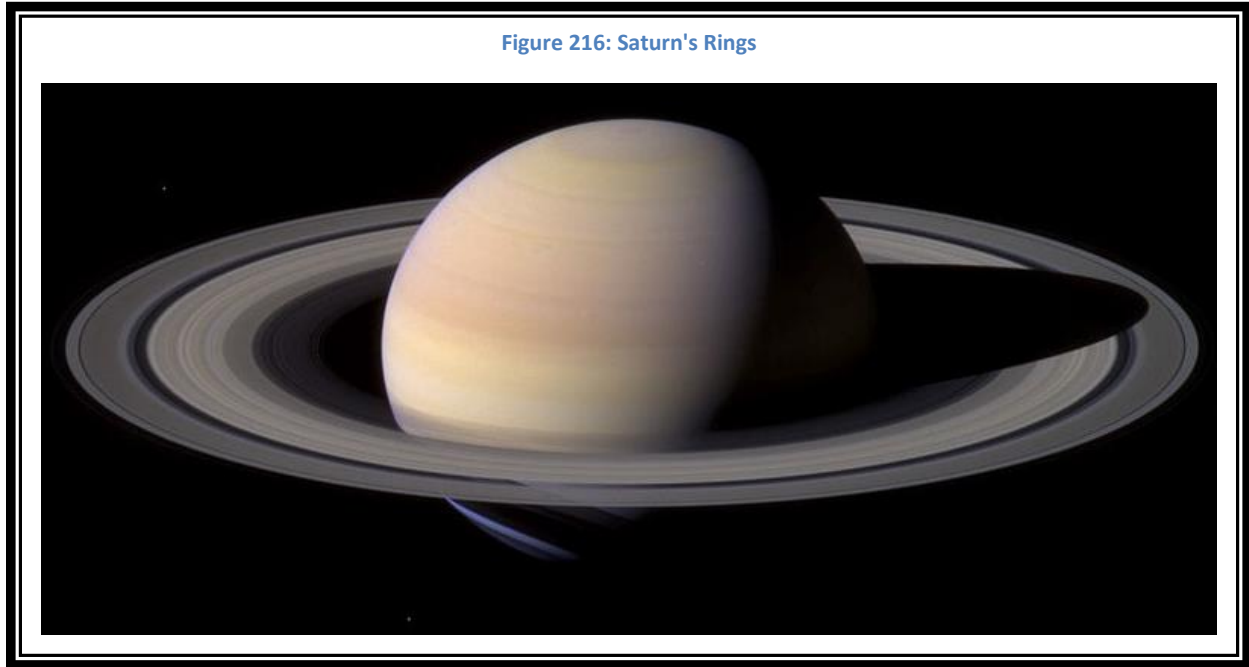
Tethys has the moon Telesto in its forward Lagrangian Point, and the moon Calypso in its rear Lagrangian Point.

Dione has the moon Helene in its forward Lagrangian Point, and the moon Polydeuces in its rear Lagrangian Point.

The moons Janus and Epimetheus, orbiting just outside of Saturn's rings swap orbits when they pass each other.

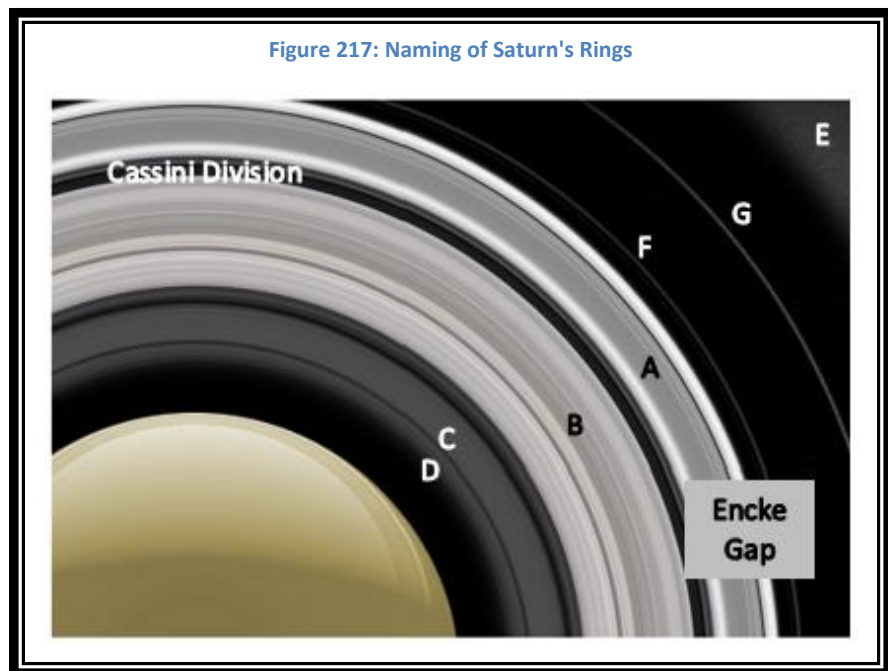
## Component 76 – Saturn's Rings

Saturn has the most magnificent **rings** in the solar system. It is the only planet whose rings can be seen from Earth. The rings are composed of many small icy pieces, but there is much open



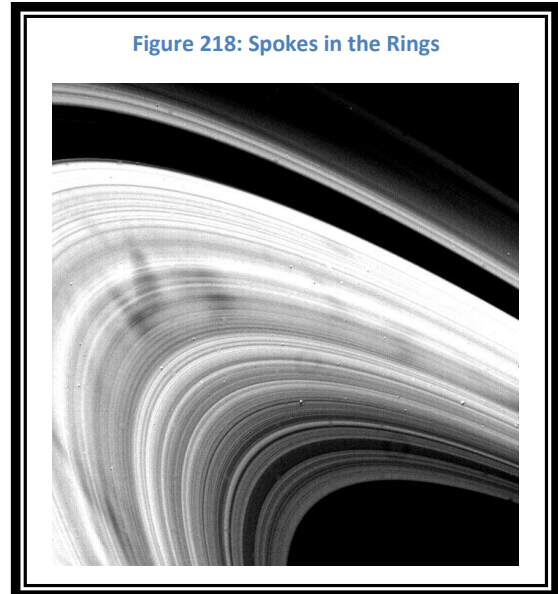
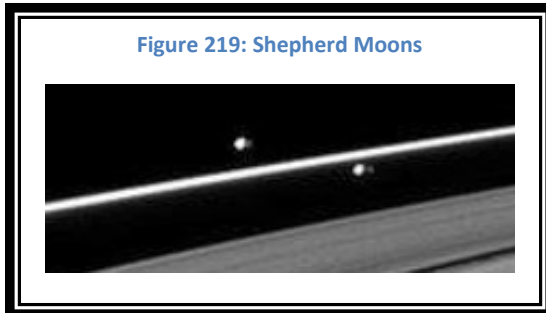
space between them. The Cassini spacecraft has passed through the rings multiple times with no collisions. The rings are named in the order in which they were discovered: A through G.

There is a large split between the A and B rings called the **Cassini Division** and a smaller gap near the outer edge of the A ring called the **Encke Gap**. The E ring is large and faint. Although the gaps appear empty, they do have particles in them, but at a lower concentration than the brighter rings.



They have also discovered **spokes** radiating outward across the rings. Their origin is not yet known (Figure 284).

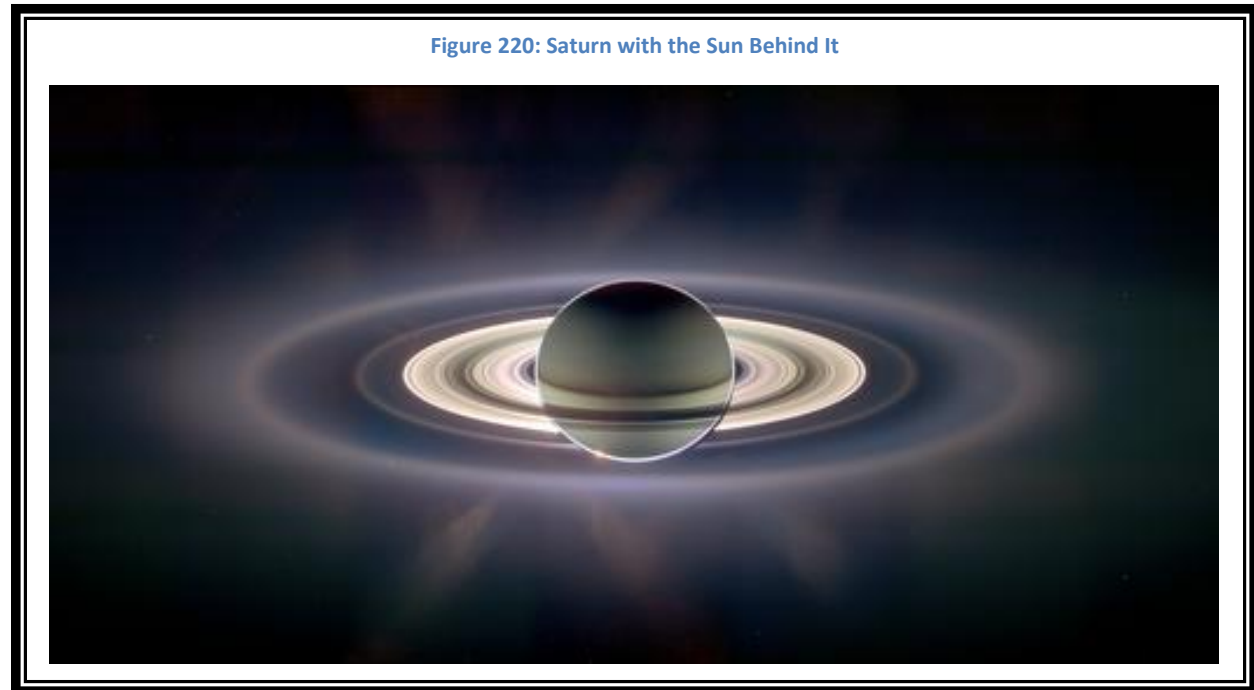
Amongst the rings are **shepherd moons**. The gravity of these small moons pushes and pulls on ring particles that migrate away from the rings. They are either pushed back into the ring or expelled (Figure 285).



All of Saturn's rings are within its Roche Limit.

*Saturn's Rings are made of many small icy particles*

*Saturn's Rings are the only ones visible from Earth*



## Component 77 – Lagrangian Objects

There are many objects in the solar system that reside in **Lagrangian Points** of other objects. There are **five** stable gravitational points in any two body system. They are numbered L1 through L5. Most commonly these objects are moons or asteroids that are in the L4 (**ahead**) and L5 (**behind**) Points of planets, moons, or asteroids.

### Sun – Earth System

- L4 – asteroid 2010 LK7
- L5 – asteroid 2010 SO16

### Sun – Mars System

- L4 – asteroid 1997 UJ7
- L5:
  - asteroid 5261 Eureka
  - asteroid 1998 VF31
  - asteroid (311999) 2007 NS2
  - asteroid (385250) 2001 DH47

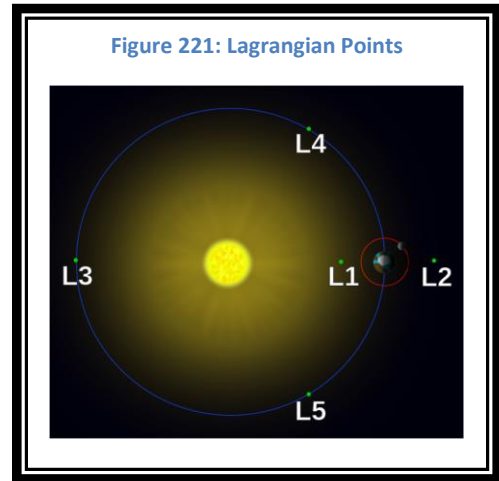
### Sun – Jupiter System

- There are 561 Trojan asteroids in Jupiter's L4 Point.
- There are 376 Trojan asteroids in Jupiter's L5 Point.

### Saturn – Tethys System

- L4 – moon Telesto
- L5 – moon Calypso

We also put spacecraft at Lagrangian Points to use them as a stable locations requiring little fuel to remain in place.



### Saturn – Dione System

- L4 – moon Helene
- L5 – moon Polydeuces

### Sun – Uranus System

- L4 – asteroid 2011QF99

### Sun – Neptune System

- There are 6 asteroids in Neptune's L4 Point
- There are 3 asteroids in Neptune's L5 Point.



## Component 78 – Uranus' Data

### Uranus

- Mass  $86.82 \times 10^{24}$  kg (1453.6 % Earth)
- Equatorial Radius 25,559 km (400.7 % Earth)
- Gravity  $8.87 \text{ m/s}^2$  (90.5 % Earth)
- Escape Velocity 21.3 km/s (190.3 % Earth)
- Number of Natural Moons 27
- Rings Yes

### Uranus' Orbit

- Semi-Major Axis  $2872.5 \times 10^6$  km (1920 % Earth) 19.2 AU
- Sidereal Orbital Period 30,685 days (8401 % Earth)
- Tropical Orbital Period 30,589 days (8375 % Earth)
- Synodic Period 369.66 days
- Perihelion  $2741.3 \times 10^6$  km (1864 % Earth)
- Aphelion  $3003.62 \times 10^6$  km (1975 % Earth)
- Sidereal Day 17.24 hours (72 % Earth)
- Solar Day 17.24 hours (72 % Earth)
- Axial Tilt  $97.77^\circ$  (417 % Earth)
- Orbital Inclination  $0.772^\circ$
- Apparent Magnitude 5.32 (maximum)
- Apparent Diameter 3.3 to 4.1 arc-seconds

### Uranus' Magnetosphere

- Field Strength  $0.23 \text{ gauss-Rh}^3$  • Magnetic field is off axis
- Tilt to Axis  $58.6^\circ$

### Uranus' Atmosphere

- Average Temperature 76 K (at 1 bar)
- Composition (thick atmosphere):
  - Molecular **Hydrogen** 82.5 % ○ **Methane** 2.3 %
  - **Helium** 15.2 % ○ **Hydrogen Deuteride** 148 ppm

For the latest information on technical data for Uranus, go to NASA's website:

<http://nssdc.gsfc.nasa.gov/planetary/factsheet/uranusfact.html>

## Component 79 – Uranus' Structure

### Uranus' Internal Structure

Uranus has a rocky/icy core surrounded by a mantle of water, ammonia, and methane ices. There is an envelope of hydrogen, helium, and methane gas surrounding this. The radius of the core is approximately 5,100 km. The thickness of the mantle is approximately 15,200 km and the thickness of the outer layer is approximately 5,100 km.

### Uranus' Axial Tilt

At some point in the early days of the solar system it is likely that Uranus had a major collision with a large body. As a result of that collision, Uranus' rotational axis is significantly tilted compared to most objects in the solar system. Its **Rotation Axis** is tilted 98 degrees. This is essentially lying in the plane of the solar system, but since it is past 90 degrees, Uranus has a **retrograde** rotation.

*Uranus' Rotational Axis  
is tilted at 98 degrees*

Figure 222: Uranus' Internal Structure

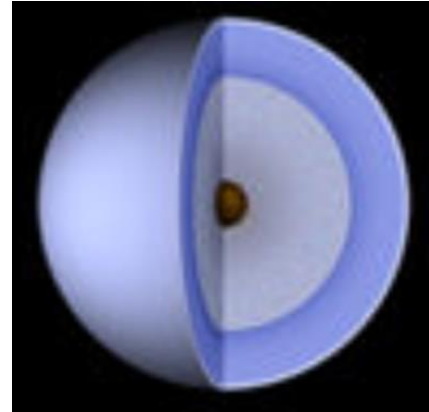
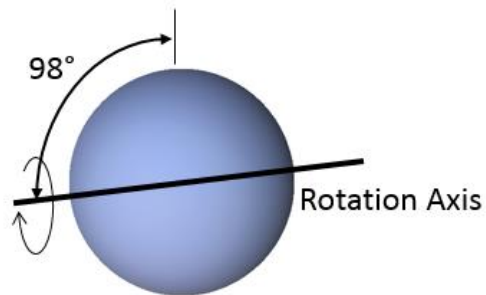
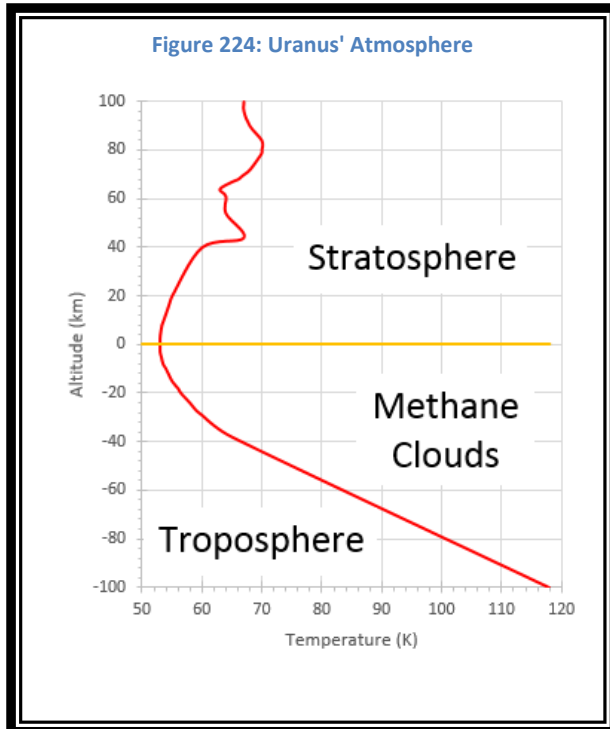


Figure 223: Uranus' Axial Tilt



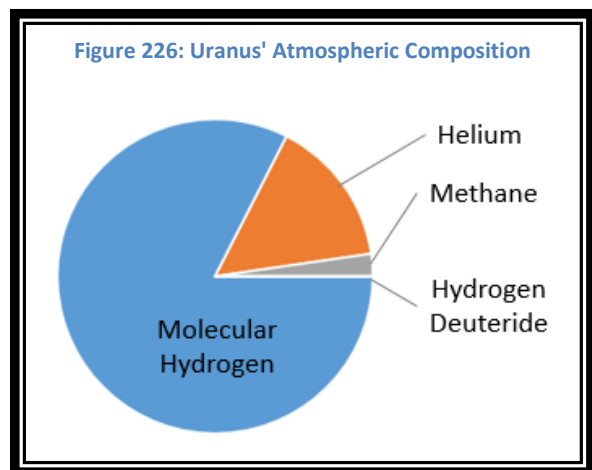
Unlike the other giant planets of the solar system, Uranus does not radiate more energy than it receives from the sun.

## Component 80 – Uranus' Atmosphere

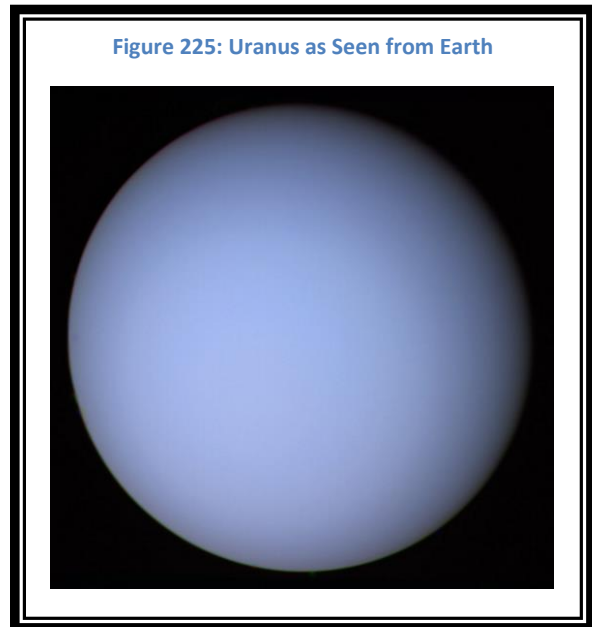


### Composition

Uranus' atmosphere has a thick layer of methane clouds in the troposphere. Uranus is a **green-blue color** and this is largely due to the methane in the atmosphere. Methane absorbs red and yellow light so only the bluer colors are reflected back into space.

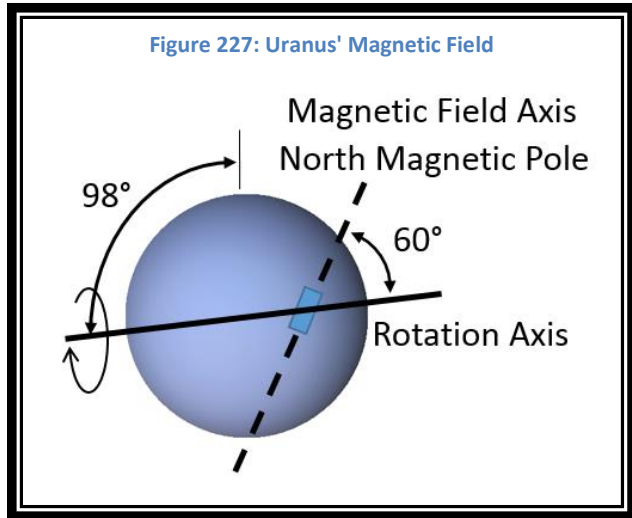


Due to haze in the stratosphere, the details of Uranus' cloud tops are not visible from Earth. Uranus' outer atmosphere is very similar to Jupiter's. It is mostly molecular hydrogen with some helium and methane. Unlike Jupiter, there is very little ammonia.



*Methane in Uranus' atmosphere makes it appear green-blue*

## Component 81 – Uranus' Magnetosphere



In addition to Uranus being tilted on its side, its **magnetic field** is **off center**. Its center is located below the equator. Additionally it is 60 degrees **off axis** from the axis of rotation. Scientists are not sure of the reason for it being off-center.

*Uranus' Magnetic Field is Off Center and has a Significant Difference from the Rotational Axis*

## Component 82 – Uranus' Moons

Table 18: Uranus' Major Moons

Name	Distance (km)	Orbital Period (days)	Diameter (km)
Miranda	130,000	1.41	480
Ariel	191,000	2.52	1160
Umbriel	266,000	4.14	1170
Titania	436,000	8.71	1580
Oberon	583,000	13.5	1520

Figure 228: Uranus' Moons



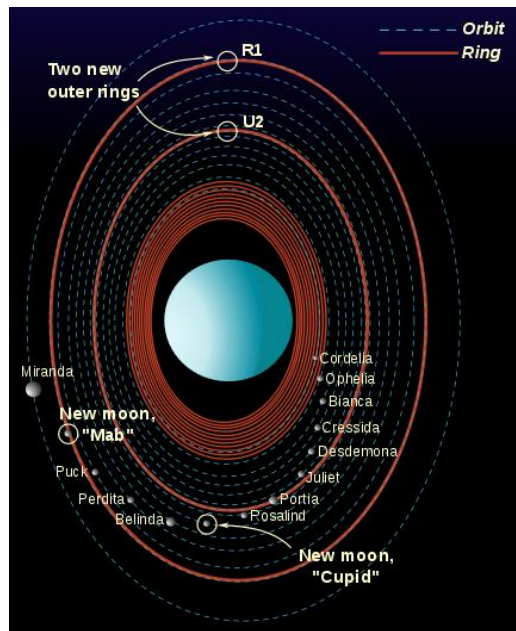
Uranus has 27 known moons. Five moons are rather large:

- Miranda
- Ariel
- Umbriel
- Titania
- Oberon

The four largest moons can be seen from Earth in larger telescopes.

Uranus' two innermost moons, Cordelia and Ophelia, are shepherd moons to the Epsilon Ring.

Figure 229: Moon Orbits and Rings



## Component 83 – Uranus’ Rings

Uranus’ **13** rings are not visible from Earth, but they can be detected as stars are occulted by Uranus. Stars appear to disappear and reappear just before and just after the stars are occulted by the planet. Like most ring systems there are shepherd moons to keep the rings tidy.

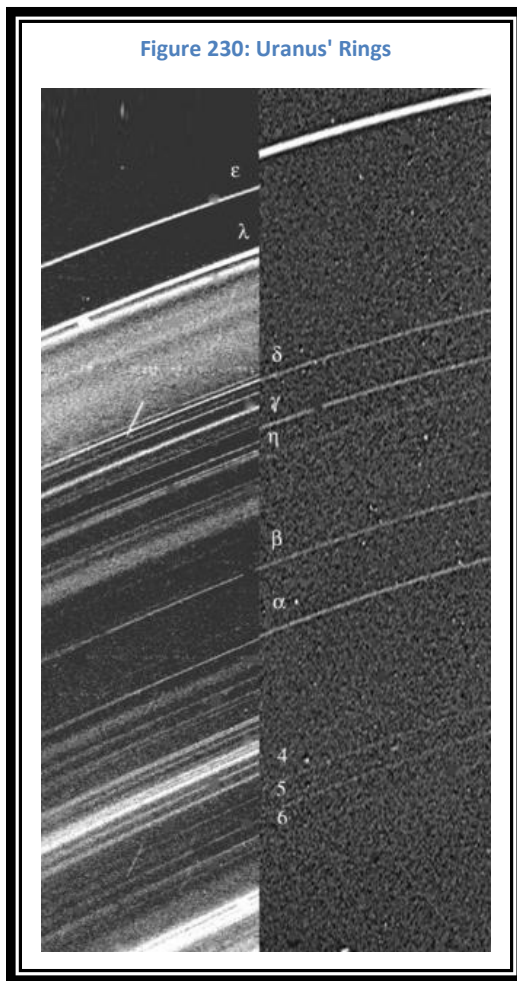


Table 19: Uranus' Rings

Name	Inner Radius (km)	Width (km)
1986U2R	37,000	2500
6	41,800	2
5	42,200	2
4	42,600	3
Alpha	44,700	4-10
Beta	45,700	5-11
Eta	47,200	2
Gamma	47,600	1-4
Delta	48,300	3-7
1986U1R	50,000	2
Epsilon	51,200	20-100

In addition to the rings in Table 19 and those shown in Figure 296, there are two outer rings that were discovered in 2003-2005 by the Hubble Telescope.

Figure 296 shows what the moons appear like with sunlight that has been backscattered (left side) and forward scattered (right side).

*Uranus has a total of 13 known rings*

## Component 84 – Neptune’s Data

### Neptune

- Mass 102.42 x 10<sup>24</sup> kg (1714.7 % Earth)
- Equatorial Radius 24,764 km (388.3 % Earth)
- Gravity 11.15 m/s<sup>2</sup> (114 % Earth)
- Escape Velocity 23.5 km/s (210 % Earth)
- Number of Natural Moons 14
- Rings Yes

### Neptune’s Orbit

- Semi-Major Axis 4495 x 10<sup>6</sup> km (3005 % Earth) 30.0 AU
- Sidereal Orbital Period 60,189 days (16479 % Earth)
- Tropical Orbital Period 59,780 days (16373 % Earth)
- Synodic Period 367.49 days
- Perihelion 4444.5 x 10<sup>6</sup> km (3022 % Earth)
- Aphelion 4545.7 x 10<sup>6</sup> km (2989 % Earth)
- Sidereal Day 16.11 hours (67.3 % Earth)
- Solar Day 16.11 hours (67.1 % Earth)
- Axial Tilt 28.32 ° (120.8 % Earth)
- Orbital Inclination 1.769 °
- Apparent Magnitude 7.78 (maximum)
- Apparent Diameter 2.2 to 2.4 arc-seconds

### Neptune’s Magnetosphere

- Field Strength 0.142 gauss-Rh<sup>3</sup>
- Tilt to Axis 46.9 °
- Magnetic field is off axis

*Neptune’s Magnetic  
Field is off-center  
and has a significant  
offset from the  
Rotational Axis*

### **Neptune's Atmosphere**

- Average Temperature      72 K                      (at 1 bar)
- Composition (thick atmosphere):
  - Molecular Hydrogen    80.0 %                      ○ Hydrogen Deuteride    192 ppm
  - Helium                      19.0 %                      ○ Ethane                      1.5 ppm
  - Methane                    1.5 %

For the latest information on technical data for Neptune, go to NASA's website:

**<http://nssdc.gsfc.nasa.gov/planetary/factsheet/neptunefact.html>**



## Component 85 – Neptune's Structure

### Neptune's Internal Structure

Neptune has a rocky/icy core surrounded by a mantle of water, ammonia, and methane ices. There is an envelope of hydrogen, helium, and methane gas surrounding this. The radius of the core is approximately 10,000 km. The thickness of the mantle is approximately 10,000 km and the thickness of the outer layer is approximately 5,000 km.

Neptune emits more **energy** than it receives from the Sun, similar to Saturn and Jupiter. The cause of this excess radiation from Neptune is not known.

Figure 231: Neptune's Internal Structure

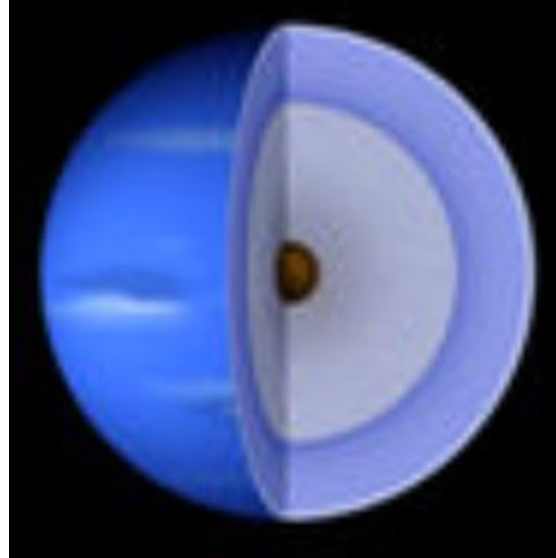
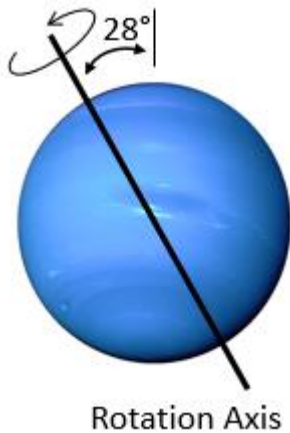


Figure 232: Neptune's Axis of Rotation



### Neptune's Axial Tilt

Neptune's rotational axis is tilted 28 degrees. This is not much different from Earth's.

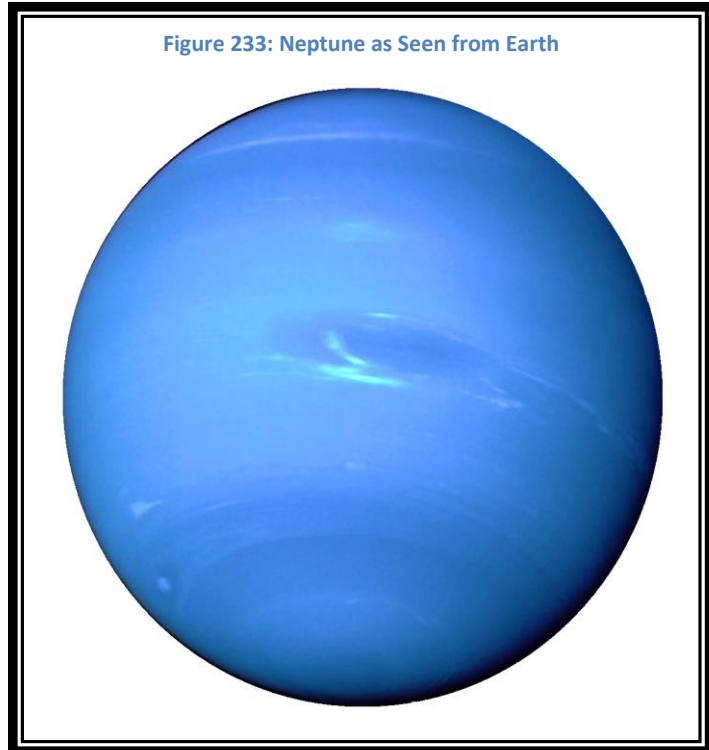
## Component 86 – Neptune's Atmosphere

### Composition

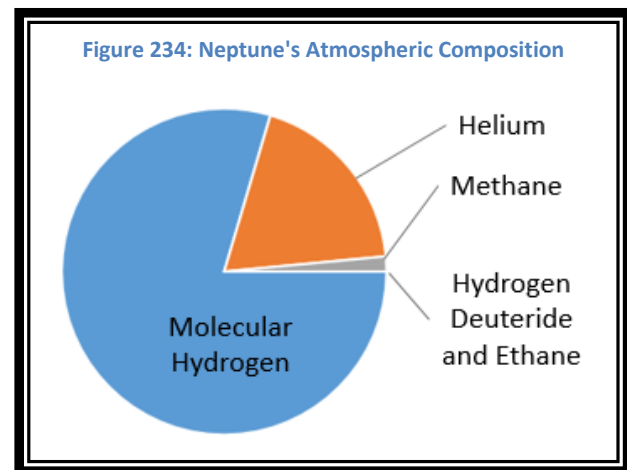
Neptune's atmosphere has a thick layer of methane clouds in the troposphere. Neptune is **blue** due to the different concentrations of **methane** and ethane in the atmosphere compared to Uranus. Methane absorbs red and yellow light so only the bluer colors are reflected back into space.

Some storms can be seen in the cloud-tops of Neptune in large telescopes.

Neptune's outer atmosphere is very similar to Jupiter's. It is mostly molecular hydrogen with some helium and methane. Unlike Jupiter, there is very little ammonia.



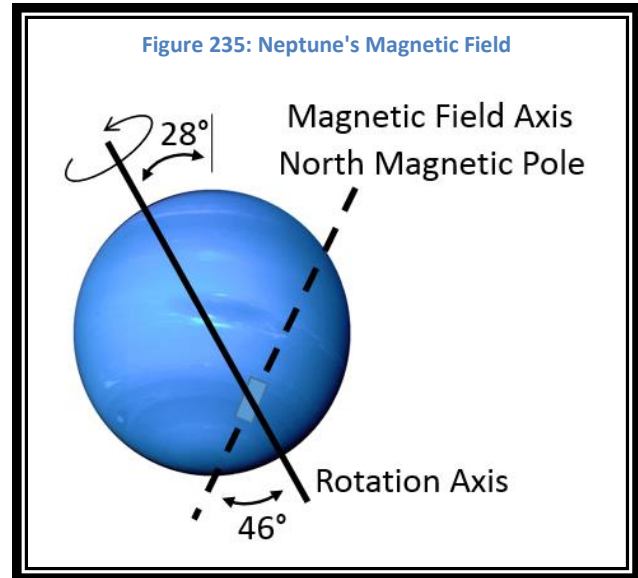
*Methane in Neptune's atmosphere makes it appear bluish*



## Component 87 – Neptune's Magnetosphere

Neptune's magnetic field is **off center** and is **off axis** relative to its Axis of Rotation. The axes are separated by 46 degrees. Its center is located below the equator. Scientists are not sure of the reason for it being off-center.

*Neptune's Magnetic Field is Off Center and has a Significant Difference from the Rotational Axis*



## Component 88 – Neptune’s Moons

Neptune has one large moon and two medium sized moons. It also has 11 small moons for a total of 14 known moons.

Table 20: Neptune’s Major Moons

Name	Distance (km)	Orbital Period (days)	Diameter (km)
Proteus	118,000	4.75	440
Triton	355,000	14.3	2710
Nereid	5,510,000	223	340

### Triton

**Triton** is the only large moon in the solar system whose orbital motion is retrograde. Its surface has two distinct terrains. One is heavily cratered highlands whereas the other is a newer surface with few craters and

Triton is tidally locked to Neptune in the same way that the moon is tidally locked to the Earth. One side is always facing the planet.

Due to its retrograde orbital motion, it is likely that Triton is a captured moon. The most likely scenario at this time is that it was part of a double object which came too close to Neptune: one piece was expelled from the vicinity while the other piece, Triton, was captured gravitationally by Neptune.

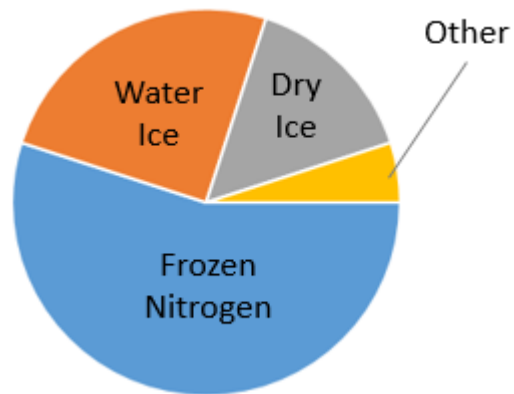
As shown by Figure 303, Triton’s Surface is very different from other moons and planets. Due to the low temperatures, Nitrogen freezes.

It is also possible that Triton’s core has kept the mantle warm enough for Triton to have a liquid water subsurface ocean, similar to Europa.

Figure 236: Triton



Figure 237: Triton’s Surface Composition



## Component 89 – Neptune’s Rings

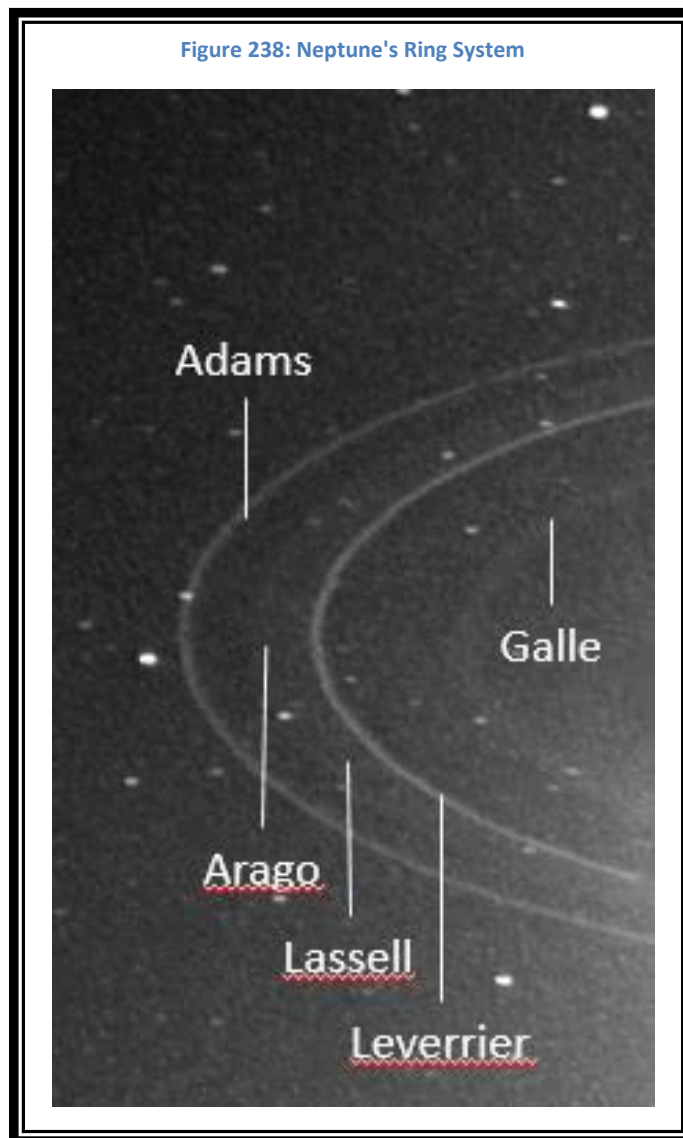
Compared to Saturn and even Uranus, Neptune has a simple ring system. There are **five** rings. Some are thin and well defined, and others are faint and diffuse.

None of Neptune’s rings are visible from Earth.

Table 21: Neptune’s Rings

Name	Inner Radius (km)	Width (km)
Galle	40,900	2000
Leverrier	53,200	100
Lassell	53,200	4000
Arago	57,200	100
Adams	62,900	50

Figure 238: Neptune’s Ring System



## Component 90 – Parade of the Major Moons

The solar system has a wide variety of moons: some were formed as the solar system formed, some were captured, some were the result of collisions.

Some moons are huge, some are quite small. This is a list of those moons that are over 500 km in radius:

Earth’s moon is in fifth place. Pluto’s largest moon, Charon is in 12<sup>th</sup> place.

19 of these moons are large enough to be formed into a rough sphere, and if they were orbiting the Sun directly they would qualify as dwarf planets, and perhaps even planets. Seven (7) of them are actually larger than the known dwarf planets. Ganymede and Titan are actually larger than the planet Mercury.

Table 22: The Largest Moons

Name	Host Object	Radius (km)
Ganymede	Jupiter	2634
Titan	Saturn	2576
Callisto	Jupiter	2408
Io	Jupiter	1818
The Moon	Earth	1737
Europa	Jupiter	1561
Triton	Neptune	1353
Titania	Uranus	789
Rhea	Saturn	765
Oberon	Uranus	761
Iapetus	Saturn	735
Charon	Pluto	604
Umbriel	Uranus	585
Ariel	Uranus	579
Dione	Saturn	563
Tethys	Saturn	536

*Two moons in the solar system are larger than the planet Mercury: Ganymede and Titan*

## Component 91 – Dwarf Planets

Although we have 8 planets in the solar system, we also currently have 5 dwarf planets. These are bodies that don't meet all of the requirements to be a planet.

### The Definition

In 2006 the International Astronomical Union defined what a Planet is. They also defined what a Dwarf Planet is. Their definition only applies to objects within the solar system.

A planet must meet these three requirements:

*According to the IAU, planets must:*

- *Orbit the Sun and no other body.*
- *Be roughly spherical.*
- *Must control objects in their orbit.*

1. It is in orbit around the Sun.
2. It has sufficient mass for its self-gravity to overcome rigid body forces so that it assumes a hydrostatic equilibrium (nearly round) shape.
3. It has cleared the neighborhood around its orbit.

A Dwarf Planet must meet the first two requirements.

Pluto meets the first two requirements but does not meet the third. Pluto crosses Neptune's orbit. Neptune gets Planet status because it controls Pluto's orbit. Neptune's much greater gravity has forced Pluto into a 2 to 3 resonance orbit. For every two orbital revolutions by Pluto, Neptune has three.

The Earth's Moon meets the second requirement; it is round, but it also orbits the Earth and is controlled by the Earth's gravity.

Asteroids satisfy the first requirement but they are not massive enough to have gravity strong enough to satisfy requirements 1 or 3.

### Pluto

Pluto is a Dwarf Planet located in the Kuiper Belt. Its semi-major axis is 39.5 AU. It orbits the Sun every 247.94 years and has a diameter of 2374 km. Its average apparent magnitude is 15.1. Pluto has a very eccentric orbit with an orbital inclination of 17°.

Pluto has 5 moons. They are Charon, Styx, Nix, Kerberos, and Hydra.

Figure 239: Charon



Figure 240: Pluto

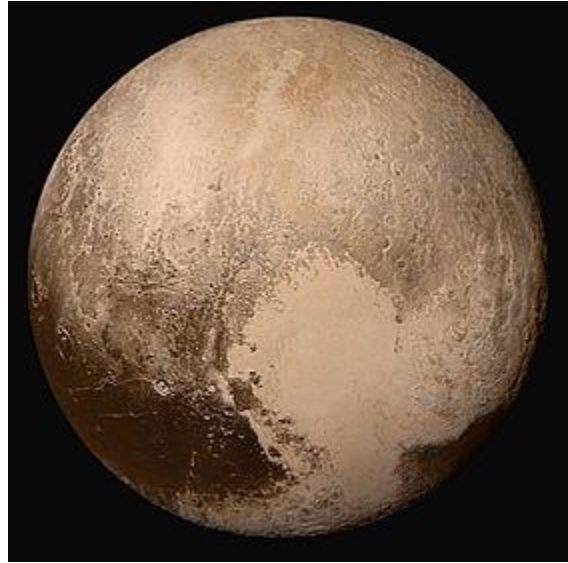
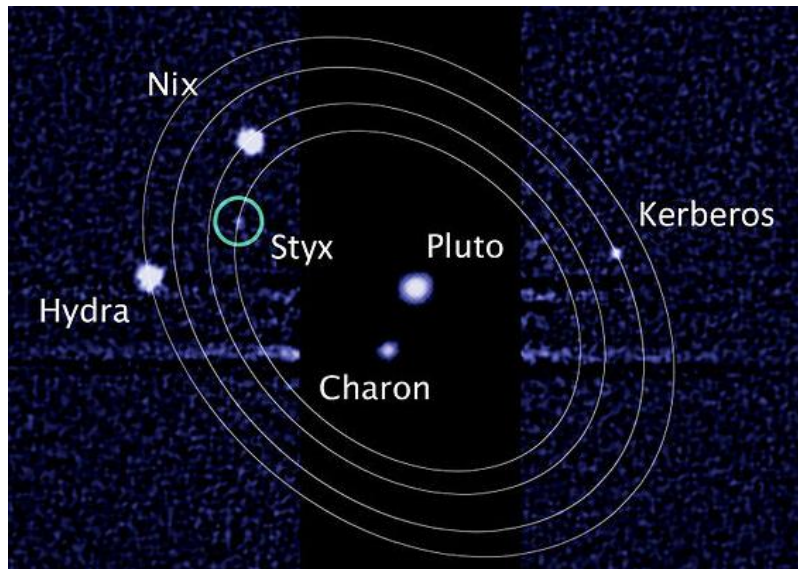


Figure 241: The Orbits of Pluto's Moons

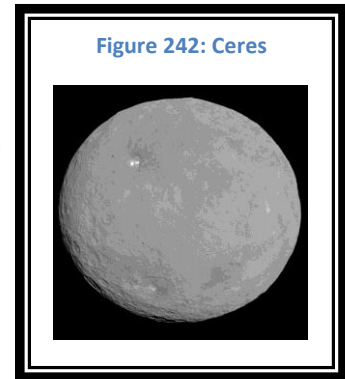


Pluto was discovered by Clyde Tombaugh at the Lowell Observatory in Flagstaff, Arizona in 1930. In 2015 the first spacecraft mission to Pluto, New Horizons, did a fly-by of the planet and its moons.



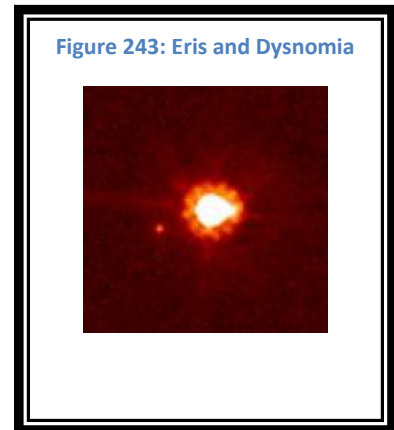
## Ceres

Ceres (pronounced like the word series) is a Dwarf Planet located in the Asteroid Belt. It was formerly Asteroid 1 and is the largest known object in the asteroid belt. Its semi-major axis is 2.77 AU. It orbits the Sun in 4.6 years and has a diameter of 946 km. Its average apparent magnitude is 7.99. Ceres has an orbital inclination of 10.6°. It has no known moons. It was discovered in 1801 by Giuseppe Piazzi at the Academy of Palermo, Sicily.



## Eris

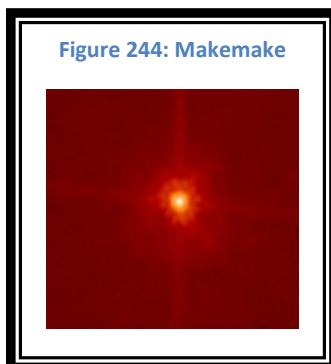
Eris is a Dwarf Planet located in the Scattered Disk. This is a region beyond the Kuiper Belt. This is the object that presented the need to define a planet. If this object is the size of Pluto, there may be many of them. The question was should they all be considered planets? The International Astronomical Union decided that there needed to be another classification of objects.



Eris has a semi-major axis of 67.8 AU. It orbits the Sun in 203.8 days and has a diameter of 2326 km. Its average apparent magnitude is 18.7. Eris has an orbital inclination of 44 °and has a very eccentric orbit. Eris has one known moon named Dysnomia.

## Makemake

Makemake is a Dwarf Planet in the Kuiper Belt and was discovered by a team of astronomers at Palomar Observatory in California in 2005. It has a semi-major axis of 45.7 AU and orbits the Sun in 309.1 years. It has a diameter of 1430 km and a



maximum apparent magnitude of 16.7. Makemake has an orbital inclination of 29 ° and has one known moon named S/2015 (136472) 1.

*There are currently 5 known Dwarf Planets:*

- *Ceres*
- *Pluto*
- *Haumea*
- *Makemake*
- *Eris*

## Haumea

Haumea is a Dwarf Planet in the Kuiper Belt and was discovered in 2004 by a team of astronomers at Palomar Observatory in California. It has a semi-major axis of 43.2 AU and orbits the Sun in 284.1 years. It has a diameter of 1220 km and a maximum apparent magnitude of 17.3. Makemake has an orbital inclination of  $28^\circ$  and has two known moons. The moons are named Hi'iaka and Namaka.

In 2017, the Instituto de Astrofísica de Andalucía discovered a ring around Haumea as it passed in front of a distant star. This opens the possibility that other Juiper Belt objects may have a ring as well.

## Additional Dwarf Planets?

Are there more Dwarf Planets in our solar system? Most likely there are. There are still many undiscovered objects in the Kuiper Belt; some may be large enough to become roughly spherical. Also, some of the known asteroids may also be found to be roughly spherical. There is also the entire sphere of the Oort Cloud that

may contain future Dwarf Planets. At this time we have discovered no Oort Cloud objects.

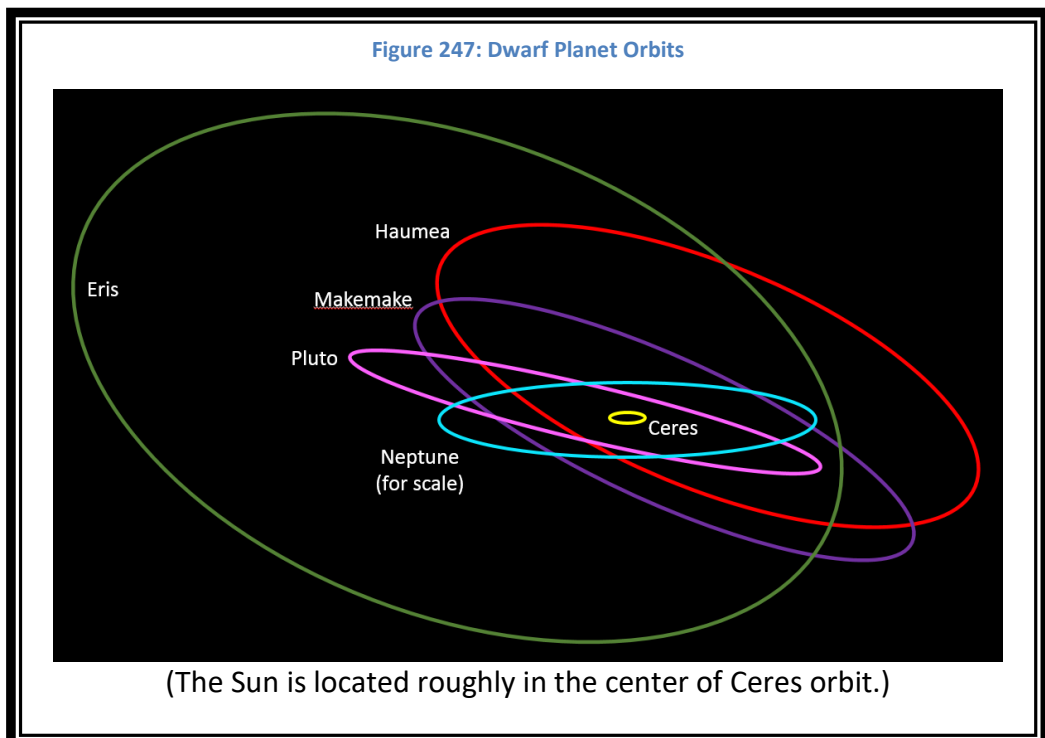
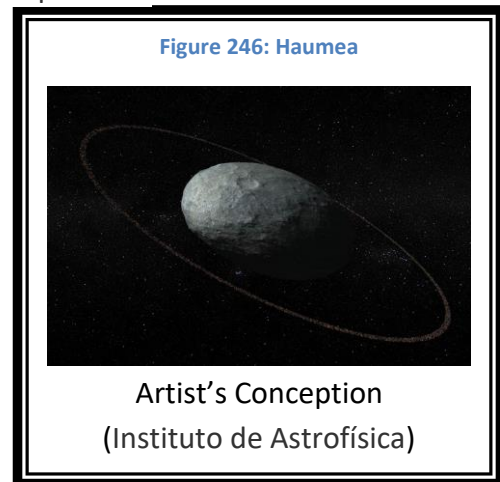
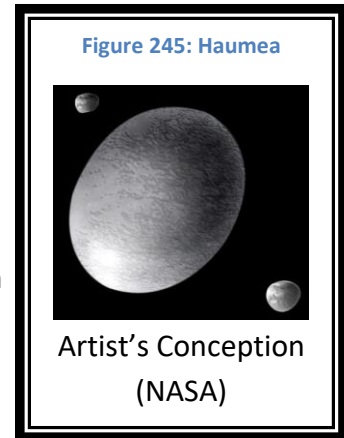
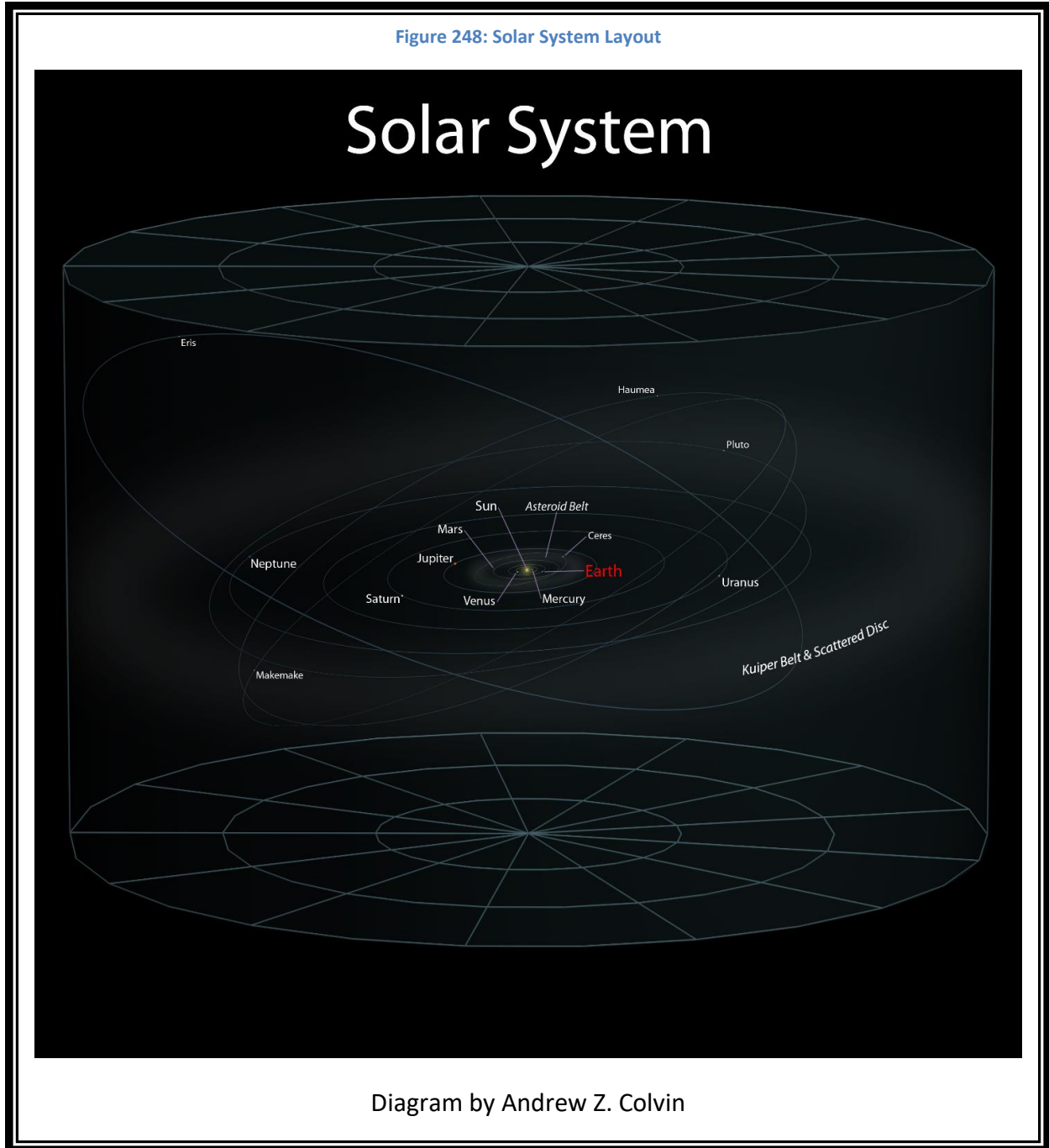


Figure 248: Solar System Layout



The Layout of the Solar System including the 5 known Dwarf Planets is shown in

## Component 92 – Asteroids

Asteroids are stony and metallic objects that are remnants from the formation of the solar system. Most asteroids spend their lives in orbits between Mars and Jupiter. They tend to be oddly shaped and rather small.

### *Asteroid groups:*

- *Main Belt Asteroids*
- *Apoheles Asteroids*
- *Apollo Asteroids*
- *Amor Asteroids*
- *Trojan Asteroids*

Figure 249: Asteroid Ida and Moon Dactyl



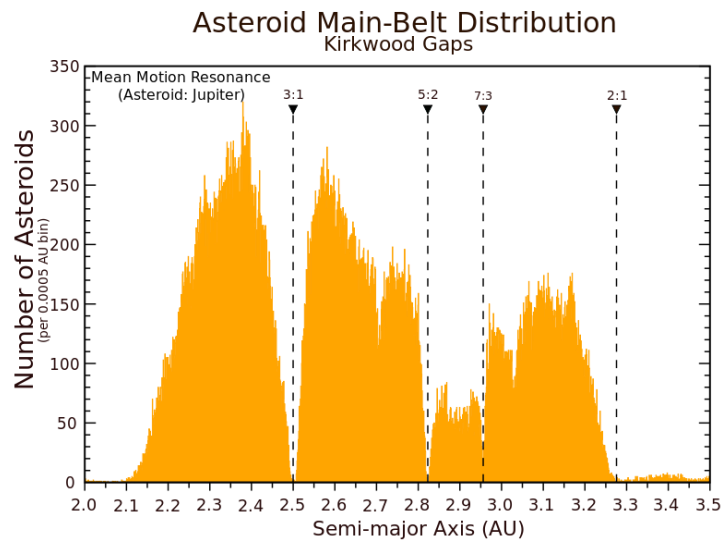
### Asteroid Groups

Asteroids are classified into groups based on their orbits. When an asteroid in a stable orbit between Mars and Jupiter is affected by the gravity of another object, its orbit may change.

If it is moved enough it may join one of the other asteroid families.

**Main Belt Asteroids.** The majority of known asteroids are **Main Belt Asteroids**. They orbit the Sun between Mars and Jupiter's orbits. There are gaps in the Asteroid Belt that are caused by resonant orbits with Jupiter's orbit. These gaps are shown in Figure 316, and are called **Kirkwood Gaps**. As of 2022, there are a total of 1,113,527 known asteroids.

Figure 250: Kirkwood Gaps



**Apoheles Asteroids.** **Apoheles Asteroids** are those asteroids with an orbit completely within the orbit of the Earth. 16 of these asteroids have been found so far. Their orbits bring them close enough to the Earth that they are considered threats.

**Apollo Asteroids.** **Apollo Asteroids** are those asteroids with an orbit that crosses Earth's orbit. There are 6923 known asteroids in this group. These are Near Earth Asteroids and are considered a threat to Earth.

**Amor Asteroids.** Asteroids with orbits that cross Mars' orbit are called **Amor Asteroids**. There are 3729 known Amor Asteroids. Many of these come close enough to Earth's orbit to be considered a threat to Earth. It is believed that Mars' moons may have been Amor Asteroids that came too close to Mars and were captured.

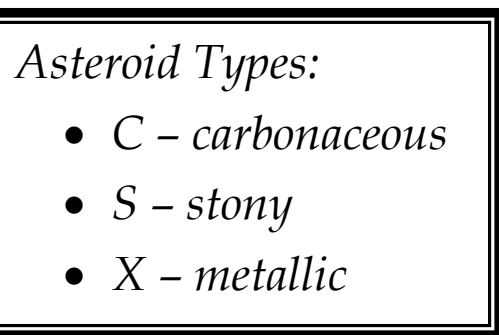
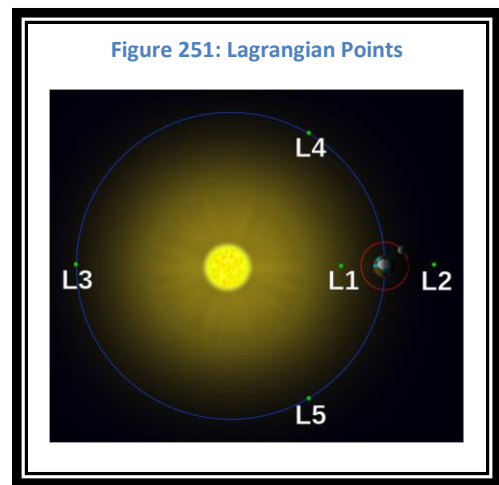
**Trojan Asteroids.** **Trojan Asteroids** are asteroids that are stable in a planet's L<sub>4</sub> and L<sub>5</sub> Lagrangian Points.

- There is one known Earth Trojan Asteroid discovered in 2010.
- Mars has 7 known Trojan Asteroids.
- So far, 6178 Trojan Asteroids have been found in Jupiter's Lagrangian Points.
- No Saturn Trojan Asteroids have been found.
- One Uranus Trojan Asteroid has been found.
- 13 Neptune Trojan Asteroids have been found.

### Asteroid Types and Groups of Types

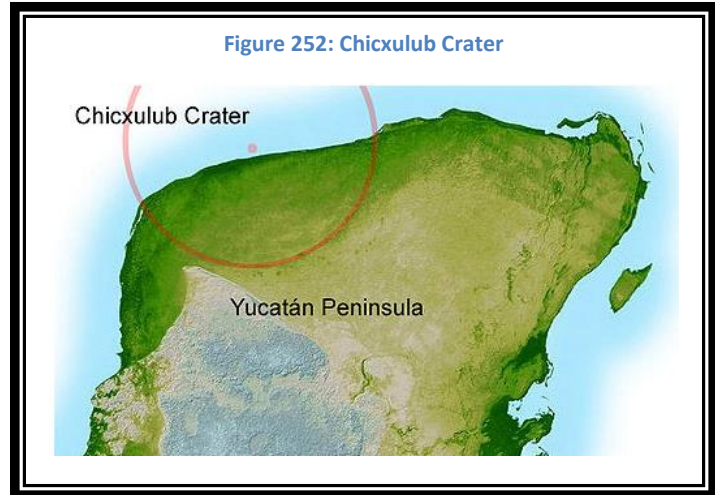
Asteroids are also classified by their composition. These are the major types and groups of asteroids:

- C group: These are dark **carbonaceous** asteroids. There are four types in this group: B, F, G, and C.
- S type: These are **silicates** or stony asteroids.
- X group: These are **metallic** asteroids. There are three types in this group: M, E, and P.
- There are also a number of small classes of asteroids that do not fit into these major classifications. They are types: A, D, T, Q, R, and V.



### The End of the Dinosaurs

It is likely that the dinosaurs were in decline 66 million years ago, but it is broadly accepted that the impact of an asteroid in the area of today's **Yucatan Peninsula** in Mexico was the final blow. It may have been only taken hours to years, but in a relatively short time the dinosaurs became extinct. The Chicxulub Crater is about 110 miles wide and the asteroid is believed to have been between 5 and 15 km in diameter. This scientific theory is supported by a layer of sediment which is believed to have been the ejecta from the impact. This layer is found all over the Earth in the boundary between the Cretaceous and the Tertiary Periods. Under this layer of sediment there are dinosaur bones. Above it there are none.



### Other Asteroid Impacts Around the World

There are many impacts that have been identified around the world. One very famous one is in Arizona. It is the **Barringer Crater**. The crater is a mile wide and 570 feet deep. 50,000 years ago a meteor travelling at 20 km/sec hit the Earth. It was approximately 150 feet in diameter and weighed 300,000 tons. Other examples include the **Wolf Creek Crater** in Australia and the **Manicouagen Crater** in Canada



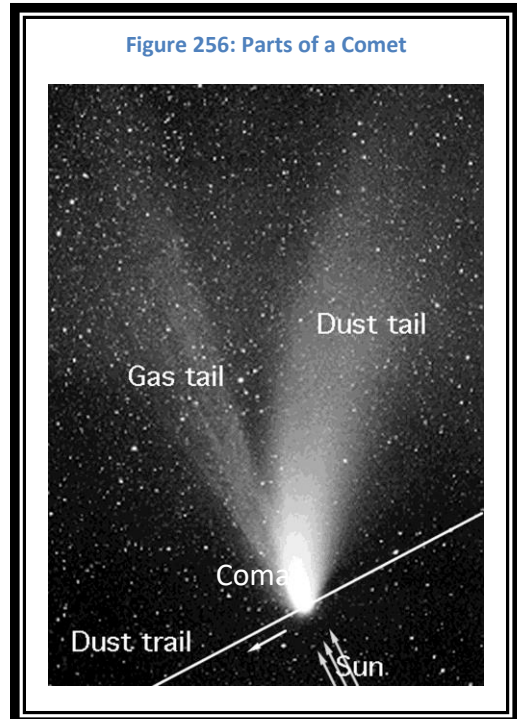
## Component 93 – Comets

Comets are icy objects that originate in the Kuiper Belt or the Oort Cloud. When their orbits are disturbed they may change to bring them much closer to the sun. When they are in this new orbit they are called Comets. Comets resemble dirty snowballs. They contain ices and dust.

### Parts of a Comet

As a comet approaches the Sun it heats up. This heat causes some of the icy parts of the comet to turn into gas. As these gases escape the comet they take some of the dusty material with them. Comets have these components:

- **Nucleus:** the solid body at the center of the comet.
- **Coma:** a ball of gas and dust surrounding the nucleus of the comet.
- **Dust Tail:** a stream of dust that is escaping from the comet. This tail points away from the Sun but is affected by the motion of the comet so often appears slightly curved.
- **Gas Tail:** a stream of gas that is escaping from the comet. This tail points directly away from the sun. This is also often called the Ion Tail.
- **Hydrogen Envelope:** an area of hydrogen gas that surrounds the comet and the tails.



### *Parts of a Comet:*

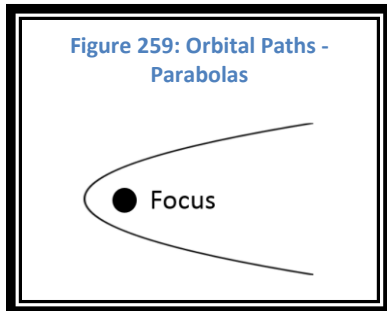
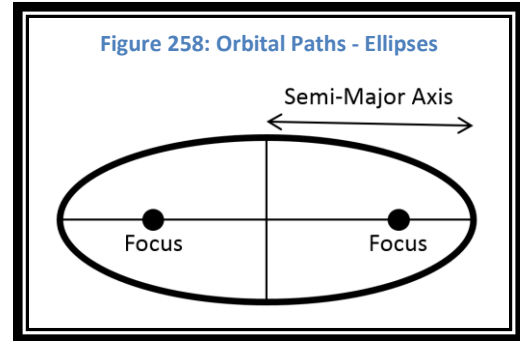
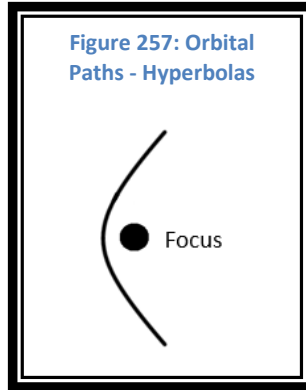
- *Nucleus*
- *Coma*
- *Dust Tail*
- *Gas Tail*
- *Hydrogen Envelope*

*Comets are balls of ice and dirt; like a dirty snowball*

## Paths of Comets

Orbits of all celestial bodies must be of one of these types:

- **Circular**
- **Elliptical**
- **Parabolic**
- **Hyperbolic**



No objects orbit in perfect circles. Those comets in elliptical orbits will return to the inner solar system time after time. Those comets in parabolic or hyperbolic orbits will pass our way and then leave the solar system never to return.

Comets are broken into two main groups: Long Period Comets and Short Period Comets. Short Period Comets are those whose orbital period is under 200 years. These comets are thought to have originated in the **Kuiper Belt**. Long Period Comets have a period of over 200 years. These comets are thought to have originated in the **Oort Cloud**. Comets become showy objects as they move in close to the Sun. The frozen gases in the nucleus of the comet vaporize and eject gas and dust into space. The closer they get to the Sun, the more gas and dust they eject. The closer to Earth that they pass, the brighter and more impressive they appear.

*Short Period Comets - < 200 years, originate in the Kuiper Belt*

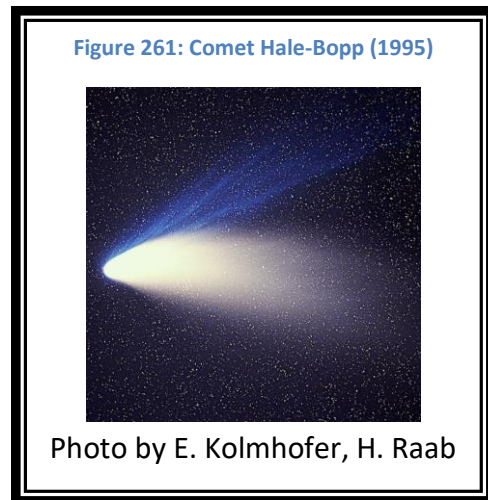
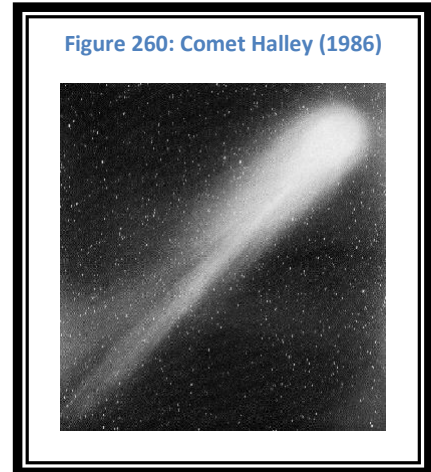
*Long Period Comets - > 200 years, originate in the Oort Cloud*



## Famous Comets

There are some comets that have earned a place in history. They are special because of their regularity, impressive show, or because of special events that occurred in their passage through the inner solar system.

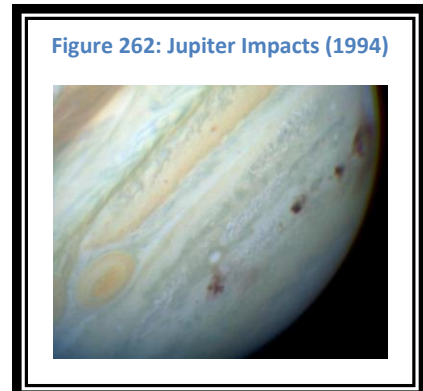
**Halley's Comet.** Perhaps the most famous comet is Halley's Comet. This comet has a 76 year orbital period and has been observed since 240 BC. It was recorded by the Chinese and Babylonian astronomers. Its last visit was in 1986, and it will return in July, 2061. Halley's apparition in 1986 was not particularly impressive. It was not close enough to Earth to put on a show.



**Comet Hale-Bopp.** The comet that has set the standard for what comets should look like was Hale-Bopp. Its orbital period is estimated to be 2525 years.

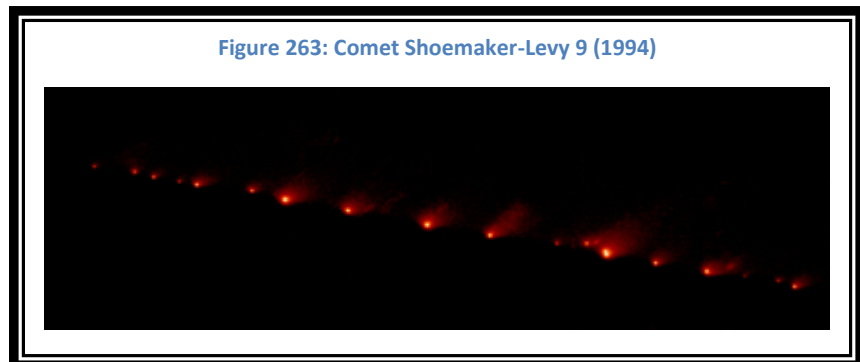
**Comet Shoemaker-Levy 9.** Shoemaker-Levy 9 demonstrated what astronomers had believed for many years: Solar system objects do interact. In fact, they interact all of the time.

In 1992, this comet passed close to Jupiter. It actually passed within Jupiter's Roche



Limit. Jupiter's gravitational forces pulled the comet apart. In 1994 these cometary fragments approached Jupiter even more closely. This time the fragments slammed into the planet, one after another. The resultant dark spots in

Jupiter's clouds were larger than the Earth. As Jupiter rotated, the spots came into view to telescopes on Earth.

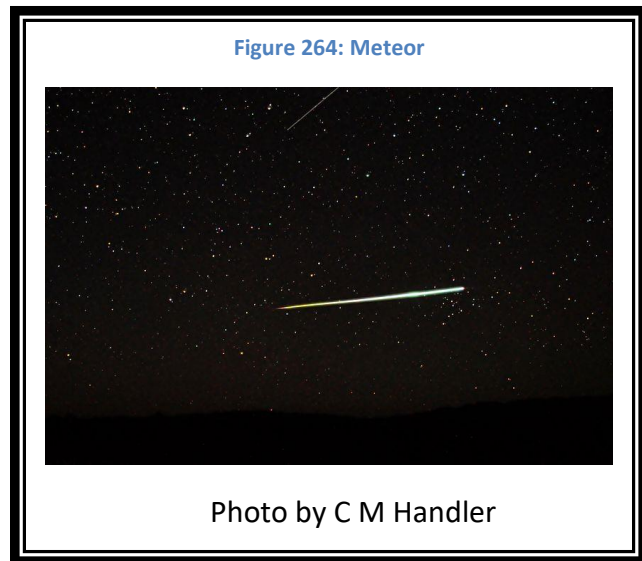


## Component 94 – Meteoroids

We have met most of the Solar System family. The only piece left is the smallest members. On a dark night with no moon, if you watch the sky you will see streaks of light. These streaks go by many colorful names: Shooting Stars or Falling Stars. Their formal name is Meteors. Meteors are small bits of rock that come too close to the Earth's atmosphere and are pulled in by Earth's gravity.

### Naming of Phases of Meteor's Life

Meteors, when they are in space are called **Meteoroids**. They are small asteroids: anything smaller than 100 yards in diameter is considered a Meteoroid. Most meteorites are the size of a grain of sand, but even these tiny particles may shine in the sky. As they enter the Earth's atmosphere they excite electrons in the atoms and molecules in the air, which emit photons as they return to ground state. At this time they are called **Meteors**. If they are larger than the size of a marble, then they may reach the Earth's surface and they will become **Meteorites**.



### *Stages of a Meteoroids Life:*

- *Meteoroid – In Space*
- *Meteor – Streaking Through the Atmosphere*
- *Meteorite – on the ground*

### Origins of Meteors

Every night there are sporadic meteors. These are meteors that are not associated with a specific meteor shower but are dust in the plain of the solar system that wanders into the path of the Earth.

Each year, the Earth passes through dust trails that were left in the orbits of **comets** as they orbit the Sun. When this happens we see meteor showers. There are 11 major annual meteor

showers, a number of medium, and many minor, showers. Major **Meteor Showers** have 10 or more meteors per hour (ZHR – **Zenith Hourly Rate**). Minor showers may have as few as two.

Table 23: Origins of Annual Meteor Showers

Name	Source
Quadrantids	(not known)
Lyrids	C/1861 G1 (Thatcher)
Eta Aquariids	1P/Halley
Arietids	96P/Machholz
Daytime Zeta Perseids	(not known)
Perseids	109P/Swift–Tuttle
Daytime Sextantids	(not known)
Orionids	1P/Halley
Leonids	55P/Tempel–Tuttle
Geminids	3200 Phaeton

**Radiants.** Meteors in a meteor shower appear to come from one point in the sky. This is called the **Radiant**. This is an illusion. It is caused by the same effect that makes a pair of railroad tracks seem to meet in a single point on the distant horizon. The showers are named after their radiants.

Table 24: Major Annual Meteor Showers

Name	Dates	Peak	Speed	ZHR
	(as of 2015)	(as of 2015)	(km/s)	
Quadrantids	12/28 to 1/12	1/3	41	120
Lyrids	4/16 to 4/25	4/22	49	18
Eta Aquariids	4/19 to 5/28	5/6	66	55
Arietids	5/22 to 6/2	6/7	37	54
Daytime Zeta Perseids	5/20 to 7/5	6/9	27	20
Perseids	7/17 to 8/24	8/13	59	100
Daytime Sextantids	9/9 to 10/9	9/27	33	20
Orionids	10/2 to 11/7	10/21	66	20
Leonids	11/6 to 11/30	11/17	71	15
Geminids	12/4 to 12/17	12/14	35	120

**Note:** Meteor Showers with thousands of meteors per hour are called **Meteor Storms**.

**Note:** The best time to view most Meteor Showers is when there is no moon in the sky, away from lights, and in the pre-dawn hours.

**Composition**

Meteors are rocky bits and are classified into three main groups:

- **Stoney**
- **Stoney-Iron**
- **Iron**

*Three Classes of Meteorites:*

- *Stoney*
- *Stoney-Iron*
- *Iron*

These groups are then broken up into sub-classes.

Figure 265: Inside a Stoney Meteorite



Photo by H. Raab

Figure 266: An Iron Meteorite



Photo by H. Raab

Figure 267: Inside a Stoney-Iron Meteorite

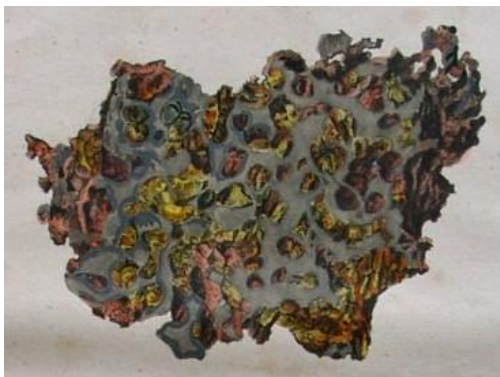


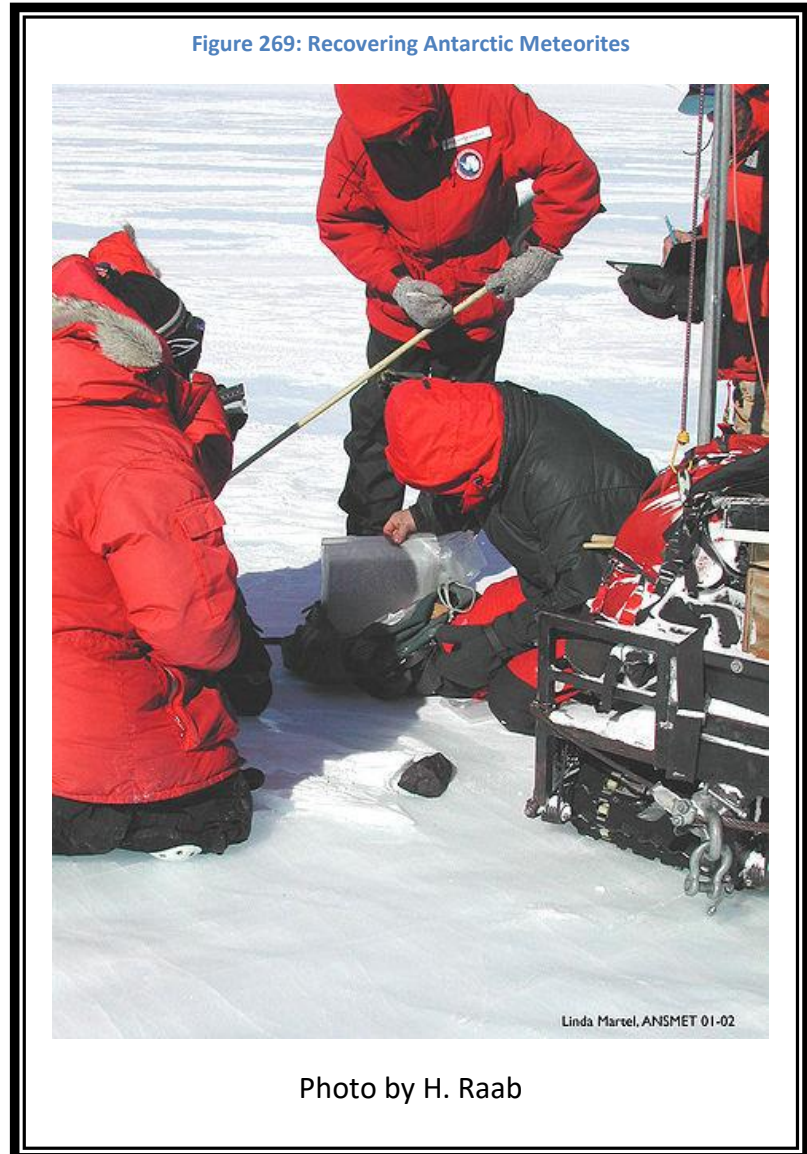
Photo by C.v.Schreibers

Figure 268: Inside an Iron Meteorite



Photo by H. Raab

**Note:** Many meteorites are recovered from the snow and ice in Antarctica. This environment makes them easy to find and they remain very pristine in the frozen conditions.



**Useful Meteor Related Links**

American Meteor Society: <http://www.amsmeteors.org/>

International Meteor Organization: <http://www.imo.net/>

## Component 95 – The Kuiper Belt, Oort Cloud and Extrasolar Visitors

As you travel outward from the sun, you leave the realm of the planets and reach the icy outer regions of the solar system. This is the home of the icy objects. They all appear similar to dirty snowballs and have three regions where they exist: The Kuiper Belt, the Scattered Disk, and the Oort Cloud.

### The Kuiper Belt

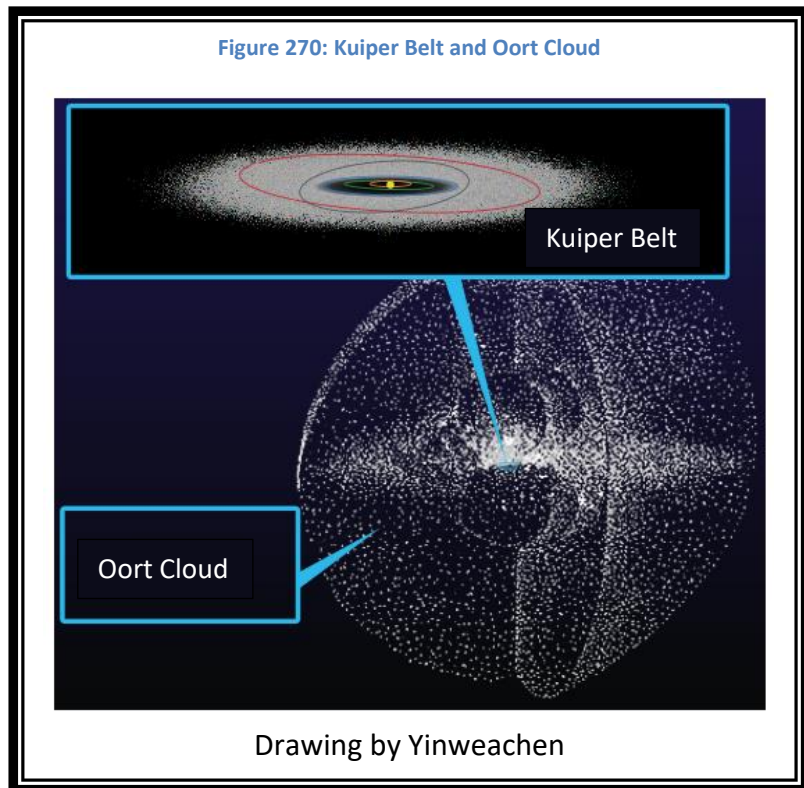
The **Kuiper Belt** is the region beyond the orbit of Neptune. It extends from 30 to 50 AU from the sun. The largest member of this family is Pluto, the dwarf planet. Dwarf planets Makemake and Haumea are also part of the Kuiper Belt family. This region is a disk similar to the asteroid belt. Short period comets are believed to have originated in this region.

### The Scattered Disk

The **Scattered Disk** is a sparsely populated area extending from the Kuiper Belt to the Oort Cloud. This is a region that shares objects with the Kuiper Belt. They too are icy bodies. Eris, the dwarf planet, is one of the Scattered Disk objects.

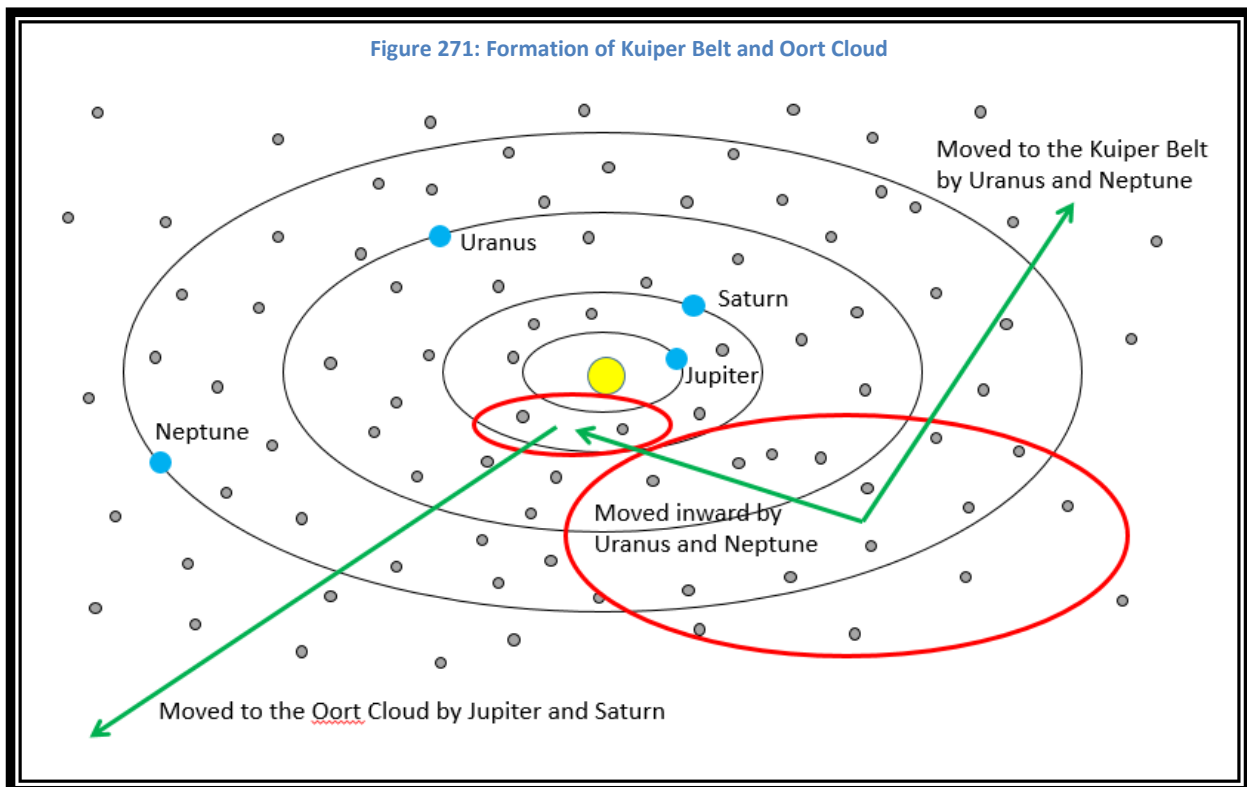
### The Oort Cloud

The **Oort Cloud** is a spherical shell of icy bodies beyond the Scattered Disk. No objects have been discovered in this region. Long period comets are believed to have originated in this region.



### How They Formed

As the solar system was forming, icy planetesimals would have existed in large numbers beyond the orbit of Jupiter. Once the planets were formed they had significant gravitational influence on everything in their neighborhood. From about 5 million years after the Sun began to form to approximately 1 billion years later the large outer planets caused the planetesimals to migrate outward. Those inside of Saturn's orbit (the **inner solar system**) would have received a large nudge from the biggest planets, Saturn and Jupiter, and would have been moved out to the Oort Cloud. Those beyond the orbit of Saturn (the **outer solar system**) would have been nudged by the slightly smaller planets, Uranus and Neptune, and would have been moved more gently and only to the Kuiper Belt.



- *The Kuiper Belt was formed by planetesimals from the outer solar system*
- *The Oort Cloud was formed by planetesimals from the inner solar system*

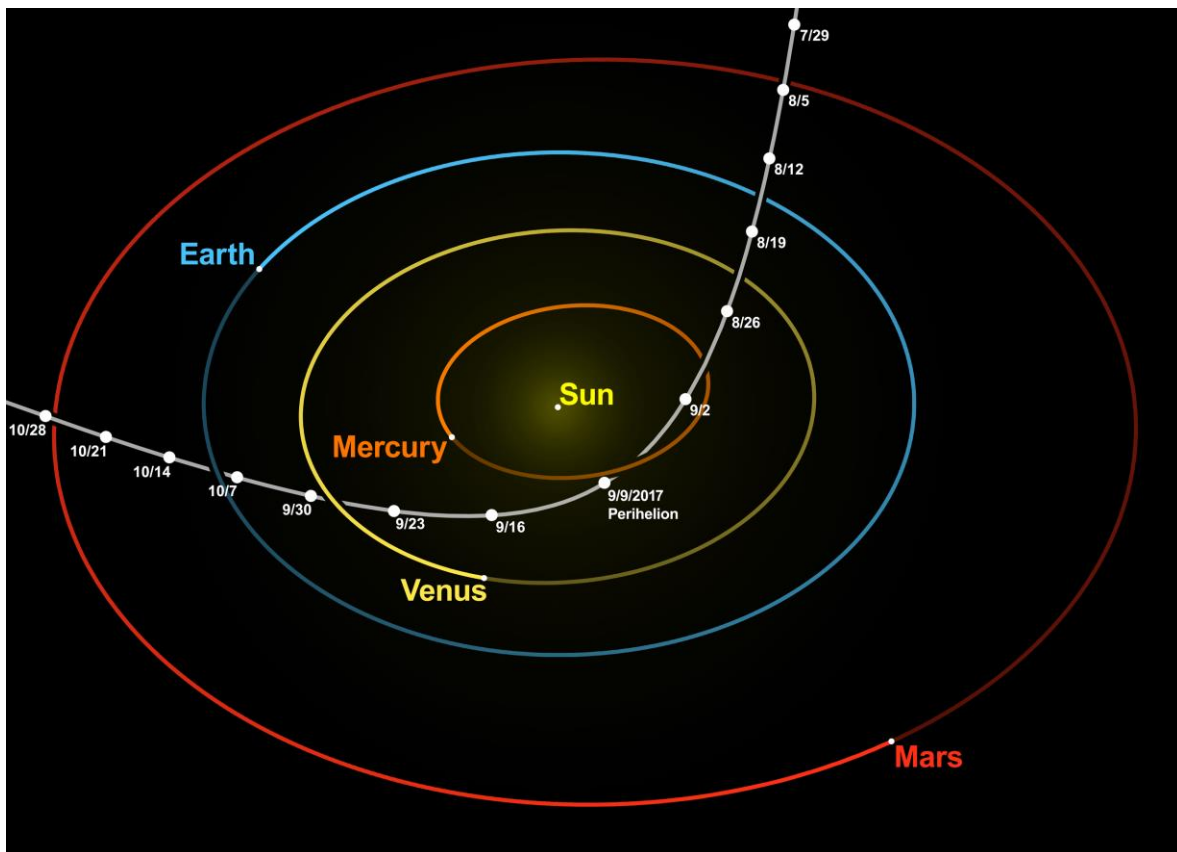
### Deep Space Visitors

Most objects that we know about in the solar system, were born in the solar system. Scientists have believed for many years that there should be visitors from outside the solar system, but none have ever been identified until 2017. A metallic object called 1I/2017 U1 ('Oumuamua) was observed flying through the solar system. Its trajectory implies that it is a visitor from outside the solar system. This is the first and only object of its kind ever observed.

Figure 272: 1I/2017 U1 ('Oumuamua)

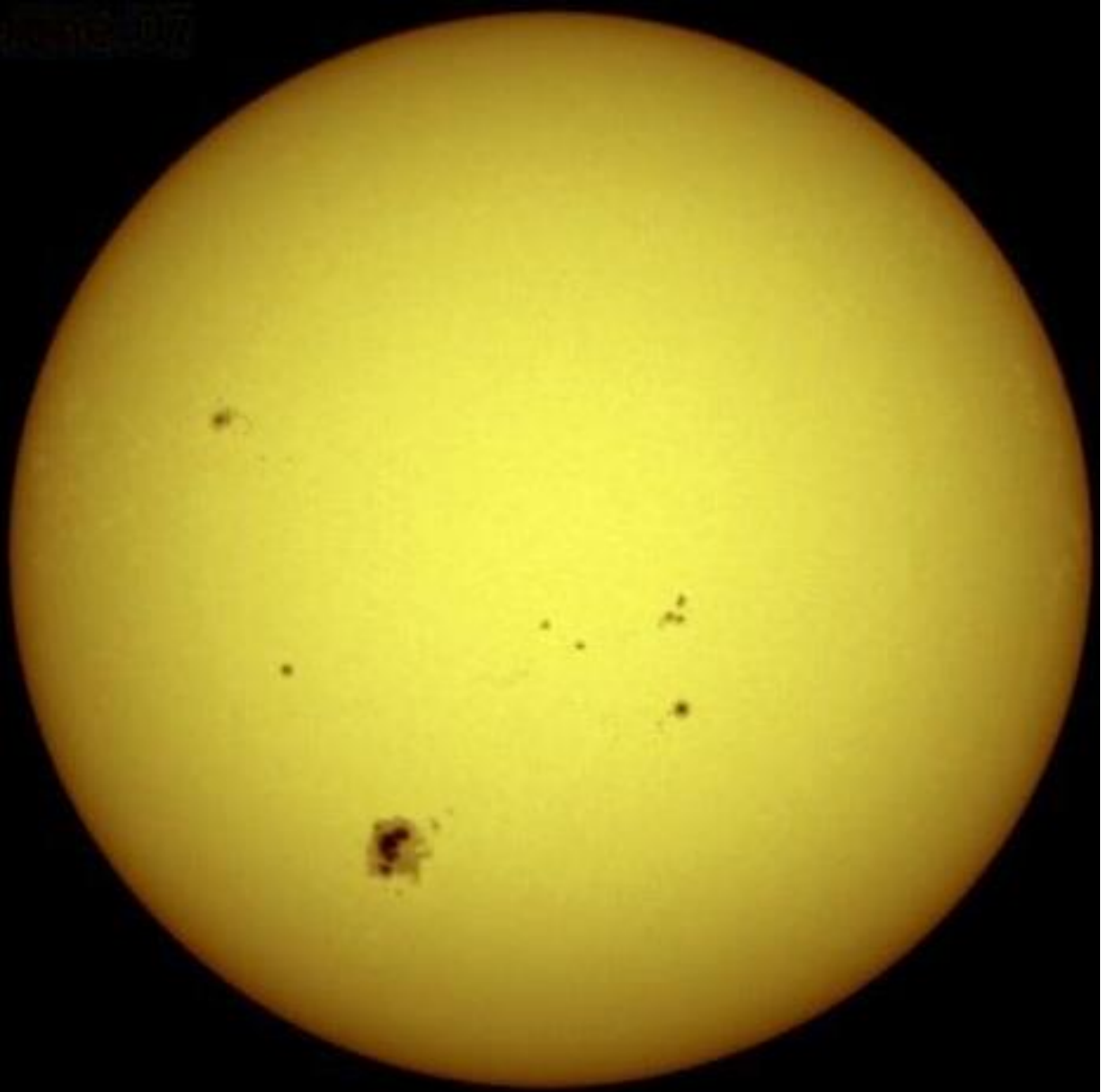


Figure 273: Path of 'Oumuamua





**\*\*\* SECTION V. ASTRONOMY – SOLAR**



## Component 96 – Stellar Habitable Zones

Every star has a **Habitable Zone**. If we can define what is required for life to emerge and thrive, then we can define the zone around stars that is most likely the home for habitable planets.

### What is a Habitable Zone?

A Habitable Zone is defined as the region around a star within which it is suitable for life as we know it to evolve. The only planet on which we know that life has evolved is **Earth**. The only life that we are familiar with is the life on the planet Earth. So our perception of the requirements for life is defined by this one situation: Earth.

On Earth, it appears that life requires liquid **water**, many different elements (atoms) and a large supply of carbon (or hydrocarbons). On Earth we have abundant liquid water, carbon and other elements. There are many places in the universe with abundant carbon and other elements, but liquid water is only found in regions around a star where it is warmer than the temperature at which water freezes and also cooler than the temperature at which water boils. These limits can be calculated if you know the temperature of the star (see Equation 13).

Equation 13: Distance as a Function of Luminosity and Temperature

$$d = \sqrt{\left(\frac{L}{16 * \pi * \sigma * T^2}\right)}$$

L = Luminosity in Solar Luminosities ( $L_{\odot}$ )

T = Temperature in Kelvin (freezing = 273 K, boiling = 373 K)

$\pi$  = Pi = 3.14159265358979323...

$\sigma$  = The Stefan-Boltzmann Constant =  $5.67 \times 10^{-8} \text{ W m}^{-2} \text{ K}^{-4}$

### *Techniques to find Extrasolar Planets:*

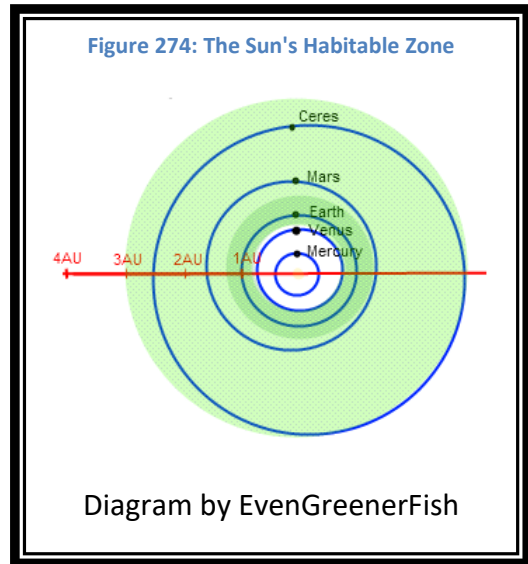
- *Transits*
- *Radial Velocity*
- *Direct Imaging*
- *Microensing*
- *Timing*

### The Sun's Habitable Zone

For the Sun, the habitable zone extends from roughly **Venus'** orbit, includes **Mars**, and to the inner parts of the Asteroid Belt (past **Ceres'** orbit).

### Other Habitable Zones in the Solar System

Recently, scientists believe that there may be additional habitable zones within the solar system. If the requirements for life to develop exist, and the conditions are adequate, then it is possible for life to develop and evolve.



**Titan.** Although too cold for liquid water to exist, Saturn's moon **Titan** has liquid hydrocarbons on its surface. Evolution would move very slowly at the chilly temperatures, but with the plentiful hydrocarbons it is possible that the complex molecules needed to life could exist.

**Europa and Ganymede.** It is believed that Some of Jupiter's moons, such as **Europa** and **Ganymede**, may have subsurface liquid salt-water oceans. Too far from the Sun to be in its habitable zone, gravitational energy from Jupiter could provide the energy necessary to form an ideal environment in which life could evolve.

**Other Forms of Life.** It is always difficult for people to imagine possible alternatives to what we see around us. When scientists search for places to find life, they focus on places similar to Earth. They search around stars that are similar to the Sun. They search for life similar to life found on the Earth. But, it is possible that life may take many different forms. These forms may be so strange and different from life we see on Earth that it is difficult for us to recognize them. Even on Earth, we find life where we would not expect it: deep in the Earth's crust, deep in the oceans where no light can reach, and even in hot springs where the water is so hot that most forms of life would perish immediately. As we learn more and discover more, we are forced to change our thinking. This is a great example of how scientific theories evolve.

## Component 97 – The Sun's Data

### The Sun

- Mass 1,988,500 x 10<sup>24</sup> kg (33,300,000 % Earth)
- Mean Radius 696,000 km (10,920 % Earth)
- Gravity 274 m/s<sup>2</sup> (2,800 % Earth)
- Escape Velocity 617.6 km/s (5,520 % Earth)
- Axial Tilt 7.25 ° (30.9 % Earth)
- Apparent Magnitude **-26.74**
- Absolute Magnitude **4.83**
- Spectral Type **G2V**
- Mass Conversion Rate 4,300,000,000 kg/s
- Central Temperature 15,710,000 K
- Surface Temperature **5,778 K**
- Rotation Rate (hrs.) 609.12 (2,544.9 % Earth)

*The Sun is a  
G2V Star*

### The Sun's Magnetic Field

- Polar 1 to 2 Gauss
- Sunspots 3000 Gauss
- Prominences 10 to 100 Gauss

### The Sun's Atmosphere

- Composition (very thin atmosphere):
  - **Hydrogen** 90.965 %
  - **Helium** 8.889 %
  - Oxygen 774 ppm
  - Carbon 330 ppm
  - Neon 112 ppm
  - Nitrogen 102 ppm
  - Iron 43 ppm
  - Magnesium 35 ppm
  - Silicon 32 ppm
  - Sulfur 15 ppm

For the latest information on technical data for the Sun, go to NASA's website:

<http://nssdc.gsfc.nasa.gov/planetary/factsheet/sunfact.html>

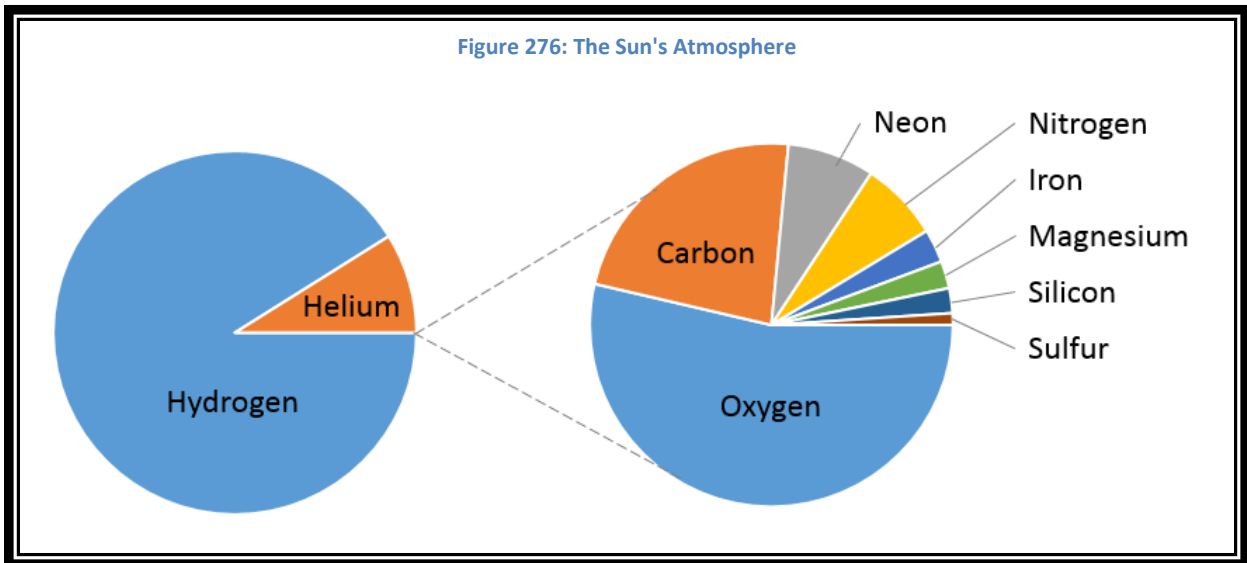
## Component 98 – The Sun’s Atmosphere

### Composition

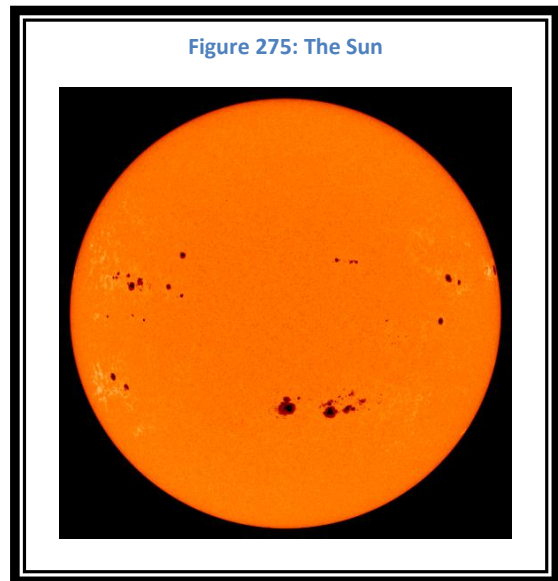
The Sun’s atmosphere has a large amount of Hydrogen and significant amount of Helium. Interestingly, its third most abundant element is Oxygen, although there is much less of it.

**Table 25: The Sun's Atmosphere**

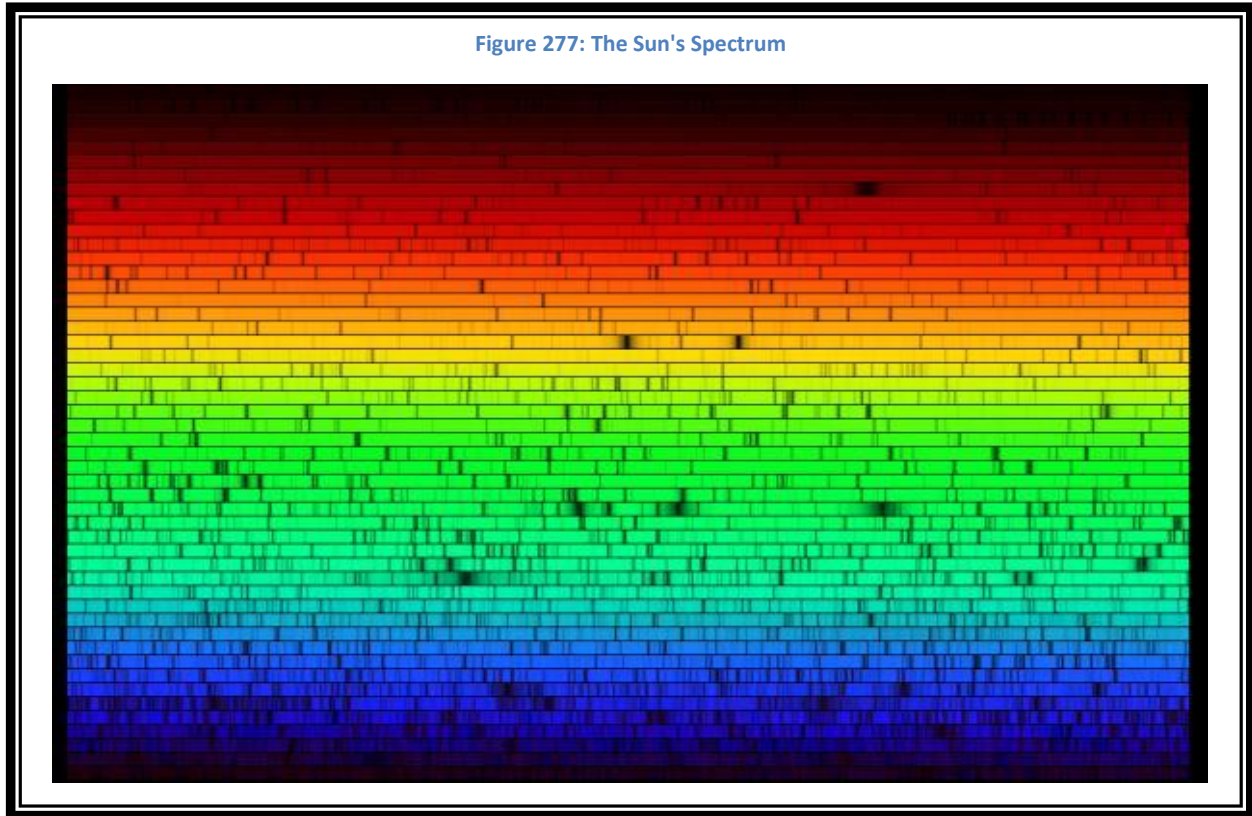
Element	Proportion	Element	Proportion
<b>Hydrogen</b>	90.97%	Nitrogen	102 ppm
<b>Helium</b>	8.89%	Iron	43 ppm
Oxygen	774 ppm	Magnesium	35 ppm
Carbon	330 ppm	Silicon	32 ppm
Neon	112 ppm	Sulfur	15 ppm



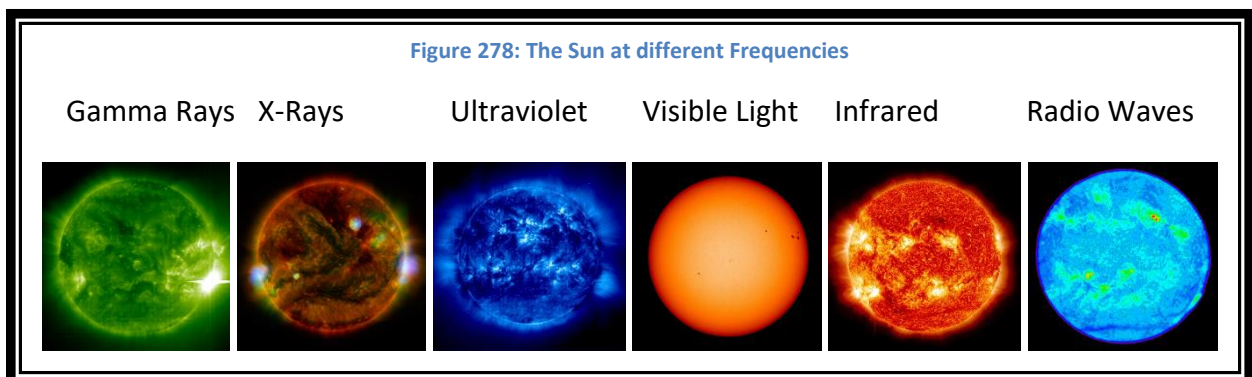
*The Sun is composed of approximately 90% hydrogen and 10% helium*



## Component 99 – The Sun's Spectrum



If you look closely at the Sun's spectrum you see thousands of dark spectral lines. They are caused by absorption of specific frequencies by elements present in the atmosphere. 67 elements have been identified spectroscopically. In the case of stars, like the Sun, the absorption lines and the background blackbody radiation are created in the upper atmosphere.

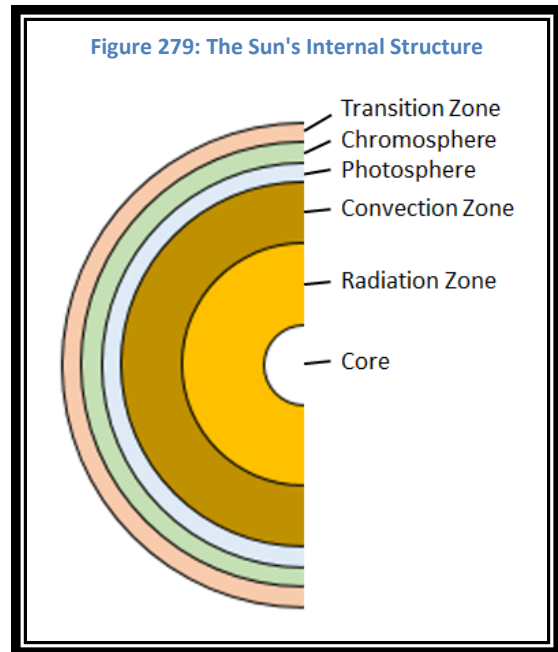


## Component 100 – The Sun’s Structure

The Sun has a differentiated structure. Each layer has distinctive properties and characteristics. The

**Table 26: The Sun's Internal Structure**

Layer	Thickness
Core	200,000 km
Radiation Zone	300,000 km
Convection Zone	200,000 km
Photosphere	500 km
Chromosphere	1,500 km
Transition Zone	8,500 km
Corona	706,000 km
Solar Wind	18,100,000,000 km



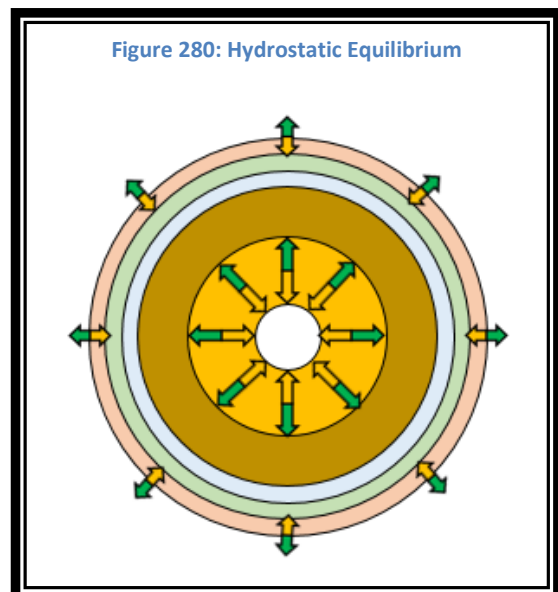
### Core

The Core of the Sun is where all of the fusion occurs. The Sun is fusing hydrogen into helium. This process creates pressure. The core temperature is almost 16 million K.

*All of the sun's fusion occurs in the Core*

### Hydrostatic Equilibrium

During a human lifetime, the Sun does not change significantly. On average, the mass, radius, luminosity, and temperature do not vary. This means that the outward pressure of the fusion (green arrows in Figure 346) is balanced with the inward pressure due to gravity (orange arrows in Figure 346) in a main sequence star like the Sun. This is called **Hydrostatic Equilibrium**.



### **The Radiation Zone**

The Radiation Zone of the Sun is that layer inside the Sun where the Sun's energy moves outward from the core through the process of radiation. This means the energy is moved from the core outwards by electromagnetic radiation.

### **The Convection Zone**

The Convection Zone of the Sun is the layer above the Radiation Zone. Here the Sun's energy is moved upwards through the motion of the material of the Sun. This zone is very similar to a boiling pot of water on the stove. Hotter material rises and cooler material sinks towards the core.

### **The Photosphere**

The Sun's Photosphere is a level above the Convection Zone. This is the part that we normally consider to be the surface of the Sun. This is the part we see in telescopes with white light solar filters.

### **The Chromosphere**

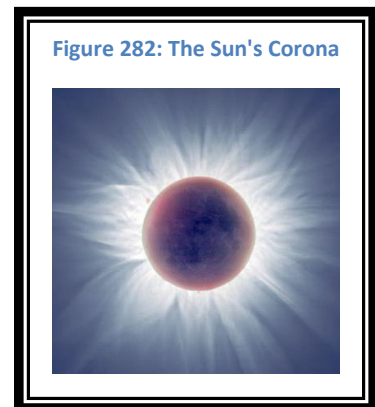
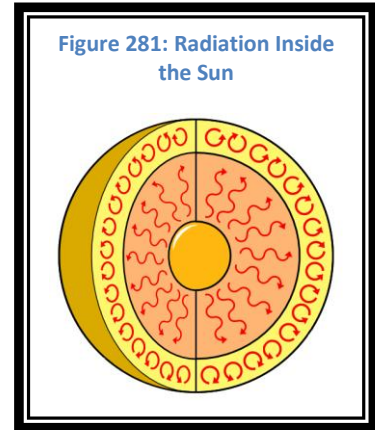
The Chromosphere is the layer of the Sun above the Photosphere. This is the lowest layer of the sun's atmosphere. It is the layer with the lowest temperature. This is the layer that is visible with an H-Alpha Solar Telescope.

### **The Transition Zone**

The Transition Zone is the middle layer of the Sun's atmosphere. In this relatively narrow layer, the temperature changes from the lowness of the Chromosphere to the very hot Corona.

### **The Corona**

The Corona is the outer layer of the Sun's atmosphere. The temperature here is very hot, but the gas is low-density. This layer is only visible during total solar eclipses.





## The Solar Wind

The Solar Wind is the last part of the Sun. This is the region from the Corona to the edge of the Sun's push due to the solar wind, the heliopause. The solar wind is charged particles leaving the Sun and moving quickly outward into the solar system.

## Helioseismology

How do we know what is going on inside the Sun? On Earth we learn about the layers inside our planet by studying the results of seismology studies. On the Sun, it is not possible to place seismographs on the surface. And if we could, are there sunquakes that we can listen for to understand the structure? The answer to this last question is yes! There are very complex vibrations occurring on the Sun. They are similar to the ringing of bells. We are able to detect these vibrations and analyze the data. These complex waves can be broken down into their component waves, and these waves tell us about the internal structure of the Sun.

In the same way that different types of seismic waves on Earth bounce off the different layers in the Earth, so too will the different types of seismic waves bounce off the different layers in the Sun.

Note the path that photons follow to leave the Sun. In the Radiation Zone the photon passes from one atom to the next.

Figure 283: Solar Vibrations

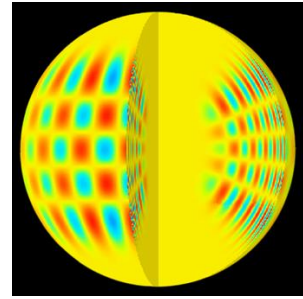


Diagram by the US Government

Figure 284: Detailed Solar Structure

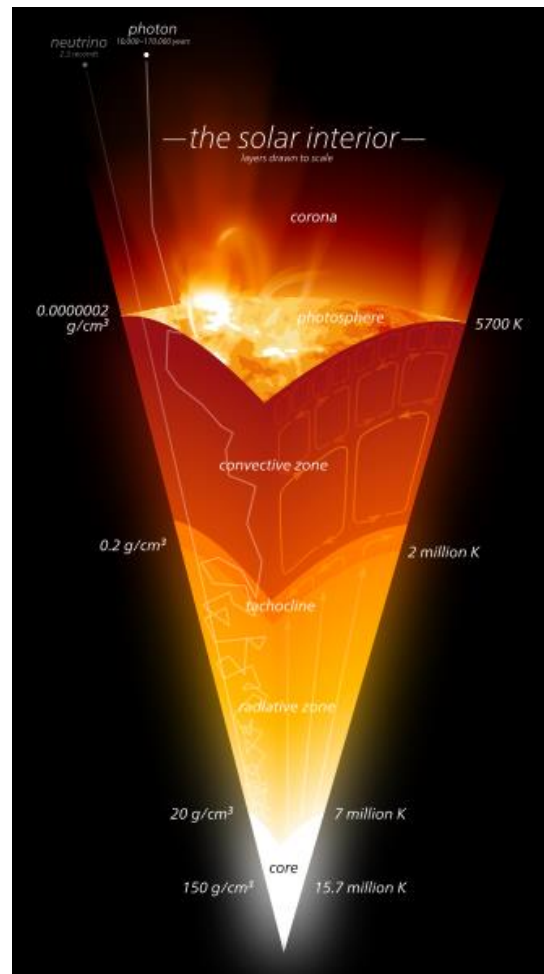


Diagram by Kelvinsong

## Component 101 – The Sun's Surface

The surface of the Sun that we see depends on the frequency of the light we are looking at. When we take images of the Sun in visible light frequencies, we see the photosphere. When we use a hydrogen-alpha telescope we see the chromosphere.

The tops of the convection cells in the upper Convection Zone result in granulation that is visible on top of the Photosphere.

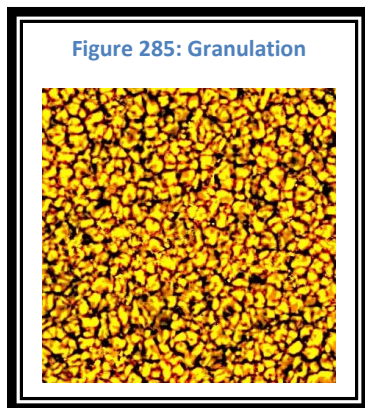


Figure 285: Granulation

### Sunspots

**Sunspots** are not really cool or dark, they are simply cooler than the surrounding surface of the Sun, and therefore appear darker. They usually come in pairs. One sunspot is the location where one pole of a magnetic field exits the Sun. The other sunspot is the location where the magnetic field re-enters the Sun. The inner and darker part of the spot is called the **Umbra**. The not-so-dark outer area is called the **Penumbra**.

Sunspots are thought to be caused by the Sun's differential rotation. The equator rotates faster than the surface nearer the poles. This stretches the Sun's magnetic field lines. At times these field lines warp and extend out into the Sun's lower atmosphere. This produces the prominences that we see.

### Sunspot Cycles

The Sun's magnetic polarity is believed to switch every 11 years. Sunspots appear in a 22-year **Sunspot Cycle** composed of two of these 11-year parts. During the first part, in the northern hemisphere, the leading spot in each pair is the north magnetic pole. In the southern hemisphere it is the southern magnetic pole. During the second part of the cycle the magnetic poles are switched.

*Solar observation is the only dangerous observing that astronomers do:*  
**NEVER LOOK AT THE SUN!**

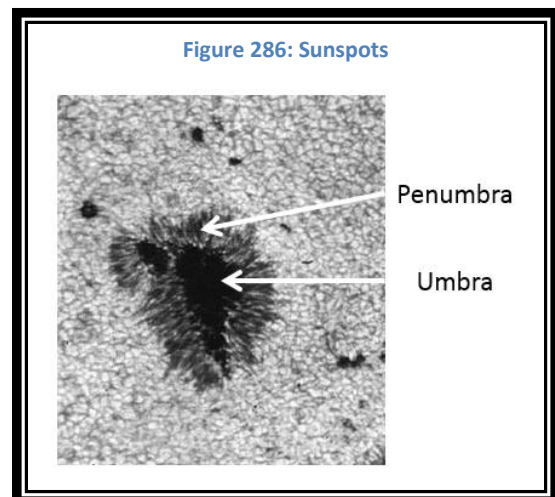
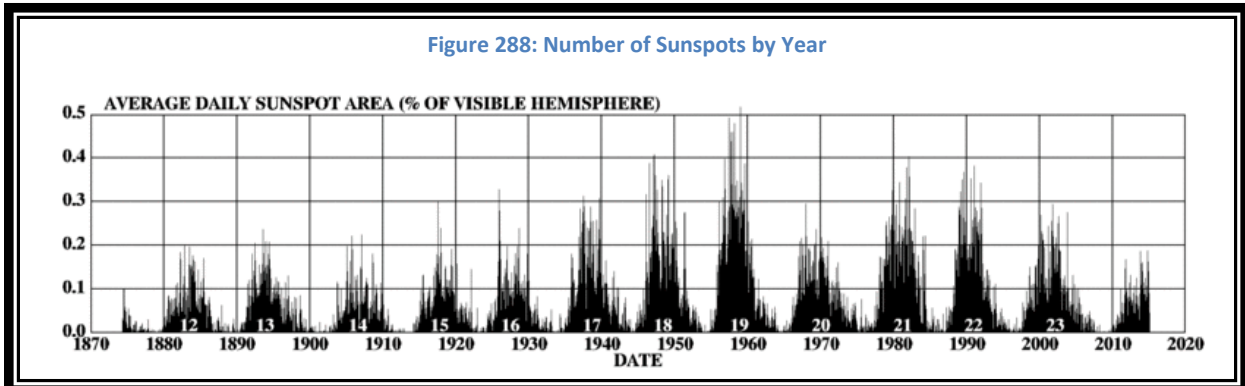
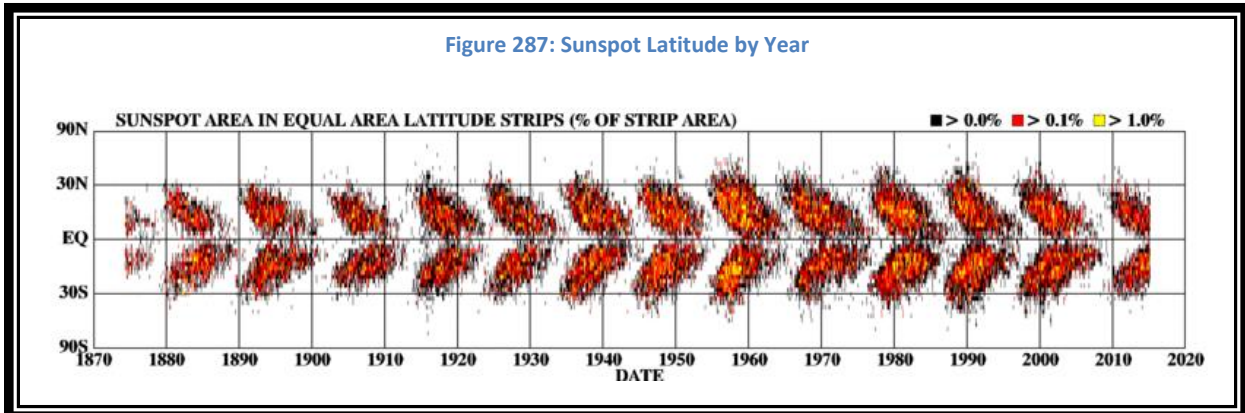


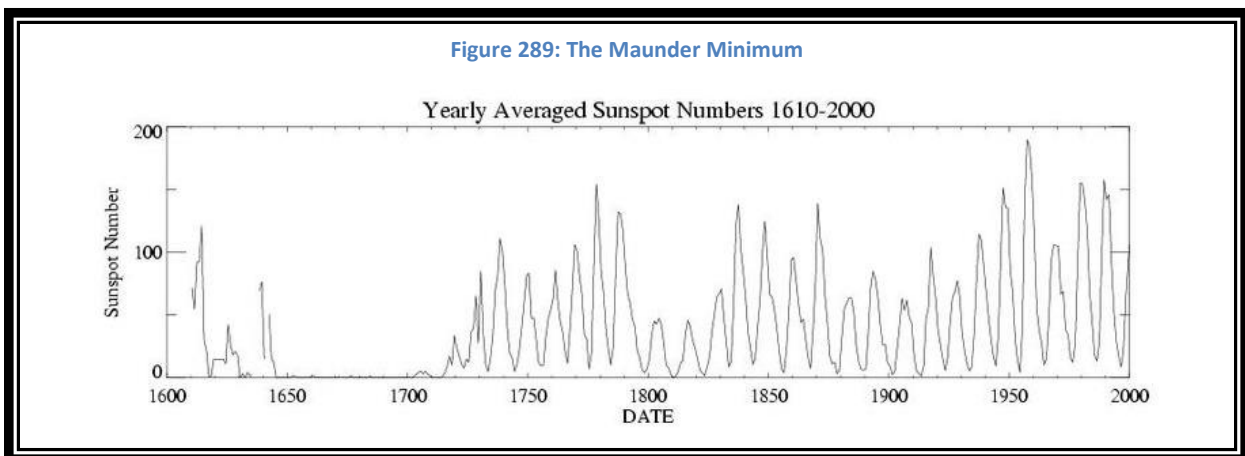
Figure 286: Sunspots

Each piece of the cycle begins with very low sunspot activity. The activity increases to a maximum and then returns to near zero (see Figure 354).

During each piece of the cycle the sunspots first appear farther away from the equator, and as the cycle progresses they are located closer to the equator (see Figure 353).



In the late 1600s there was an extended period of time when there were few sunspots. This is referred to as the **Maunder Minimum** (see Figure 355). This resulted in a drop in solar radiation and a corresponding drop in temperature on the Earth and a mini-ice age.



Using a hydrogen-alpha telescope we are able to see details of these prominences near the Sun's surface. They are especially pronounced when they occur around the edge of the disk.

### **Solar Flares**

Solar Flares are short-lived eruptions on the surface of the Sun. They are close to the surface, only last a few minutes and are quite violent (Figure 356).

### **Solar Prominences**

**Solar Prominences** may last for weeks. They are large but less violent eruptions on the Sun's surface (Figure 357).

### **Coronal Mass Ejections**

At times, giant clouds of charged material are ejected from the Sun. These are called a **Coronal Mass Ejections**. They occur weekly during low sunspot activity, and a few times each day during peak activity. These clouds of material move quickly out into the solar system (Figure 358).

When the charged particles of a Coronal Mass Ejection reach Earth they put pressure on the sunward side of the Earth's magnetosphere. The charged particles in the cloud spiral around the magnetic field lines as they migrate towards the magnetic poles. As they enter the atmosphere, they are responsible for the aurorae we see.

These charged particles can have serious consequences for electrical equipment. Satellites are put to sleep to prevent damage, and astronauts seek shelter in protected areas of the Space Station.

Coronal Mass Ejections originate on the Sun's surface in regions called **Coronal Holes** (Figure 359). These are thin regions in the Sun's corona where there is a high-speed solar wind. Large holes may last decades and can be hundreds of thousands of kilometers across. Smaller holes may appear every few hours.

Figure 290: Solar Flares

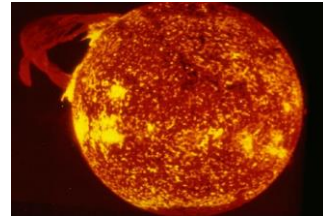


Figure 291: Solar Prominence

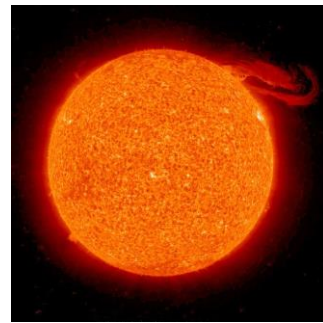


Figure 292: Coronal Mass Ejection

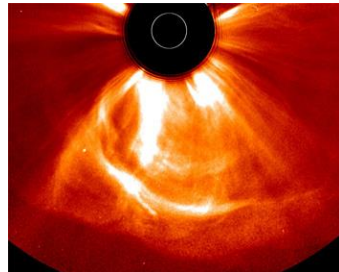
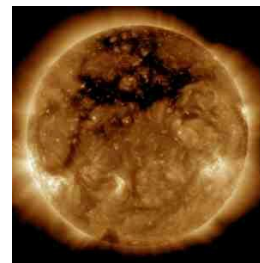


Figure 293: Coronal Hole



## Component 102 – Fusion in the Sun

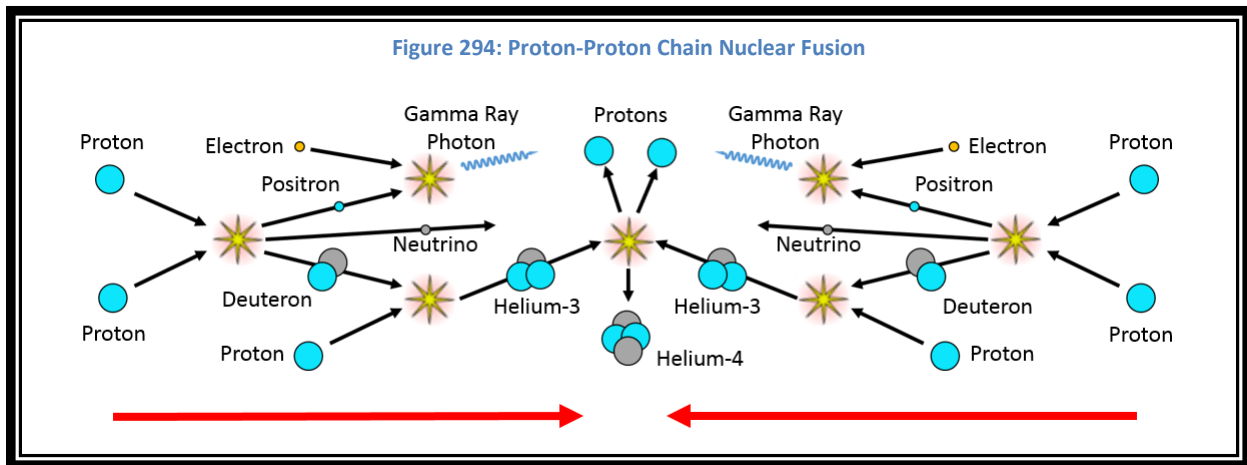
### What is Fusion?

Fusion is the combining of smaller nuclei to create larger nuclei. This is the process through which all of the elements of the periodic table are created. When two nuclei fuse together some mass is converted into energy and is emitted as photons.

Nuclei of atoms are positively charged. Things of similar charge repel each other, just as the north poles of two magnets will repel each other. In order to make fusion possible, it is necessary to get the nuclei close enough together so that the strong force will overcome the electromagnetic force and cause the nuclei to stick together. Stars accomplish this by very high pressures – which force the nuclei closer together, and very high temperatures – which cause the nuclei to move faster and overcome much of the repulsive force.

### Proton-Proton Chain Fusion

For a star similar to the Sun or smaller, the primary fusion process to convert hydrogen into helium is **Proton-Proton Fusion**. Once the core temperature reaches approximately 10,000,000 K, there is enough energy to start the fusion process.



Overall, 6 **protons** and two electrons combine to form 1 **helium** atom, 2 protons, 2 **neutrinos** and two gamma ray photons. Note that two of the protons are returned to be used in other fusion reactions. Protons make **Deuterium**, which then makes **Helium 3**, which then makes Helium. The **positrons** combine with electrons to produce **gamma rays**. This is the process that the sun uses to convert hydrogen into helium.

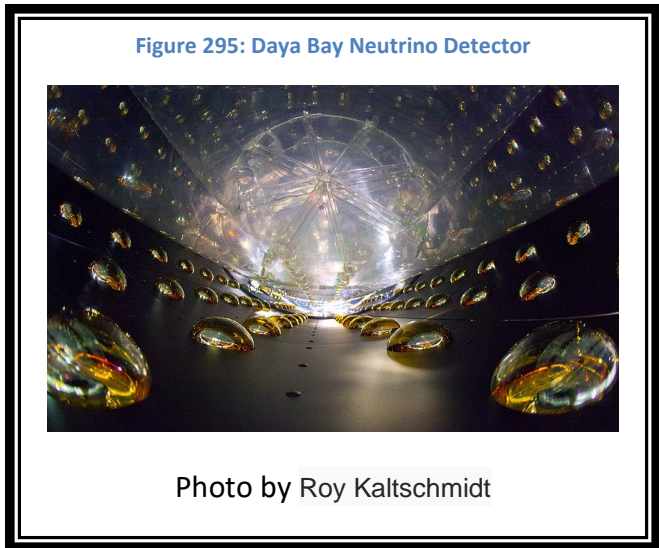
### Neutrinos – “the little ones”

In the Sun, the gamma rays are transformed into other frequencies of electromagnetic radiation before they exit the sun. This means that there is no direct evidence in the emitted electromagnetic radiation to confirm that the proton-proton-chain process is occurring inside the core of the Sun. The only other evidence emitted is the neutrinos. Neutrinos are very small, travel very fast, and tend not to interact with matter. They are able to exit the Sun in a few seconds after they are created.

*The Sun makes Helium from four Protons*

We have built large detectors to try to confirm the presence of the neutrinos. One type of detector uses chlorine or gallium to detect the neutrinos. When a neutrino strikes an atom, chlorine changes into argon and gallium changes into germanium. Both of these atoms are radioactive and emit radiation which can easily be detected. Another design uses a large chamber of water surrounded by photodetectors. When a neutrino impacts an electron in a water molecule, the electron is accelerated to close to the speed of light. It then gives off ultraviolet photons which can be detected.

Although the detectors have detected solar neutrinos, they do not detect the number that is expected based on the model. This shortcoming is called the Solar Neutrino Problem. Since the experiments were done with very high accuracy and precision, either the theory is wrong and less neutrinos are being produced in the Sun, or for some reason they are not making it to the detectors.



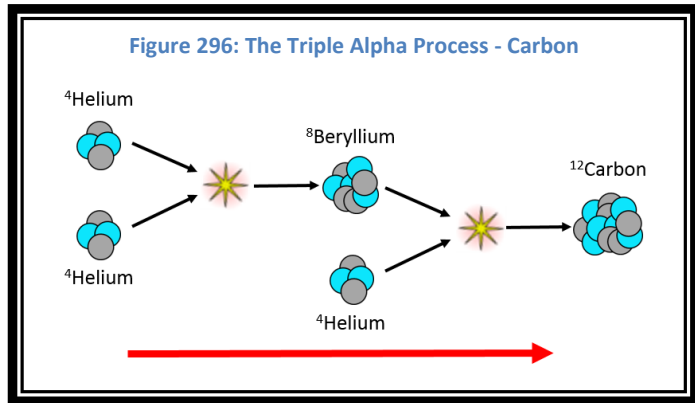
Since the physics seems to correlate with other known models and data, it is likely that the answer may be in the neutrinos themselves. It is believed that neutrinos experience **Neutrino Oscillations**. This means that the neutrinos change into another type of neutrino. In 2002 evidence was found to support the theory that

*The Solar Neutrino Problem was that we were not detecting enough neutrinos.*

the neutrinos created in the Sun are making it to Earth as expected, and through the oscillations, they have been detected in the appropriate quantities.

### Other Fusion in the Sun

Once the Sun has made enough helium from hydrogen to build up a helium core, and as the quantity of hydrogen available for fusion decreases, the core will contract and begin to fuse helium into carbon (the **Triple Alpha Process**) and a little oxygen.



Two helium nuclei will fuse together to form beryllium when the core reaches the right pressure and temperature. This beryllium nucleus then fuses with another helium nucleus to form **carbon**. The beryllium nucleus has four protons and four neutrons. It is unstable and its half-life is  $6.7 \times 10^{-17}$  seconds. This means that the next helium nucleus must be there within that time (on average) or the beryllium will decay back into two helium nuclei. The temperature required for helium fusion is 100,000,000 K. The carbon nucleus is stable.

A small amount of carbon fusion will occur near the surface of the carbon core and a small amount of oxygen will be created.

Sun-like stars are not massive enough to have sufficient gravity to continue the process of core contraction and associated increases in temperature and pressure. Fusion of heavier elements is not possible.

*The Sun is too small to fuse its carbon into oxygen or any heavier elements.*

*The Sun will end its life as a white dwarf with a core of mostly carbon and a little oxygen*





**\*\*\* SECTION VI. ASTRONOMY – STARS and GALAXIES**



## Component 103 – The Motion of Stars

Everything in space is in motion relative to everything else. As Einstein noted, there is no absolute frame of reference. This is true for all stars. But living on Earth, our primary interest is in how they move relative to us. In astronomy we use spherical coordinates to describe where an object is relative to Earth. The Earth is at the center of the sphere defined by what we can see from the Earth's surface. We can use two coordinates. Right Ascension and Declination, to locate any star on that sphere.

### Transverse Motion and Transverse Velocity

When a star is moving on the sphere, this appears to us as **Transverse Motion**. The speed at which it is moving is its Transverse Velocity. It can be measured as an angular velocity (arc-seconds per century), or if we know the distance, then it can be measured in units of distance (kilometers per second). This motion is also called Proper Motion. This motion can be measured directly from observations of the star taken years apart.

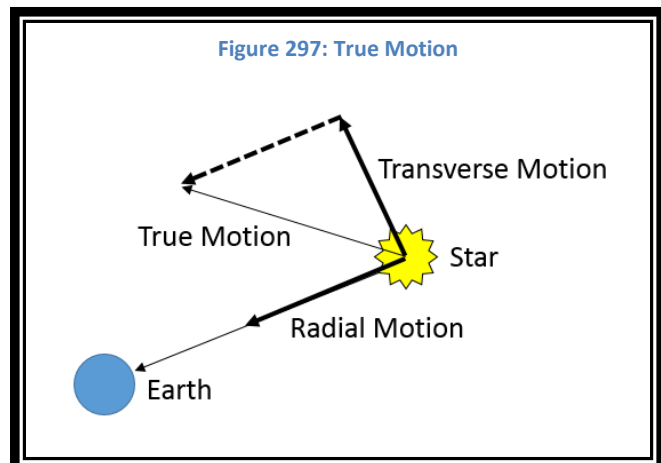
### Radial Motion and Radial Velocity

The other component of a star's motion is either towards us or away from us. This is called **Radial Motion**. This component can be measured using Doppler Shift. The lines in the spectrum of the star will be red-shifted if it is moving away from us, or blue-shifted if it is moving towards us. The amount of the shift tells us the velocity.

### True Motion and True Velocity

The combination of the Radial Velocity and the Transverse Velocity will result in the True Velocity and **True Motion**. This is the actual motion of the star through space.

$$\text{True motion} = \text{radial motion} + \text{transverse motion}$$



## Component 104 – The Luminosity of Stars

Luminosity is a standard characteristic of every star. It is independent of the observer, like its diameter. It is an absolute value and is not changed by the distance of the observer.

### Apparent Brightness

**Apparent Brightness** is how bright a star appears to be for an observer. Since most of our observing is done from Earth, it is how bright a star appears from Earth. If you want to compare how bright an object appears in the sky relative to other objects in the sky to determine if you will be able to see it in your telescope, then this is what is most important to you. The apparent magnitude of the Sun is -26.74

### Absolute Brightness

**Absolute Brightness** is how bright a star actually is. This is calculated as if it were measured from a specific distance. This is the apparent brightness of the star if it were viewed from a distance of 10 parsecs. This scale is useful for defining specific characteristics of a star. The absolute magnitude of the Sun is 4.83.

### Luminosity

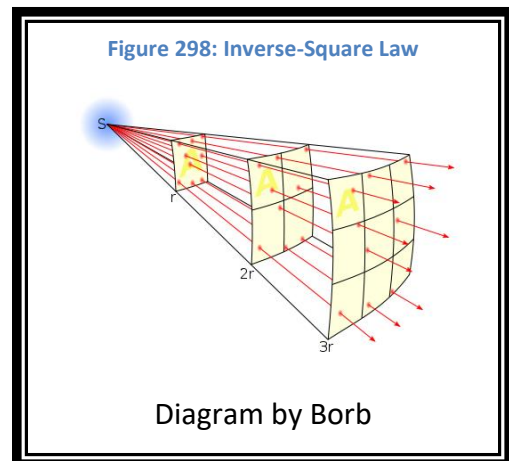
**Luminosity** is the absolute brightness of a star measured in solar units. This gives us a direct way to compare another star with the Sun. The luminosity of the Sun is 1.0

### Apparent Brightness vs. Distance

The brightness of a star will appear differently depending on how far the observer is from the star. Stars of very different luminosities may have the same apparent brightness if they are at very different distances from the observer. This is referred to as the Inverse-Square Law (Equation 14). Since the Luminosity is a constant, if the Distance is doubled, then the Apparent Brightness is reduced to  $\frac{1}{4}$ . The reason for this is that the formula to calculate the area of the surface of a sphere is  $A = 4 * \pi * r^2$ . This is the **Inverse Square Law**.

Equation 14: Inverse-Square Law

$$\text{Apparent Brightness} \propto \frac{\text{Luminosity}}{\text{Distance}^2}$$



## Component 105 – The Temperature of Stars

The surface **temperature** of stars ranges from roughly 3,000 K to over 40,000 K. The color of the star's peak temperature is an indication of its surface temperature. Cooler stars peak in the infrared and they are around 3000 K. A 6000 K star peaks in the yellow, and a very hot star peaks in the ultraviolet and may be 30,000 K.

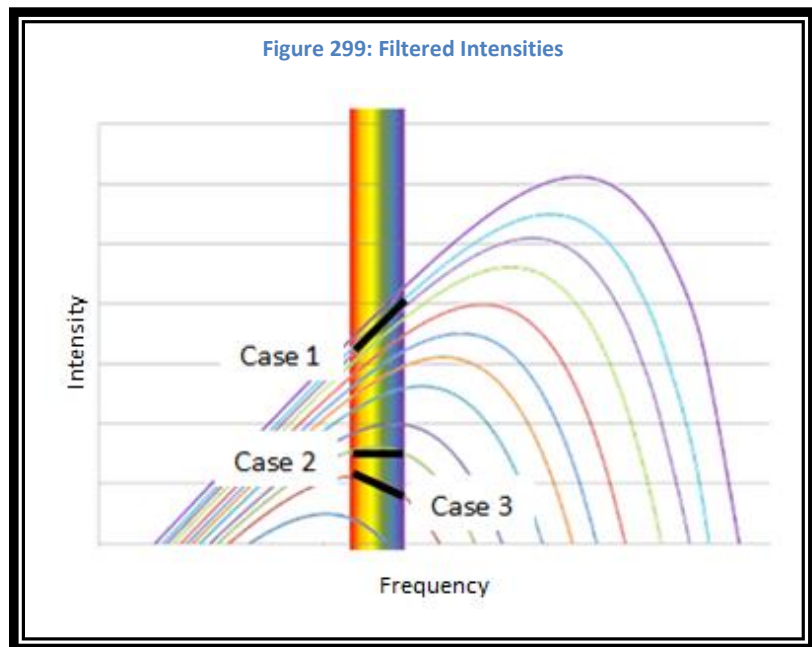
The way that astronomers determine the temperature of a star is to take measurements of the star at very specific frequencies. These points are sufficient to identify which curve represents the star. There is a set of five photometric filters that astronomers can use. They are U (ultraviolet), B (blue), V (visible – green), R (red) and I (infrared).

If the B intensity is greater than the R intensity, this means the peak must be off to the ultraviolet end of the spectrum (Case 1 in Figure 365). This is a very hot star. If they are about equal, this means that the star is peaking in the visible spectrum and is cooler (Case 2 in Figure 365), and if the B is much less than the R then the star is cooler and peaks in the infrared (Case 3 in Figure 365). Table 27 shows the relationship between peak color and stellar surface temperature.

Table 27: Stellar Colors vs. Temperature

Temperature	Color
40,000 K	Blue
20,000 K	Blue-White
10,000 K	White
7,000 K	Yellow-White
6,000 K	Yellow
4,000 K	Orange
3,000 K	Red

*Peak Color of a Star tells you its Surface Temperature*



## Component 106 – Spectral Classification of Stars

### Spectral Classifications

Stars are classified according to their peak color. The Spectral Classes are **O, B, A, F, G, K, and M**. There are also three more classes below M, which are: **L, T, and Y**. The way to remember this is the phrase: “Oh, Be A Fine Girl (or Guy), Kiss Me. Like This? Yes!” This will help you remember what they are and also the order from hottest to coolest. L class stars are stars but they are sub-red dwarfs. Stars in the T class are brown dwarfs, and Y class stars are sub-brown dwarfs. The Sun is a G type star.

The last two classifications: T and Y are not really stars.

They are too small to build up the pressures and temperatures necessary to do Proton-Proton Chain Fusion and are failed stars. They are large enough that they can fuse deuterium into helium, so they are not planets.

These spectral classes are then divided into 10 subclasses numbered from 0 to 9. Subclass 0 is the hottest, and subclass 9 is the coolest. The Sun is a G2 star.

### Spectral Complexity

Hotter stars have simpler spectra than cooler stars.

This is because the increased temperature means that atoms are moving at higher speeds. These atoms tend to smash into molecules and break them apart. Very hot stars tend to have primarily hydrogen and helium spectral lines. As the star temperatures decrease more atoms are present in the spectra, until you get to M stars, where molecules also appear.

Table 28: Spectral Class vs. Temperature

Temperature	Spectral Class
> 30,000 K	O
10,000-30,000 K	B
7,500-10,000 K	A
6,000-7,500 K	F
5,200-6,000 K	G
3,700-5,200 K	K
2,400-3,700 K	M
1,300-2,400 K	L
700 – 1,300 K	T
< 700 K	Y

*Cooler Stars  
Have More  
Complex Spectra*

## Component 107 – The HR Diagram

Two astronomers, Ejnar Hertzsprung and Henry Norris Russell, found that it was useful to plot stars in a chart that has Luminosity on the vertical axis and Temperature on the horizontal axis. The chart is used as a snapshot. It is a picture in time of where a specific population of stars are based on their luminosity and temperature. Remember that Luminosity is in solar units; 1 is the brightness of the Sun. We have also seen that in addition to temperature, the horizontal axis can also show color and spectral class.

### The Basic HR Diagram

Figure 366 shows a number of familiar bright stars as they appear in the appropriate locations on the **HR Diagram**. The vertical axis includes a **Luminosity** scale in solar units as well as the **Absolute Magnitude** scale. The horizontal scale shows the **Spectral Classifications**, the **Color**, and the **Temperature** in K.

Note that there appears to be a line of stars going from the top left to the bottom right (from Mintaka to Proxima Centauri) of which the Sun is a member. We notice that there are a small number of stars below and to the left of this line (Sirius B and Procyon B).

The value of using the HR Diagram is that if we can place a star in the right place on this diagram then we can approximate many of that star's characteristics. In addition to the two axis of the chart, we are able to superimpose more information on the chart.

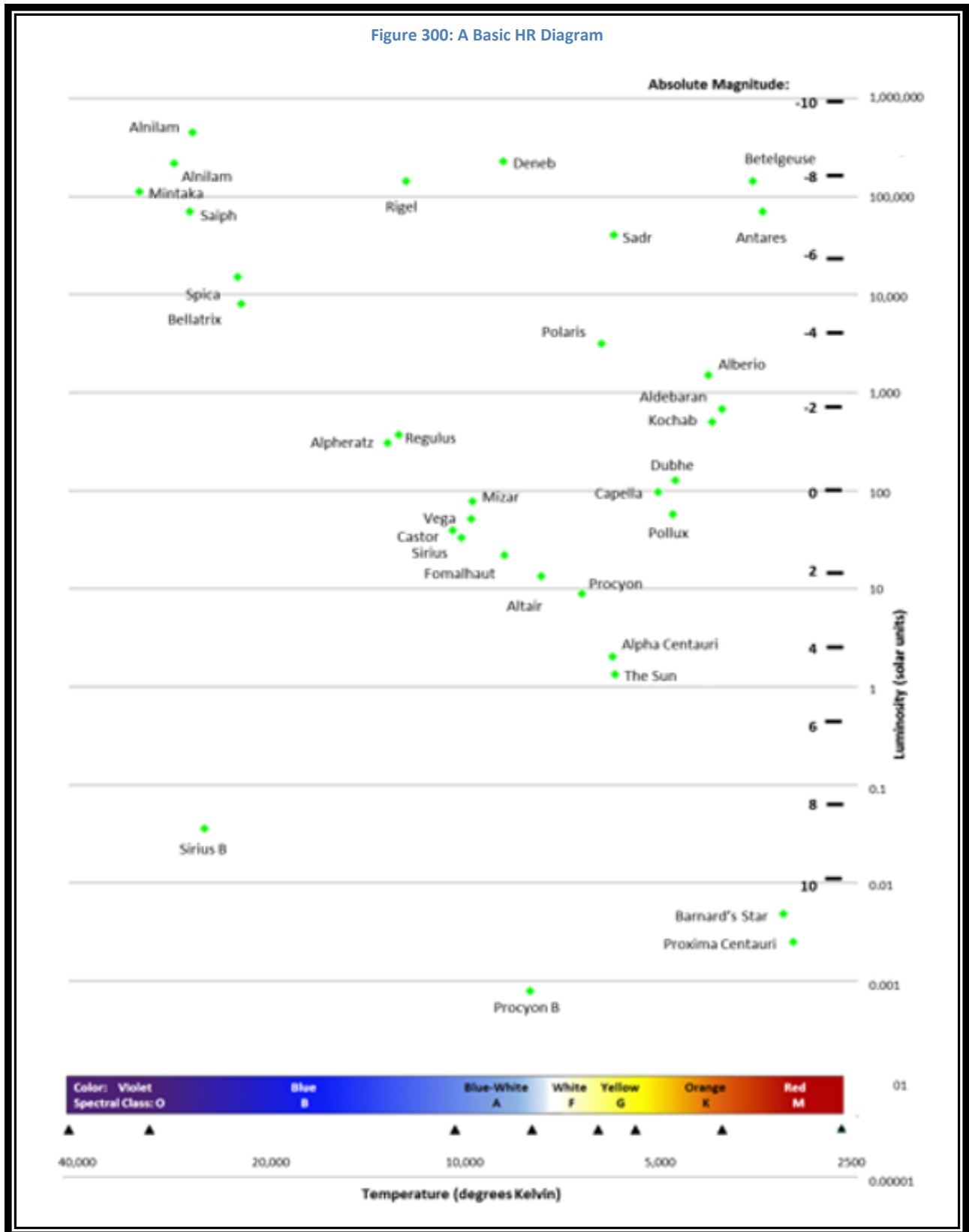
### Spectral Types

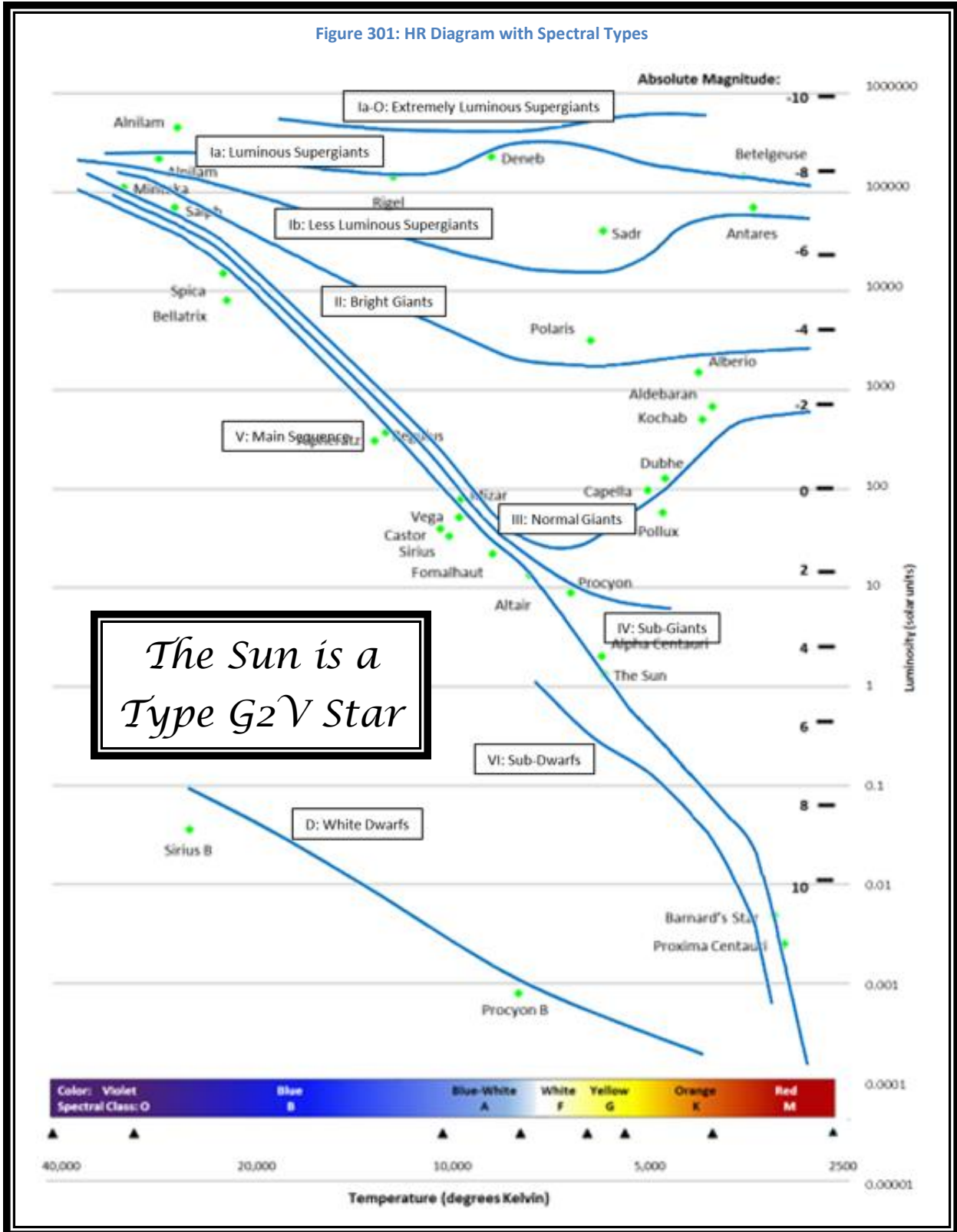
When we plot many stars on the HR Diagram we notice that they fall on paths. These paths are referred to as **Spectral Types**. They are shown in Figure 367 as Roman Numerals I through VI, and there is a type near the bottom for White Dwarf Stars; Type D or VII. There is also a Spectral Type at the top; O for Extremely Luminous Supergiants or Hypergiants. Note that there are two lines for Spectral Type I: Ia – Luminous Supergiants and Ib – Less Luminous Supergiants. Table 29 lists the different Spectral Types and their names.

Table 29: Spectral Types

Type	Name
O	Extremely Luminous Supergiants
Ia	Luminous Supergiants
Ib	Less Luminous Supergiants
II	Bright Giants
III	Normal Giants
IV	Sub-Giants
V	Main Sequence
VI	Sub-Dwarfs
D (or VII)	White Dwarfs

Figure 300: A Basic HR Diagram







## Spectral Regions

Figure 368 is an HR Diagram that shows the regions in which different types of stars can be found. The blue oval at the top is the realm of the Supergiants. The pink oval near the right side is the realm of the Giants. The green oval near the bottom is the realm of the White Dwarfs.

Note that there is a gray band running from the center of the bottom to the top right. This is called the Instability Strip. Stars that are found within this region are not stable stars. They tend to oscillate and include the variable stars. The small purple oval in this region is the realm of the RR Lyrae Variables Stars, and the larger dark yellow oval is the realm of the Cepheid Variable Stars.

Some variable stars are a bit outside of the Instability Strip. The bright yellow oval is the realm of the RV Tauri Variable Stars and the orange oval is the realm of the Mira Variable Stars. Whereas most variable stars are nearing the end of their life, there is one other type that are protostars on their way to becoming stars: T-Tauri Variable Stars. These pre-main sequence stars have not yet initiated fusion. The reddish oval is the realm of the T-Tauri Stars.

## Stellar Mass and Radii

Another use for the HR Diagram is to show the location of stars of different stellar sizes (or radii) as well as the mass for stars along the Main Sequence. The small black boxes along the Main Sequence (Stellar Type V) in Figure 369 represent stars of different solar masses. The red diagonal lines represent stars of different solar radii or solar **diameters**.

Although there are stars much heavier than the 20 solar masses shown near the top of the Main Sequence, they are not shown on this diagram.

The largest stars known have a radius that is over 1500 times that of the Sun (solar radii). If our Sun were to become a star this size, the surface of the Sun, the photosphere, would extend beyond the orbit of Jupiter (out to almost 7 AU).

The most massive star known is 265 times the **mass** of the Sun (solar masses). Very massive stars are quite rare. They tend to have very short lifetimes and therefore there are very few of them in existence in the observable neighborhood.

Figure 302: HR Diagram with Regions

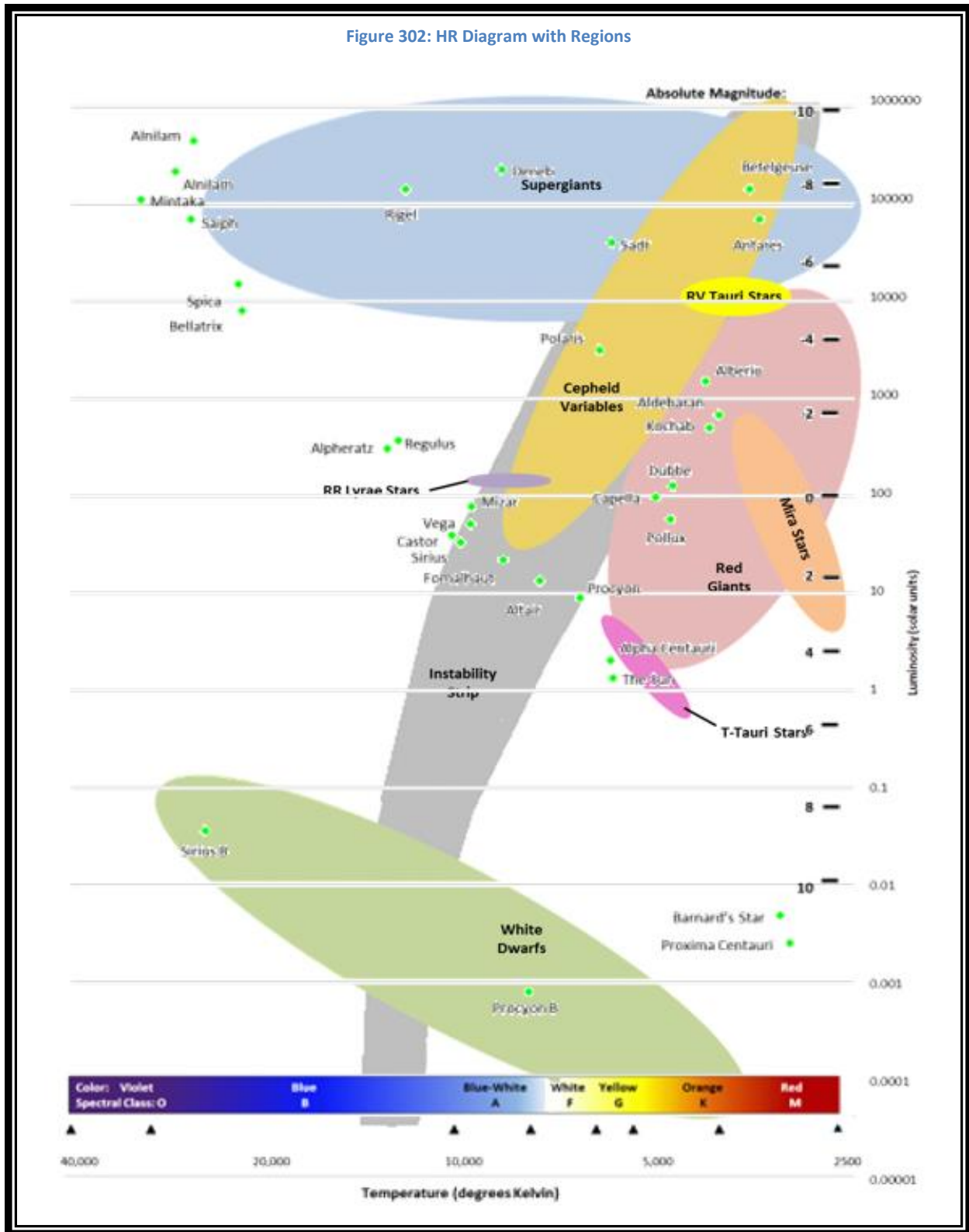
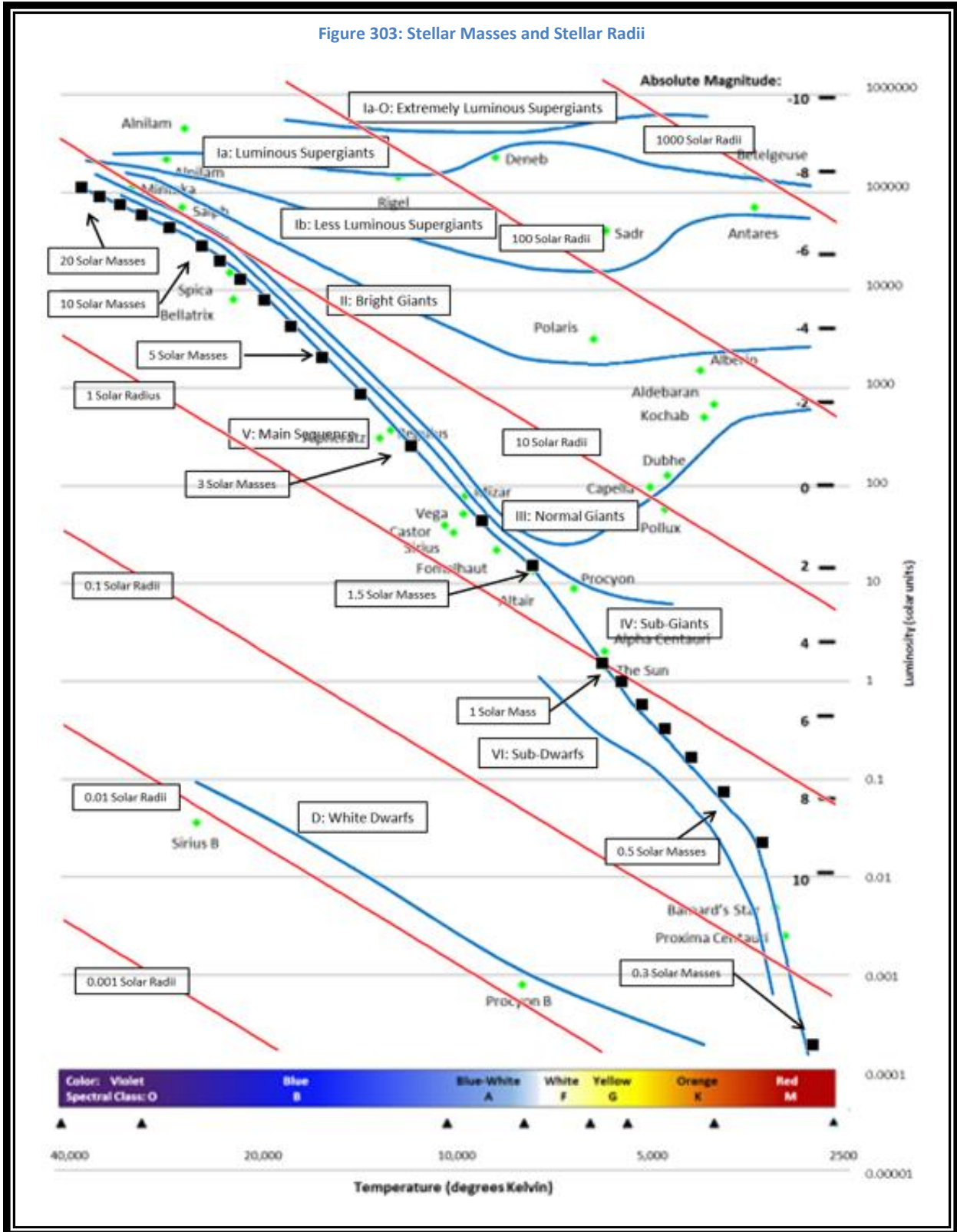


Figure 303: Stellar Masses and Stellar Radii



## Component 108 – The Sizes of Stars

### Dwarf Stars

The stars in the HR Diagram come in many sizes. All stars on the Main Sequence on the HR-Diagram are considered **Dwarf Stars**. This is also true of all stars below the Main Sequence. Note that the blue stars on the Main Sequence could be 10 times larger than the Sun, and the Red Dwarfs can be as small as 1/10 the size of the Sun, but they are all considered dwarfs.

### Giant Stars

All stars above the Main Sequence are considered to be **Giant Stars**. These can range in size from 10 to 1000 times the size of the Sun. Some of these stars are considered Supergiants and even Hypergiants.

### Calculating the Size of a Star

The size of a star can be calculated if we know its Luminosity and Temperature. Temperature can be measured spectroscopically and the Luminosity can be estimated from the HR-Diagram. The equation uses Luminosity in Watts, Radius in kilometers, and the Temperature in K.

The relationship is shown in Equation 15. If we use solar units; L is solar luminosities ( $3.9 * 10^{26}$  Watts), R is solar radii ( $6.96 * 10^5$  km), and T is solar temperatures (5,800 K), then the equation becomes much simpler and is shown in Equation 16

Equation 16: Size in Solar Radii


$$R = \frac{\sqrt{L}}{T^2}$$

Equation 15: Calculating Stellar Size

$$L = 4\pi\sigma R^2 T^4 \text{ or}$$
$$R = \sqrt{\frac{L}{4\pi\sigma T^4}}$$

## Component 109 – Special Members of the Stellar Family

Some members of the stellar family are not really stars. The Dwarf Stars (Red through Violet), the Giant Stars, and the Supergiant Stars are all really stars. The definition of a star is that it must have fusion of Hydrogen into Helium occurring within its core.



*A Star Fuses  
Hydrogen into  
Helium*

### White Dwarfs

**White Dwarfs** are not the white stars that occur on the Main Sequence. White Dwarfs are the remnants of former stars. Stars that are the size of the Sun or smaller, when they run low on fuel for their fusion reactions, will result in the formation of a compressed core of the star. It will be made of Hydrogen, Helium, and sometimes Carbon. These embers are the superhot cores of the former stars, radiating their heat into space until they reach the same temperature of the surrounding space. White Dwarfs are found in the bottom left of the HR Diagram. A White Dwarf is the collapsed core of a star. Gravity has caused the electrons to be so tightly packed that they are pushed up against each other. This is called the **Electron Degeneracy Pressure**. The upper limit of the mass of a White Dwarf stellar remnant is 1.4 solar masses and is called the Chandrasekhar Limit.

### Black Dwarfs

**Black Dwarfs** are the endpoint of a White Dwarfs' life. After the White Dwarf has cooled to the temperature of local space, it will no longer be glowing at any frequencies. The Universe is not old enough to have any Black Dwarfs at this time.

### Brown Dwarfs

Some of the time, as stars are forming out of the interstellar medium, there is not enough mass available. The material forms into the shape of a star, but its gravity is insufficient to create the temperatures and pressures required for nuclear fusion of hydrogen. If they are too small, they will become planets like Jupiter. But there is an intermediate size as well. One of the things that was formed in the Big Bang was deuterium. This element is really a form of hydrogen but its nucleus, in addition to the proton, has a neutron as well. A **Brown Dwarf** has enough mass to create the pressure and temperature needed to fuse this deuterium into helium. This partial fusion process differentiates the Brown Dwarfs from the Planets.

## Astronomy for Mere Mortals – An Introductory Astronomy Text

One challenge facing astronomers is: When an object is discovered orbiting a distant star, is it a large planet, or is it a Brown Dwarf? There is some overlap in their masses based on the materials in the star's composition.

## Component 110 – The Sun’s Childhood

All stars start life as large clouds of dust and gas in space. As the material condenses into stars, the stages that the star progresses through vary based on the amount of mass available to each star. We will start by looking at the process of the development of the Sun, or stars like the Sun, from the dust cloud to the main sequence.

Table 30: The Sun's Childhood Stages

Stage	Core Temperature	Surface Temperature	Diameter	Length of Time	Name
1	10 K	10 K			Dust Cloud
2	10 K	10 K	$1 \cdot 10^{14}$ km	$2 \cdot 10^6$ yr	Fragmentation
3	10,000 K	100 K	$1 \cdot 10^{10}$ km	$1 \cdot 10^5$ yr	Condensation
4	5,000,000 K	4000 K	$1 \cdot 10^7$ km	$1 \cdot 10^7$ yr	Protostar
5	10,000,000 K	4500 K	$2 \cdot 10^6$ km	$3 \cdot 10^7$ yr	Star
6	15,000,000 K	6000 K	$1.5 \cdot 10^6$ km	$1 \cdot 10^{10}$ yr	Main Sequence

### Stage 1: Dust Cloud

The first stage of a star’s life is a dust cloud. This cloud is stable and in equilibrium. It could exist in this state for a very long time. Something disturbs the calm state of the cloud, and pieces begin to collapse. This could be the end of a large star’s life - a Supernova, or it could even be a shockwave from the birth of a nearby star. Once the matter in the cloud has been disturbed, the state of equilibrium in the cloud is lost and the cloud begins to collapse and fragment due to its own gravity. These clouds are so large that many stars form out of the same dust cloud at approximately the same time.

Figure 304: Dust Cloud: The Horsehead Nebula



Figure 305: Dust Cloud Fragmentation



### Stage 2: Dust Cloud Fragmentation

The **diameter** of the fragment that would be used to make a Sun-like star would be approximately  $1 \cdot 10^{14}$  km. As these regions collapse due to gravity, the cloud fragments into smaller clouds. To get to

the next stage in the star's life takes approximately two million years. The density of matter in these dust clouds is quite low. There may be as little as  $1 \times 10^5$  particles per cubic centimeter (cc). It appears that star formation involves the creation of hundreds to thousands of stars from a single dust cloud. Initial fragments are then broken up into smaller fragments as the process continues. Each star is formed from one of the small fragments. These are also known as Bok Globules.

### **Stage 3: Fragment Condensation**

Once the dust cloud has broken up into fragments, the individual fragments continue to collapse due to gravity. The material is now about 1000 times denser than it was in the original dust cloud. Initially, the material is able to radiate

*The Protostar for a Sun-Like Star is 100 times bigger, and 1000 times brighter than the Star*

energy from the collapse out into space, but as the density increases it will reach a point where it is difficult for the energy to escape. At this point the temperature of the fragment will increase. By the end of this stage, the fragment has condensed to the size of our solar system. The **temperature** continues to rise as does the density in the core of the fragment. Its density is now a billion times more than the original dust cloud. At the end of this stage, the material has condensed to the point where it is forming into a ball; a Protostar.

### **Stage 4: Protostar**

A Protostar of a Sun-like star is still approximately 100 times the diameter of the Sun, and it is 1000 times more luminous. This is also the stage where its rotation would become obvious. As the matter collapses due to gravity, it will begin to rotate with the sum of the motions of all of the particles in the original cloud. As it shrinks, the rotation speed will increase due the Law of Conservation of Angular Momentum.

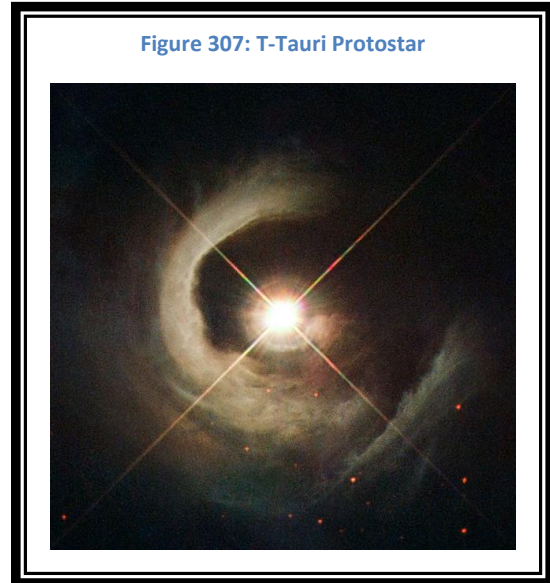
Figure 306: A Protostar



Although the central star is beginning to form, there is still a disk of material surrounding the protostar that is 100 AU in diameter. An image of a Protostar was taken by NASA in infrared using the Spitzer Space Telescope.



We can now show where a Sun-like Protostar would appear on the HR Diagram. The Protostar stage is represented by the yellow line in Figure 374. Although an HR Diagram does not show the progress of a star throughout its life, we can use it to show where the different stages in a star's life would be on the diagram. The Protostar stage is also where strong stellar winds begin to form. Initially they would be blowing outward from the poles of the axis of rotation. But over time, as the collapse continues, the protostellar winds would radiate outward in all directions. The latter part of a Protostar's evolution, where the protostellar winds are being emitted, is called the T-Tauri Phase. An image taken by NASA showing the stellar winds of a T-Tauri Protostar is in Figure 373. It is clear in the image that the strong winds are blowing the dust and gas of the cloud outward and away from the Protostar.



### **Stage 5: Star**

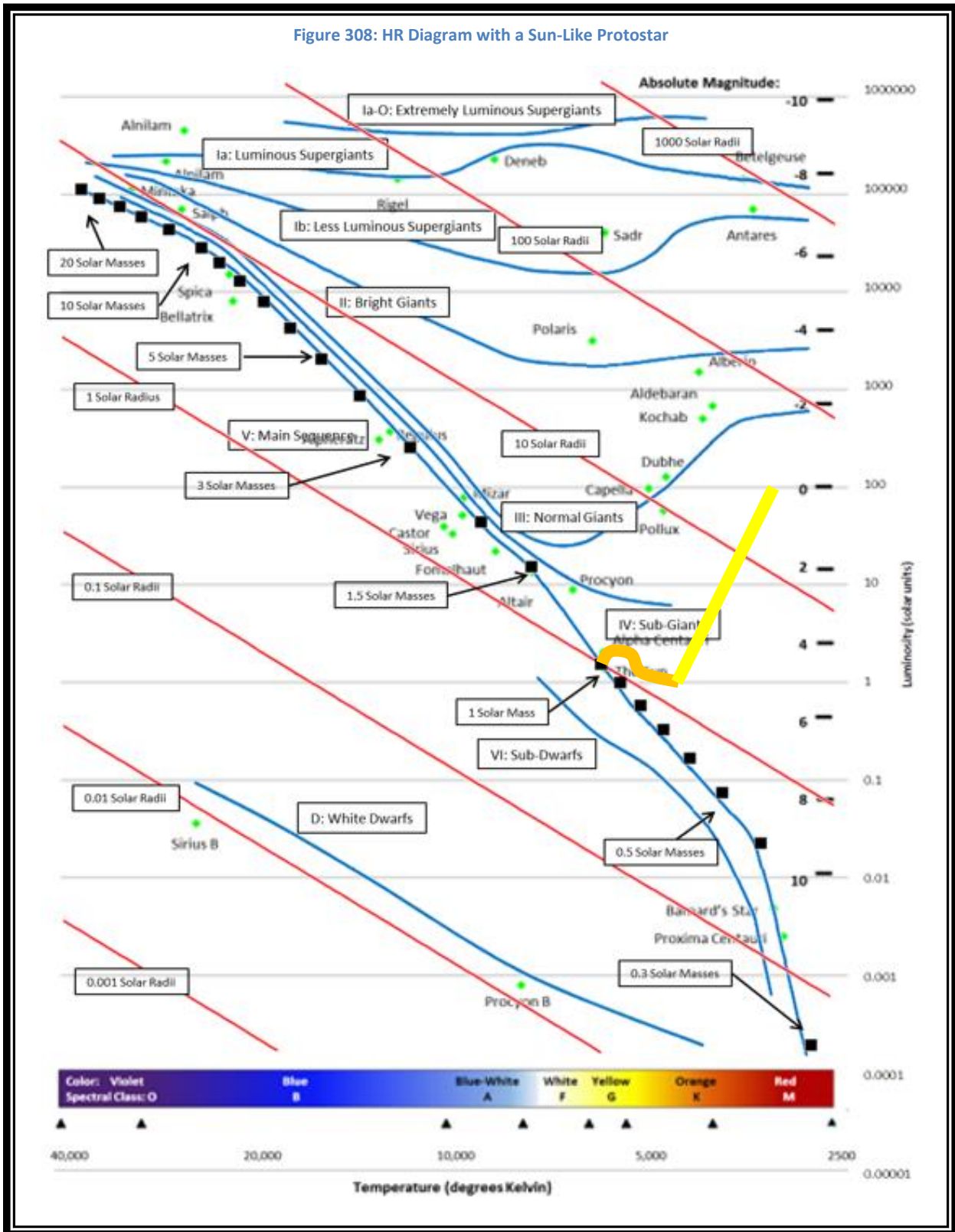
Once the material has collapsed enough, there will be high enough pressure and temperature in the core for hydrogen fusion to begin. This is the point where the collapsing dust cloud becomes a star. The star has not reached equilibrium at this point. This stage is represented by the orange line in Figure 374.

### **Stage 6: Main Sequence**

At the end of the stage as a Star, our dust cloud has evolved to the point where it is stable and has reached hydrostatic equilibrium. This is the point where it becomes a Main Sequence Star. This is the stage in which our Sun is currently. For a Sun-like star this stage is approximately 10 billion years long. This is the stage where the star is powered by hydrogen fusion and is making helium. This helium sits in the center of the core and accumulates throughout this stage. This is represented by the left end of the orange line in Figure 374. The Sun has been in this stage for about 5 billion years.

*The Sun is about 5 Billion Years Old*

*The Sun will be on the Main Sequence for about 10 Billion Years*



## Component 111 – The Sun’s Elder Years

After spending the majority of their lives on the Main Sequence, all stars eventually run low on fuel. Their path to “the end” and what that end looks like depends on the mass of the stars. We will start by looking at the process for the end-stages of the life of the Sun, or stars like the Sun, from the Main Sequence to a Black Dwarf.

**Table 31: The Sun's Elder Year Stages**

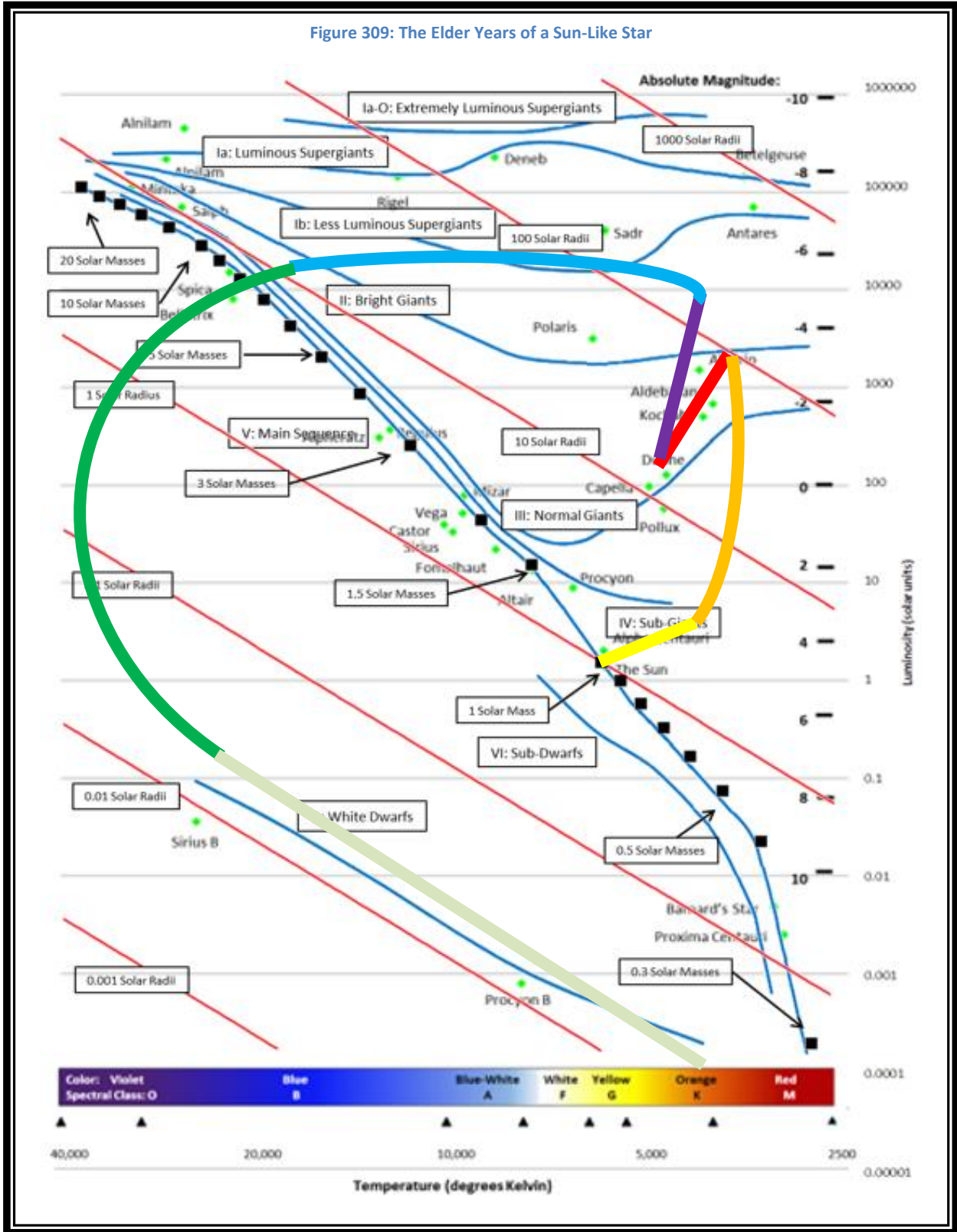
Stage	Core Temperature	Surface Temperature	Diameter	Length of Time	Name
6	15,000,000 K	6,000 K	$1.5 \cdot 10^6$ km	$1 \cdot 10^{10}$ yr	Main Sequence
7	50,000,000 K	4,000 K	$4.0 \cdot 10^6$ km	$1 \cdot 10^8$ yr	SubGiant Branch
8	100,000,000 K	4,000 K	$1.4 \cdot 10^8$ km	$1 \cdot 10^5$ yr	Red Giant Branch
9	200,000,000 K	5,000 K	$1.4 \cdot 10^7$ km	$5 \cdot 10^7$ yr	Horizontal Branch
10	250,000,000 K	4,000 K	$8.0 \cdot 10^8$ km	$1 \cdot 10^4$ yr	Asymptotic Giant Branch
11		3,000 K	$1.4 \cdot 10^9$ km	$1 \cdot 10^5$ yr	Planetary Nebula
12	100,000,000 K	50,000 K	$2.0 \cdot 10^4$ km		White Dwarf
13	0 K	0 K	$2.0 \cdot 10^4$ km		Black Dwarf

Figure 375 shows the path a Sun-like star will follow once it leaves the Main Sequence.

### **Stage 7: The SubGiant Branch**

As a Sun-like star begins to run low on hydrogen, the pressure necessary for hydrostatic equilibrium is reduced. The star will then collapse. As it collapses, the temperature and pressure increases. As the star continues to use hydrogen the collapse process accelerates. To initiate helium fusion, the temperature in the core needs to reach 100 million K. The evolution of the star is shown in Figure 375 as the yellow line leaving the Main Sequence. The diameter of the star is increasing during this stage, but without additional fusion in the core, the surface temperature drops. Overall the luminosity remains about the same. This is the Sub-Giant Branch. The star will expand to about 3 times the diameter of the Sun.

Figure 309: The Elder Years of a Sun-Like Star



### **Stage 8: Red Giant Branch**

In the next stage, the helium core continues to collapse. The core gets hotter and hotter, and this additional heat generates more pressure on the star's outer layers. These layers respond by expanding and cooling. The primary process for moving energy from the core to the surface transitions to convection. The star's material is no longer transparent to photons. This is the orange line in Figure 375. By the end of this stage, the Sun-like star has enlarged to about the diameter of Mercury's orbit.

*At this Point, Mercury  
is Inside the Sun*

In the realm of classical physics, the core would continue to shrink and pressure would continue to rise, but electrons can only be squeezed to a point. Quantum

Mechanics states that you reach a point where the electrons are tightly packed and there is no more space to squeeze out. This state is referred to as Electron Degeneracy. At this limit, the electrons are pushing back separately from the thermal pressure in the core. This outward pressure is called the Electron Degeneracy Pressure. All of the electrons have been forced into their lowest possible energy state. Once the temperature has reached the necessary limit of 100 million K, the helium in the core will begin to fuse using the Triple Alpha Process to make carbon. With the onset of helium fusion, with the core in this degenerate state, the additional temperature demands do not increase the pressure. The helium core becomes unstable. The temperature rises quickly and the pressure remains fairly constant and this causes the fusion rate to also increase rapidly.

At the end of this stage, the helium fusion goes out of control and there is a massive helium fusion event called the **Helium Flash**. Over a timespan of a few hours, helium fuses at an incredible rate and heats the core to the point where the thermal pressure surpasses the Electron Degeneracy Pressure and the core expands. The star is now able to return to hydrostatic equilibrium. The star shrinks and its luminosity drops. The surface temperature increases and the star moves on to the next stage, the Horizontal Branch. This is the red line in Figure 375.

During this branch there are very strong stellar winds and approximately a quarter of the star's mass may be lost through those winds.

### **Stage 9: The Horizontal Branch**

The star's position on the horizontal branch depends on the remaining mass of the star. The more massive the star is at this point, the cooler the surface temperature and the larger the

diameter of the star. Helium fusion happens rapidly, and as the fuel supply declines, the core again begins to collapse and the star moves into the Asymptotic Giant Branch.

### **Stage 10: The Asymptotic Giant Branch**

More pressure leads to higher temperatures and more rapid fusion. The star then follows the purple line in Figure 375, the Asymptotic Giant Branch. During this phase the helium supply continues to diminish and the core continues to collapse. The size of the star increases and the luminosity increases as the surface temperature decreases a little. The core collects more and more carbon. At the end of this stage, you have a non-burning core of carbon surrounded by a shell of burning helium, which in turn is surrounded by a burning shell of hydrogen. Outside of these layers, the non-burning hydrogen has puffed out to an even larger red giant star.

A Sun-like star is not massive enough to have the gravity necessary to increase the pressure and temperature in the carbon core high enough to ignite carbon fusion. The core will contract to the point where electron degeneracy limits the

*At this Point, Mars  
is Inside the Sun*

contraction. But before new fusion can ignite, the existing fusion drops to a level where the outward pressure can't sustain the size of the star. The core temperature is up to 300 million K. Some carbon fusion will occur along the outer edge of the carbon core, but in general the engine in the core of the star is shutting down.

### **Stage 11: The Planetary Nebula**

At the end of the purple line in Figure 375, the next stage begins. The star has expanded out to the diameter of Mars's orbit. At this point the fusion in the outer layers of the core continues at a very high rate, the outer shell of hydrogen continues to expand, but the outward pressure from fusion has diminished. At this point the layers of the core become unstable.

The helium shell experiences large and rapid changes in helium fusion causing explosions in the layer. These create much energy that moves into the outer shell of hydrogen, which then expand rapidly. This happens repeatedly and each expansion is larger and more violent than the previous one. This culminates in one large pulse that effectively blows off the outer layers of the star into space leaving the central carbon core. The outer layers expand outward as a Planetary Nebula. This material is expanding away from the core at a speed of tens of kilometers per second and expands out beyond the orbit of Neptune. The carbon core is a Carbon White Dwarf which will cool until it reaches the temperature of the surrounding space and becomes a Black Dwarf.

## Component 112 – The Lives of Small Stars

Low-mass stars, those smaller than the Sun will have different life paths than Sun-like stars. Each stage of a low-mass stars life is longer than the Sun-like stars.

### Small Star Childhood

The time required for a Sun-like star to evolve to the Main Sequence Stage is measured in tens of millions of years. For a small red dwarf star, this childhood takes billions of years. This means that many objects that are destined to be small red dwarf stars have not had enough time to reach the Main Sequence yet.

The evolution of a small star prior to it reaching the Main Sequence is the same stages that a Sun-like star passes through. Protostar through Main Sequence is shown in Figure 376 as a yellow and then orange line respectively.

### Small Star Main Sequence

Once on the Main Sequence, a small red dwarf star will live a quiet stable life fusing hydrogen into helium for trillions of years. This means that all red dwarf stars that have formed are still red dwarf stars. The Universe has not existed long enough for them to have left the main sequence.

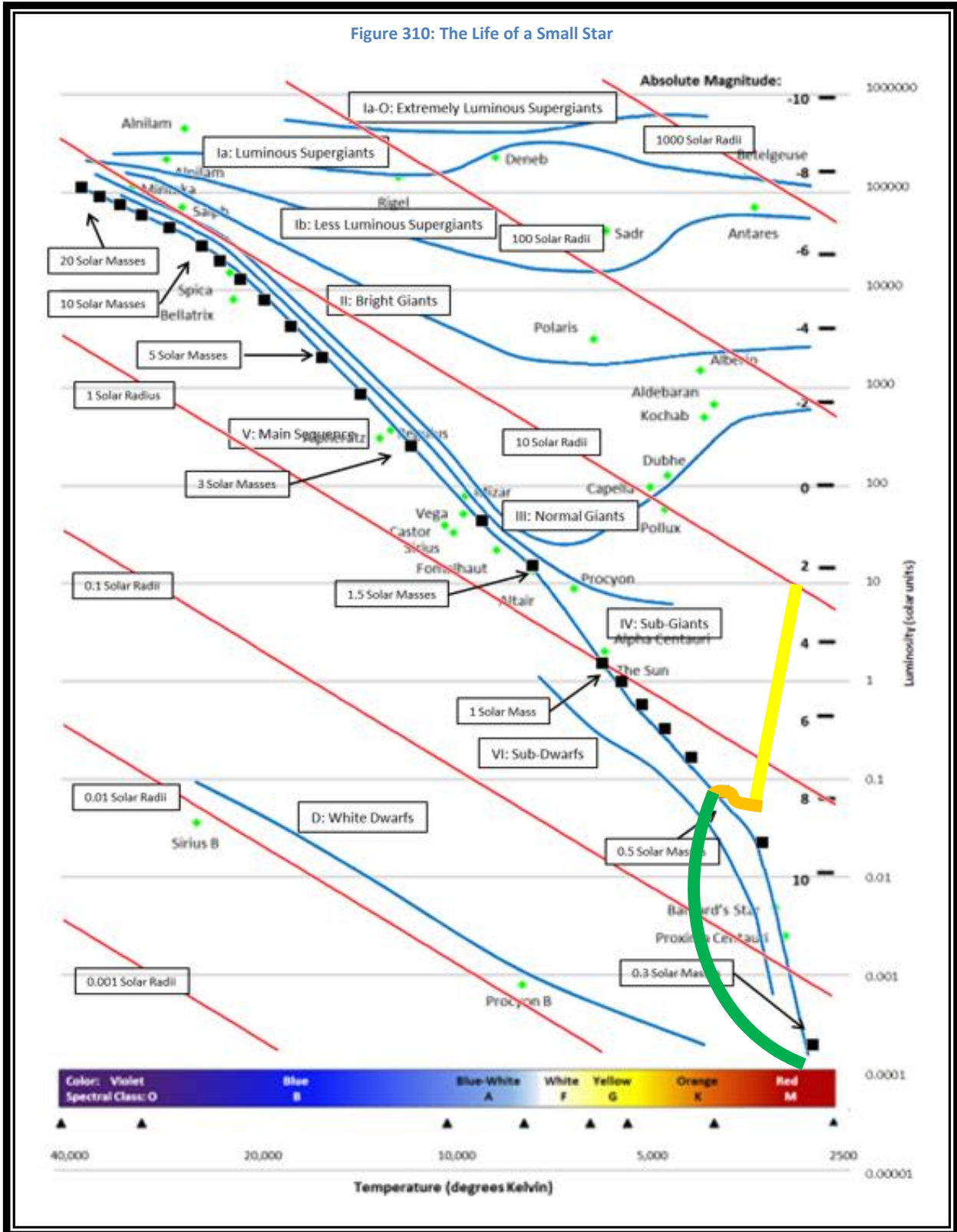
### Small Star Elder Years

As a red dwarf star begins to run low on hydrogen fuel, it will collapse. But, they do not contain enough matter for their gravity to be strong enough to build up the temperatures and pressures in their cores needed to begin helium fusion. Red dwarf stars will shrink until the electrons in the helium will not let gravity collapse the star further. At this point the star progresses from a Main Sequence Star to the White Dwarf Stage. There are no explosions or violent actions. The star becomes an ember cooling to the temperature of the local dust and gas. The transition to White Dwarf is the green line in Figure 376.

Table 32: A Low Mass Star's Life

Stage	Name
1	Dust Cloud
2	Fragmentation
3	Condensation
4	Protostar
5	Star
6	Main Sequence
7	White Dwarf
8	Black Dwarf

Figure 310: The Life of a Small Star





## Component 113 – The Lives of Larger Stars

As stars become larger, the time spent in each stage of their lives becomes shorter. Stars that are higher mass than the Sun, also have more complex lives after the Main Sequence.

### Pre-Main Sequence for Large Stars

The pre-Main Sequence lives of Stars larger than the Sun are shown by the light blue (3 solar mass), blue (9 solar mass), and violet (15 solar mass) lines in Figure 377. Smaller stars are shown for reference as the red (0.5 solar mass) and yellow (1 solar mass) lines.

The path to the Main Sequence becomes more direct and more horizontal for large stars. For small and Sun-like stars the luminosity drops significantly moving from protostar to the Main Sequence. For large stars, the change in luminosity is a minor drop, and as the stars are larger, there is actually an increase in luminosity as they move from protostar to the Main Sequence.

Note that this part of a star’s life (from Protostar to the Main Sequence) is shorter for larger mass stars. Red Dwarf Stars will take 150 million years to traverse this part of the process. Sun-like stars can do it in 50 million years. But three-solar-mass stars will make it to the Main Sequence in only three millions years. Nine solar mass stars only take 150,000 years, and large, 15 solar mass stars only require 60,000 years.

### Main Sequence for Large Stars

Very large stars may leave the Main Sequence after as little as 10 million years. Large stars may leave the Main Sequence after 100 million years.

### Post-Main Sequence for Large Stars

When large stars leave the Main Sequence there is no Helium Flash. Helium starts fusing as the temperature and pressure reach the levels required. Figure 378 shows the path of large stars (in blue) and shows sun-like stars (yellow) and red dwarf stars (red) for comparison. Large stars follow a path that repeatedly crosses the diagram as new stages of **alpha fusion** occur (dotted blue) until **Iron** is formed. At this point there is a **Supernova** explosion and the remnant will be either a **Neutron Star** or a **Black Hole**.

Table 33: A High Mass Star's Life

Stage	Name
1	Dust Cloud
2	Fragmentation
3	Condensation
4	Protostar
5	Star
6	Main Sequence
7	Helium Fusion
8	Heavy Element Fusion
9	Supernova
10	Neutron Star / Black Hole

Figure 311: Pre-Main Sequence Evolution of Stars

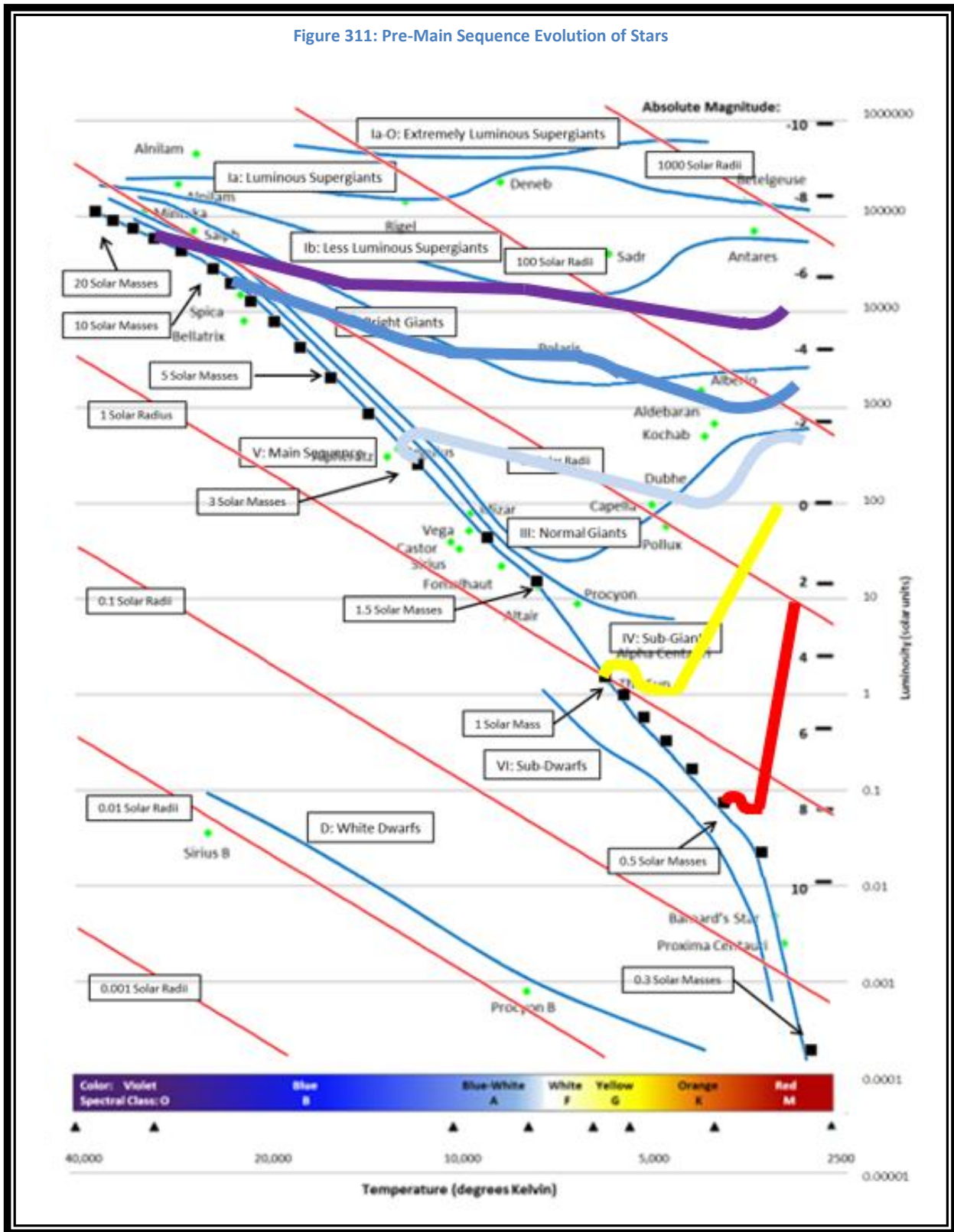
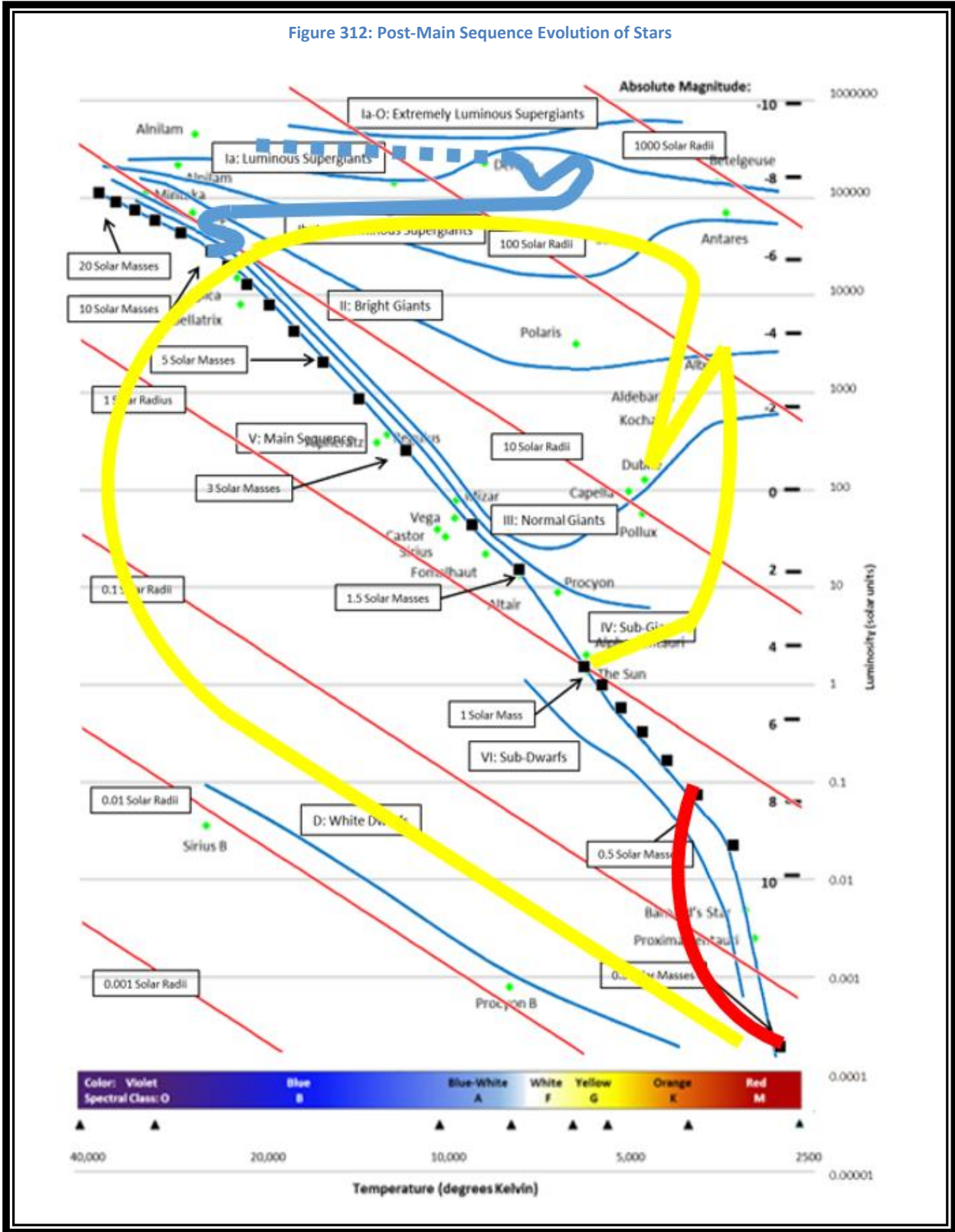


Figure 312: Post-Main Sequence Evolution of Stars



## Component 114 – Time on the Main Sequence

The Main Sequence is where stars spend the majority of their lives. But the time they spend there is directly related to their mass. As the size of the star increases, the gravity increases. This gravity squeezes the core and greater gravity means higher temperatures and pressures. The rate at which hydrogen fusion occurs is directly related to the core temperature and pressure. This means that smaller stars tend to burn their hydrogen very slowly, whereas very large stars will burn their hydrogen at a much faster rate.

Red Dwarf stars, the smallest stars, will burn their hydrogen for **trillions** of years.

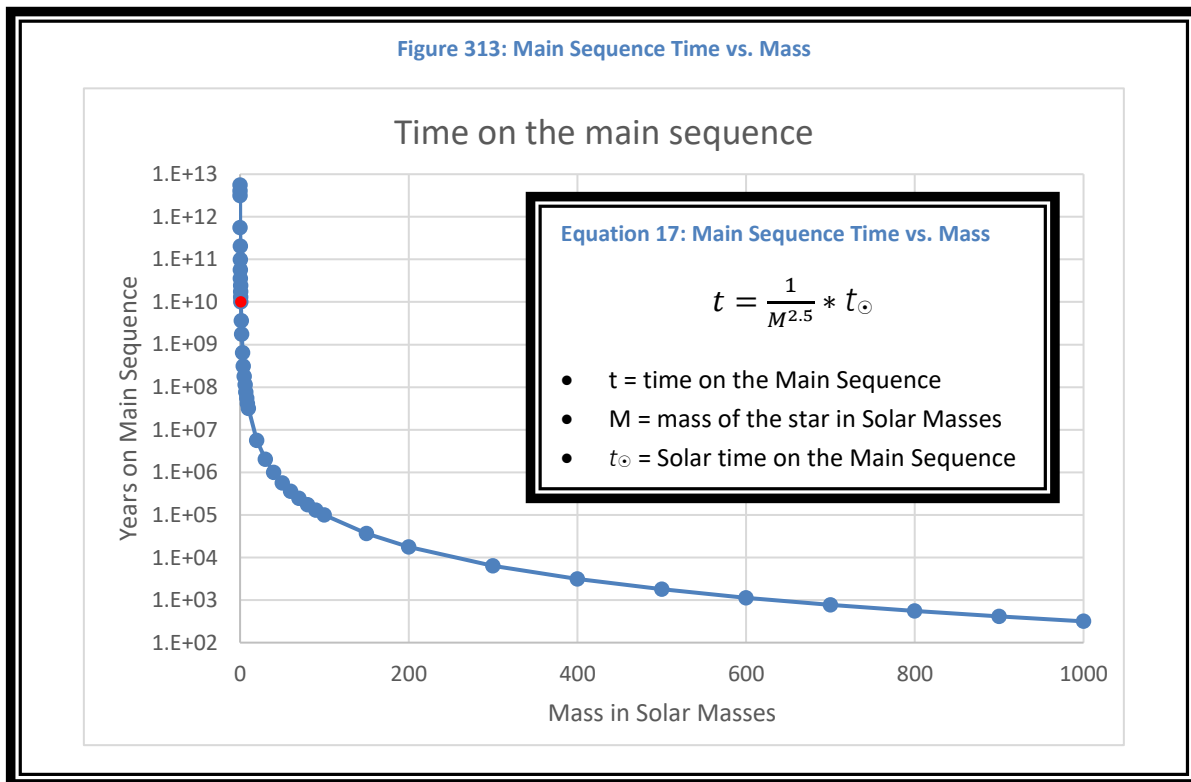
A yellow dwarf, like the sun, will burn its hydrogen for about **10 billion** years.

A large blue dwarf will burn most of its hydrogen, even though it has much more, in a very short time, only **millions** of years.

Table 34: Stellar Lifetime vs. Mass

Mass ( $M_{\odot}$ )	Time on Main Sequence
0.1	Trillions of years
1	10 billion years
1.5	3 billion years
3	650 million years
10	32 million years
30	2 million years
60	360 thousand years
150	36 thousand years

Figure 313: Main Sequence Time vs. Mass



## Component 115 – End States for Different Mass Stars

As the last few components show, different mass stars will have very different endpoints. There is some variation in what different astrophysicists believe the lines are between the different endpoints, but this component presents a reasonable picture of the endstates.

### Endstate as a Function of Remnant Mass

The endstate is specifically a function of the mass of the stellar remnant, not the original star's mass. When a star creates a supernova or a planetary nebula, much of the mass moves away into space. The mass that is left is the stellar remnant. Table 35 shows the endstate that you will have based on the mass of the stellar remnant. Two stars with the same initial masses may have very different remnant masses.

Table 35: Remnant Mass vs. Stellar End States

Mass of the Remnant in Solar Masses	End State
< 1.4	White Dwarf
1.4 to 3	Neutron Star
> 3	Black Hole

Figure 314: Initial Mass vs. Stellar End States

Mass of the Star in Solar Masses	Approximate Mass of the Remnant	Initial State	End State
< 0.08	< 0.08	Brown Dwarf	Brown Dwarf
0.08 to 0.5	0.08 to 0.5	Type M Star	Helium White Dwarf
0.5 to 8	0.2 to 3.7	Type K, G, and F Type Stars	Planetary Nebula and Carbon/Oxygen <b>White Dwarf</b>
8 to 15		Type B and A Stars	Supernova and <b>Neutron Star</b>
> 15		Type O Star	Supernova and <b>Black Hole</b>
	1.4	Carbon White Dwarf in a Binary System receiving material	Carbon Detonation Supernova and no remnant

## Component 116 – Fusion in Large Stars' Cores

Sun-like stars will only do fusion until they have a core of carbon. This point is the end of the stars life as a star. Proton-Proton Chain Fusion was discussed in Component 102 but stars larger than the Sun have enough mass to create pressures and temperatures necessary to do a different type of hydrogen fusion; the **CNO Cycle Fusion**.

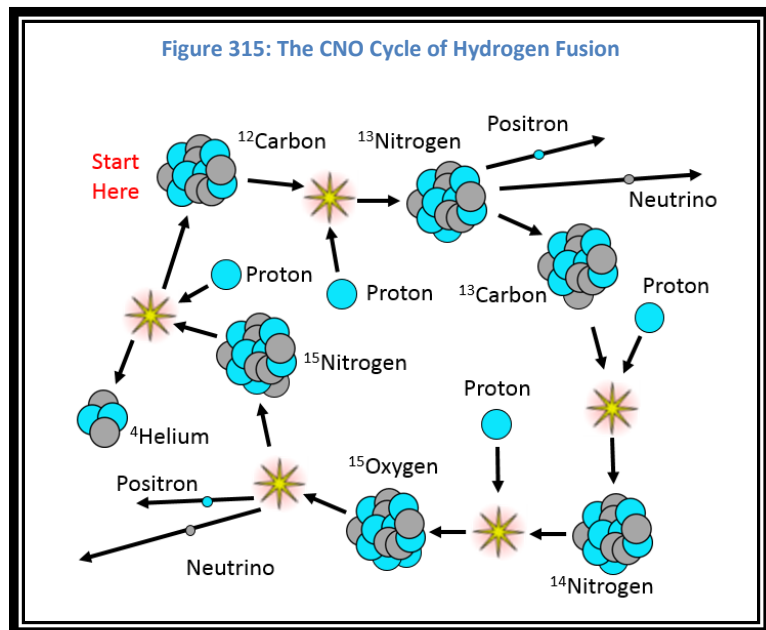
### CNO Cycle

For a star to do the CNO Cycle, there are some requirements:

1. The star must be larger than the Sun.
2. The star must have enough carbon in its core to initiate the CNO Cycle.

Stars in the universe today have enough matter from previous stars to have the heavy elements, specifically carbon, which they need to the CNO Cycle.

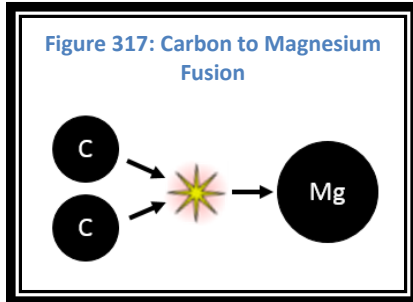
The CNO Cycle starts with a  $^{12}\text{C}$  nucleus and adds protons to the nucleus. If the resultant nucleus is stable then another proton is added. If the nucleus is unstable it will decay and the process will continue. When the process reaches  $^{15}\text{N}$ , the addition of another proton will release a helium nucleus and you are left with the  $^{12}\text{C}$  with which you started the process.



### The Alpha Fusion Process

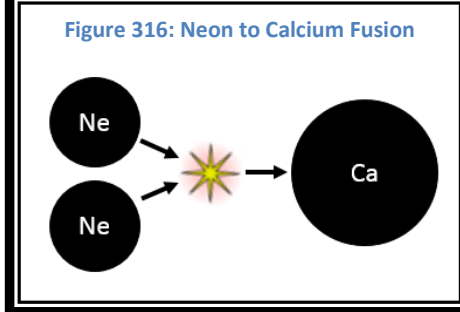
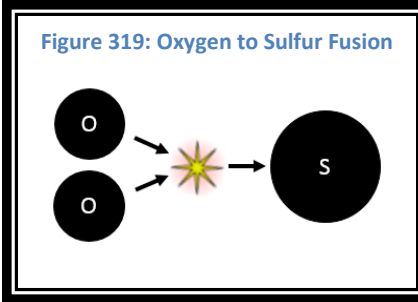
As a large star begins to run low on hydrogen to fuel the CNO Cycle, the core will begin to collapse. When this happens, the pressure and temperature increases until other forms of fusion can occur. The most common process is the Alpha Process. It involves repeatedly adding helium nuclei to the nucleus to create new elements (see Figure 386).

Other forms of fusion can also occur as higher temperatures and pressures are reached.



Two  $^{12}\text{C}$  nuclei can fuse together and form  $^{24}\text{Mg}$  (Figure 383).

Two  $^{16}\text{O}$  nuclei can fuse together to form  $^{32}\text{S}$  (Figure 385).



Two  $^{20}\text{Ne}$  nuclei can fuse together to form  $^{40}\text{Ca}$  (Figure 382).

Two  $^{24}\text{Mg}$  nuclei can fuse together to form  $^{48}\text{Cr}$  (Figure 384).

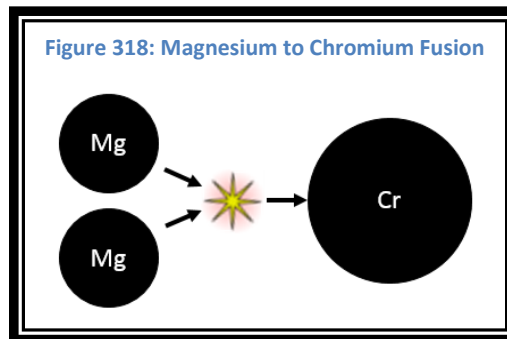
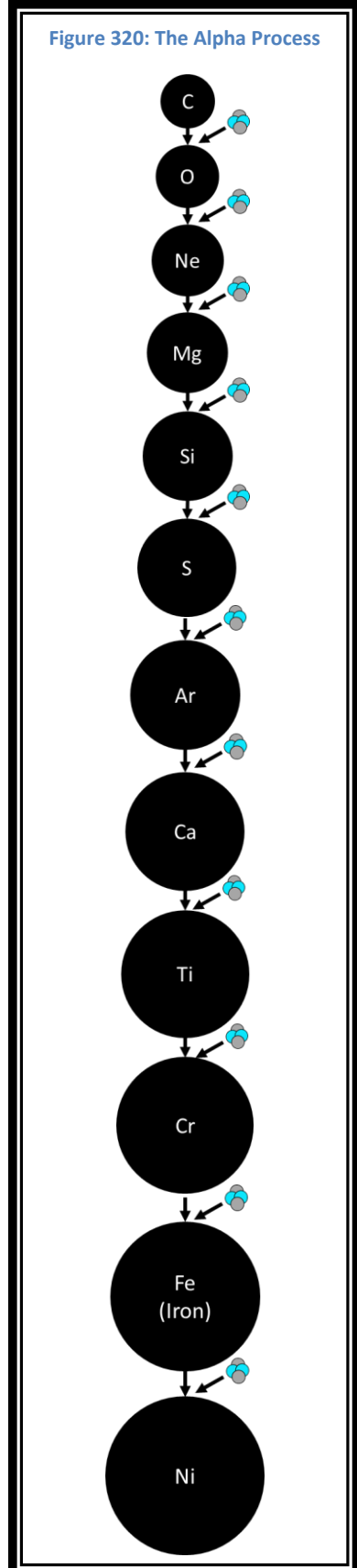
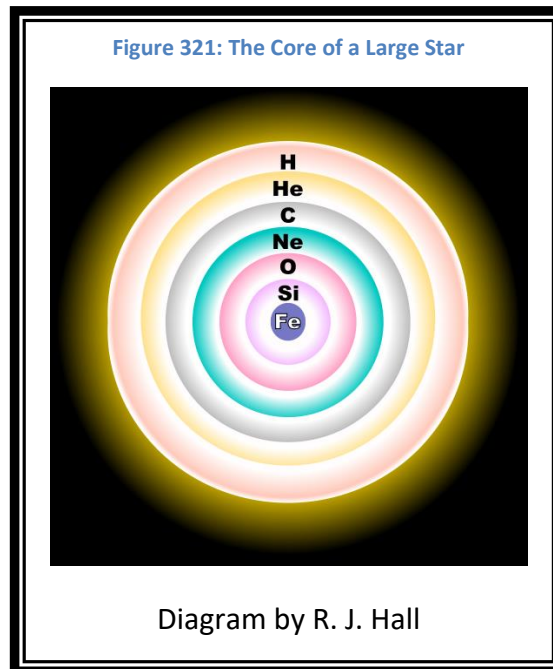


Figure 387 shows the multiple layers in a large star's core prior to the supernova event. This is referred to as the Onion Model.



### The End of the Fusion Road in the Core

The process stops when nuclei of Nickel are formed. This reaction removes more energy from the process than it generates. Up to this point the fusion reactions resulted in more energy being generated than was used to make the reaction occur.

*The elements through Iron are made through the Alpha Process*

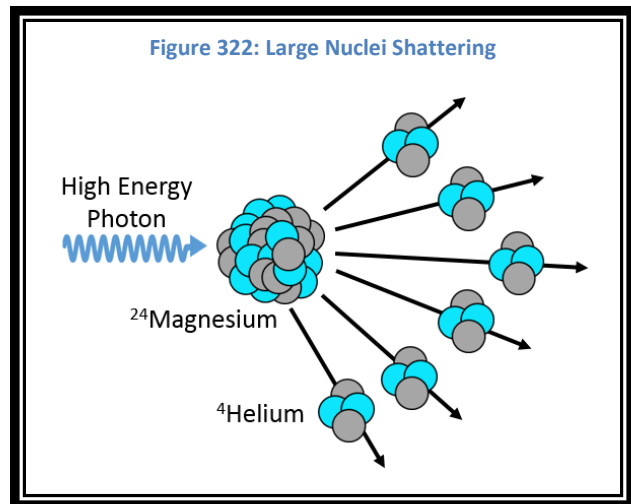
Iron, because it is the most stable element of them all, actually uses more energy when it is fused with a helium nucleus than it generate in the process. This means that energy is being removed from the core. As this happens, the core cools and it is more difficult to do fusion.

$^{56}\text{Ni}$  is not stable, and with a half-life of 6.075 days, it decays into  $^{56}\text{Co}$ . This form of cobalt is also unstable and decays into  $^{56}\text{Fe}$ . The cobalt has a half-life of 77.223 days. This form of iron is stable.

### Photodisintegration

Although the star has been creating helium nuclei from protons in the core, there are other processes that help increase the number of helium nuclei available for the Alpha Process.

Large nuclei can be shattered by high energy photons. The result is the protons and neutrons are released as helium nuclei (see Figure 388). These helium nuclei are then available to fusion reactions in the Alpha Process to build other heavy nuclei.



This shattering of heavy nuclei can occur with any nucleus. The result is a balance between the creative processes and the destructive processes as the star continues to use up the fuel in its core. The destructive process is called **Photodisintegration**: the destruction of heavy nuclei by high-energy **photons**. It creates **helium** nuclei as well as free **neutrons** and **protons**.

*Photodisintegration is the destruction of heavy nuclei by energetic photons*



## Component 117 – Temperatures for Core Fusion

Each fusion reaction in the core of a star requires a minimum temperature. The heavier the element being created, the more energy required and therefore the higher the temperature required.

**Table 36: Fusion Temperatures**

Fusion Process	Minimum Temperature (K)
Proton-Proton Chain	$4 * 10^6$
CNO Cycle	$1.5 * 10^7$
P-P Chain → CNO Cycle	$1.7 * 10^7$
Triple- Alpha	$1 * 10^8$
Carbon	$5 * 10^8$
Neon	$1.2 * 10^9$
Oxygen	$1.5 * 10^9$
Silicon	$2.7 * 10^9$

**Deuterium Fusion** can occur when the core temperature reaches  $1 * 10^6$  K

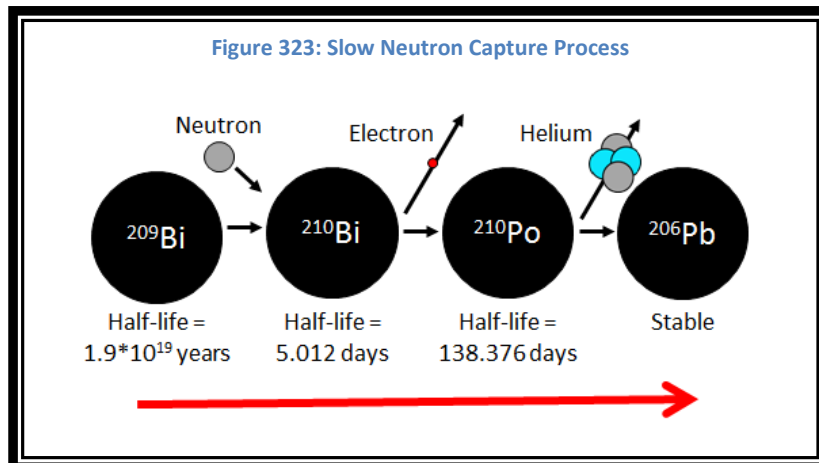
Fusion of Iron into Nickel requires a core temperature of zinc using the Alpha Process may occur, but the high temperatures in the star's core produce photons with such high energies that larger atoms are destroyed quickly through photodisintegration

## Component 118 – Fusion in the S-Process

In addition to fusion occurring in the core through the Alpha Process creating elements up to Iron, there is another process occurring as the star is reaching the end of its life. The **S-Process**, or the **Slow Neutron Capture Process (Slow Process)**, will create elements up to **Bismuth**.

Free neutrons in the core of stars are available to combine with nuclei to generate heavier isotopes of the existing atoms. When an unstable isotope of an atom is reached, and when there is insufficient time for another **neutron** to combine with the nucleus before it decays, the nucleus will become the isotope of the previous element with roughly the same mass. On average, the S-Process operates at an average neutron capture rate of one per **year**. When the nucleus decays the neutron capture process can continue.

For example, at the upper limit for this process, bismuth is created. There are no stable isotopes of bismuth, but  $^{209}\text{Bi}$  has a **half-life** of  $1.9 \cdot 10^{19}$  years which is almost stable. The S-Process will have the reactions on  $^{209}\text{Bi}$  shown in Figure 389.



The S-Process creates a path through the elements and with isotopes that is a zig-zag. Neutrons are added until an unstable isotope decays. This usually results in an electron being emitted by the nucleus and the atom being changed to one with the next lower atomic number. Neutrons are again added to the nucleus until the result is an unstable isotope. Then the cycle repeats.

The S-Process occurs in the core of stars as the heavier elements are being formed by the Alpha Process.

*The S-Process occurs in the core at the same time as the Alpha Process*

## Component 119 – Fusion in the R-Process

At the end of a large star’s life, as the supernova is occurring, there is another fusion process that occurs. It is called the **R-Process**, or the **Rapid Process of Neutron Capture (Rapid Process)**. The process is very similar to the S-Process. Neutrons are captured by the nucleus until it becomes unstable and decays. The difference is that the R-Process requires less time for each successive neutron capture. Rather than a rate of one neutron capture per year (as in the S-Process), the R-Process proceeds at an average rate of one neutron capture per **second**. This means that more isotopes are stable enough to permit the process to continue to higher-mass nuclei before decay occurs.

*S-Process = 1  
neutron per year*  
*R-Process = 1  
neutron per second*

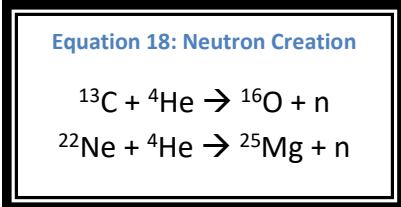
The upper limit to this process is **Uranium**. Although there are isotopes of elements more massive than uranium that are stable enough for the R-Process to function, there is another roadblock that occurs. As a nucleus grows, there is greater stress on the Strong Force to hold the protons together in the nucleus. Additional neutrons in the nucleus help strengthen the Strong Force, but at the size of Uranium the Strong Force is no longer able to cope with the Electromagnetic Force. The protons are then unable to stick to the nucleus and higher mass atoms are not possible.

*S-Process makes  
atoms to Bismuth*  
*R-Process makes  
atoms to Uranium*

### Source of the Neutrons

To create elements by the Slow and Rapid Neutron Capture processes there must be an adequate supply of neutrons. The most common processes to create neutrons are shown in Equation 18. These two processes can begin once a sufficient supply of <sup>13</sup>Carbon or <sup>25</sup>Magnesium is available to supply the raw materials for the

nuclear reaction. These are not the forms of these elements that are created in the Triple-Alpha and Alpha processes, but are the results of other nuclear reactions occurring in the core of large stars.



## Component 120 – Magnitudes and Luminosities

### Apparent Magnitudes

Looking at the stars, we see them as they appear to us. This is called their Apparent Magnitude. Two identical stars will appear differently if they are at different distances. When we measure the brightness of stars using photometry we measure this Apparent Magnitude.

### Magnitude Scale

The **Magnitude** Scale is designed such that the larger the number (in the positive direction) the fainter the star. Each step in magnitude represents a change of 2.5 times the brightness. For example a magnitude 2 star is 2.5 times fainter than a magnitude 1 star.

### What We See

The limit of the magnitude of the faintest object you can see is a function of the equipment you are using.

Sirius is the brightest star in the nighttime sky. It has an Apparent Magnitude of -1.5. All other stars are fainter and therefore have larger (positive) Apparent Magnitudes.

Table 37: Apparent Magnitudes

	Magnitude
<b>Hubble Telescope</b>	30
<b>Large Backyard Telescope</b>	15
<b>10 x 50 Binoculars</b>	10
<b>Naked Eyes</b>	6
<b>Sirius</b>	-1.5
<b>Crescent Venus</b>	-4.4
<b>Full Moon</b>	-12.5
<b>The Sun</b>	-26.7

*Using Just Your  
Eyes You Can See  
to Magnitude 6*

### Absolute Magnitude

*Binoculars Can  
See Magnitude 10*

An object's Absolute Magnitude is a standard way to compare the brightness of objects. This is the Apparent Magnitude you would see if you were at a distance of 10 parsecs from the objects.

*Typical Large Backyard  
Telescopes Can See Magnitude 15*

**Luminosity**

**Luminosity** is another standard way to compare the brightness of objects. Rather than using the magnitude scale, it compares an object’s brightness to the Absolute Magnitude of the Sun. The Sun’s Absolute Magnitude is 4.83. (This is how bright it would appear if you were 10 parsecs away.)

Equation 19: Luminosity vs. Absolute Magnitude

$$L = 10^{\left(\frac{M-4.83}{2.5}\right)}$$

L = Luminosity (solar units)  
M = Absolute Magnitude

**Number of Stars by Apparent Magnitudes**

Table 38: Star Numbers vs. Apparent Magnitudes

Magnitude	Number of Stars	Total Number of Stars
-1	2	2
0	6	8
1	14	22
2	71	93
3	190	283
4	610	893
5	1,929	2,822
6	5,946	8,768
7	17,765	26,533
8	51,049	77,582
9	140,062	217,644
10	409,194	626,838
11	1,196,690	1,823,528
12	3,481,113	5,304,641
13	10,126,390	15,431,031
14	29,457,184	44,888,215
15	85,689,537	130,577,752
16	249,266,759	379,844,511
17	725,105,060	1,104,949,571
18	2,109,295,881	3,214,245,452
19	6,135,840,666	9,350,086,118
20	17,848,866,544	27,198,952,662

As the magnitudes get fainter we see significantly more stars. Table 38 shows the number of stars that are visible for magnitudes -1 through 20. Although there are almost 18 billion more stars visible when you move from magnitude 19 to magnitude 20, note that there are only 8 more stars visible as you move from magnitude -1 to magnitude 0.

The last column of the table shows the total number of stars visible at each magnitude. For naked-eye observing, with a limit of magnitude 6, there are a total of 8,768 stars visible. Binoculars, able to see magnitude 10, increase that number to 626,838 stars.

For a typical large backyard telescope (magnitude 15 limit) the number explodes to over 130 million stars are visible.

## Component 121 – Data on Spectral Types

Spectral Types are O, B, A, F, G, K, M.

### M Type Stars

Red Dwarfs are stars of Spectral Type M. They range in mass from 0.6 solar masses to 0.075 solar masses and 2,300 K to 3,800 K respectively. These are the smallest stars. Smaller than this is the Brown Dwarf, and it is not capable of hydrogen fusion. Larger stars are Orange Dwarfs.

### K Type Stars

Orange Dwarfs are stars of Spectral Type K. They range in mass from 0.6 solar masses to 0.8 solar masses and temperatures from 3,800 K to 5,300 K respectively. These are small stars. Smaller than this are the Red Dwarfs and larger stars are the Yellow Dwarfs.

### G Type Stars

Yellow Dwarfs are stars of Spectral Type G. The Sun is among the G type stars. These stars range from 0.8 to 1.2 solar masses and temperatures from 5,300 to 6,000 K respectively. Smaller stars are Orange Dwarfs and larger stars are Yellow-White Dwarfs.

### F Type Stars

Yellow-White Dwarfs are stars of Spectral Type F. These stars range from 1.0 to 1.4 solar masses and temperatures from 6,000 to 7,600 K respectively. Smaller stars are Yellow Dwarfs and larger stars are White Dwarfs.

### A Type Stars

White Dwarfs are stars of Spectral Type A. These stars range from 1.4 to 2.1 solar masses and temperatures from 7,600 to 11,500 K respectively. Smaller stars are Yellow-White Dwarfs and larger stars are Blue-White Dwarfs. These should not be confused with the White Dwarfs that are stellar remnants.

**Table 39: M Class Star Characteristics**

Spectral Type	Mass	Radius	Luminosity	Temp
	(M <sub>☉</sub> )	(R <sub>☉</sub> )	(L <sub>☉</sub> )	(K)
M0V	60.0%	62%	7.20%	3,800
M1V	49.0%	49%	3.50%	3,600
M2V	44.0%	44%	2.30%	3,400
M3V	36.0%	39%	1.50%	3,250
M4V	20.0%	26%	0.55%	3,100
M5V	14.0%	20%	0.22%	2,800
M6V	10.0%	15%	0.09%	2,600
M7V	9.0%	12%	0.05%	2,500
M8V	8.0%	11%	0.03%	2,400
M9V	7.5%	8%	0.02%	2,300

### **B Type Stars**

Blue-White Dwarfs are stars of Spectral Type B. These stars range from 2 to 16 solar masses and temperatures from 10,000 to 30,000 K respectively. Smaller stars are White Dwarfs and larger stars are Blue Dwarfs.

### **O Type Stars**

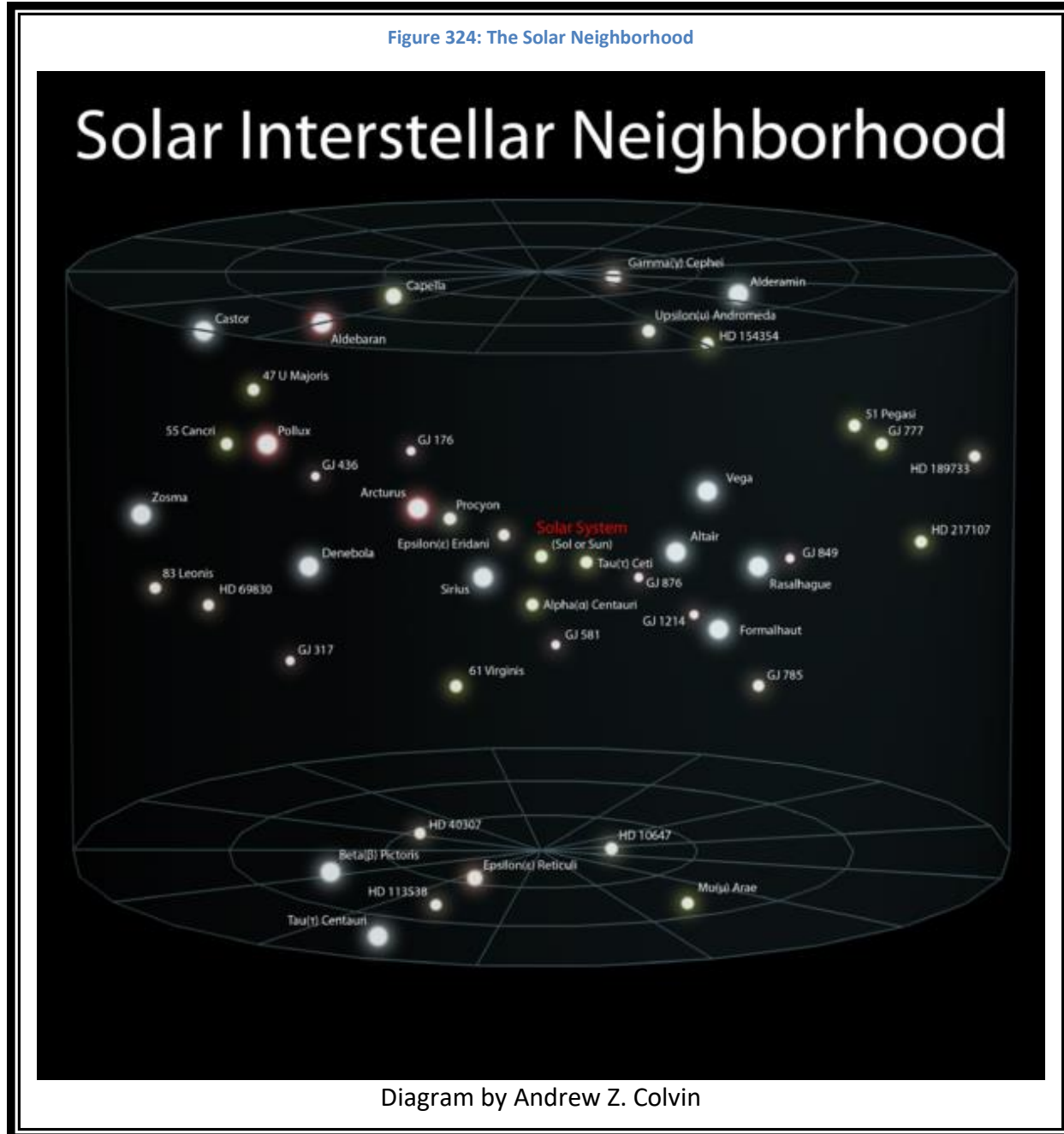
Blue Dwarfs are stars of Spectral Type O. These are the largest stars. They range 15 or more solar masses and temperatures are over 30,000 K respectively. Smaller stars are Blue-White Dwarfs. The largest O Type stars are believed to be approximately 250 solar masses.

*Some star facts for Main Sequence stars:*

- *The bigger the star, the hotter the surface temperature.*
- *The bigger the star, the bluer the star.*
- *The bigger the star, the shorter its life.*
- *The bigger the star, the fewer the stars of that type.*
- *Most of a star's life is spent on the Main Sequence.*
- *All Red Dwarfs ever created, are still Red Dwarfs.*
- *No White Dwarf stellar remnants have evolved to be Black Dwarfs.*

## Component 122 – Stars in the Local Neighborhood

The stars in the Sun's local neighborhood are shown in Figure 390.





## Astronomy for Mere Mortals – An Introductory Astronomy Text

These are among the brightest stars in the nighttime sky. They include:

<b>Star</b>	<b>Constellation</b>
<b>Altair</b>	Aquila the eagle
<b>Capella</b>	Auriga the charioteer
<b>Arcturus</b>	Bootes the herdsman
<b>Sirius</b>	Canis Major the big dog
<b>Procyon</b>	Canis Minor the little dog
<b>Alpha Centauri</b>	Centauri the centaur
<b>Castor</b>	Gemini the twins
<b>Pollux</b>	Gemini the twins
<b>Denebola</b>	Leo the lion
<b>Vega</b>	Lyra the harp
<b>Fomalhaut</b>	Pisces Austrinus the southern fish
<b>Aldebaran</b>	Taurus the bull

## Component 123 – Stellar Distributions

There are many more low mass stars than there are high mass stars.

There are two reasons for this difference:

1. As stars form from a dust cloud, fragmentation would need to stop early enough to leave fragments that are massive enough to form the blue dwarf stars.
2. Larger stars have shorter lives than smaller stars. All of the Red Dwarfs that ever formed still exist as Red Dwarfs. There has not been enough time for them to use up their fuel and to become White Dwarf Remnants. Blue Dwarfs live relatively short lives. Within a few hundred million years a Blue Dwarf will have created iron in its core and become a neutron star or black hole as a result of a supernova explosion.

Looking at the data in Table 40, it is apparent that 88% of the stars in the galaxy are smaller than the Sun. Most stars are Red Dwarfs.

Table 40: Stars by Mass

Mass ( $M_{\odot}$ )	Population %
< 0.25	41%
0.25 to 0.5	28%
0.5 to 1	19%
1 to 2	8%
2 to 4	3%
4 to 8	0.8%
8 to 20	0.3%
> 20	0.06%

*Most stars are  
Red Dwarfs*

## Component 124 – Stellar Populations

In the 1940s, astronomers began studying stars in the galactic halo. They observed that there were far fewer heavy metals (anything heavier than helium) in the stars in the halo than there were in the stellar neighborhood and in the rest of the galactic disk. They termed the disk stars with high metallicity as **Population I**. Those stars of the halo, with less metallicity, were termed **Population II** stars.

### Population I Stars

The current generation of stars is formed from dust clouds that have been seeded with heavy elements from prior supernovae explosions. These stars have a larger amount of heavy metals in their spectra. The Sun is a Population I star.

*The Sun is a  
Population I  
Star*

### Population II Stars

In the halo are older stars. These stars show some metallicity but it is significantly less than the stars in the disk, the Population I Stars. These stars also formed from a dust cloud with elements from prior supernovae explosions, but the lower concentrations of heavy elements means the clouds had fewer prior supernova. But these Population II stars have too high a concentration of heavy metals to have been formed from the primordial dust cloud.

### Population III Stars

Although none have been seen, there is a theory that there should be another population of stars, **Population III**, those that formed from the primordial dust cloud. This dust cloud would have been formed from the materials of the Big Bang. This would have been hydrogen and helium, with only trace amounts of lithium and beryllium.

*We Have  
Never Seen a  
Population III  
Star*

The leading theory of why we have not seen any Population III Stars is that stars made of only hydrogen and helium would be very large stars. They would likely have been between 60 and 300 solar masses, and they would have formed in the very early universe. Very massive stars live relatively short lives in the range of 10s to 100s of millions of years. Any Population III stars that formed would have long since reached the end of their lives and today would be neutron stars or black holes. To see these stars from the early universe, our telescopes would need to be able to see individual stars that are over 13 billion light-years away. This would be quite a feat, and we may never be able to see Population III Stars.

## Component 125 – Interstellar Dust and Gas

When we look at galaxies or within our own galaxy we see that there are great expanses of dust and gas. These clouds are matter that is not currently in stars or other objects. It is mostly hydrogen and helium, but does have heavy elements as well. The gas is composed of atoms and molecules and is not very dense. The dust is more like smoke. It contains many different molecules and atoms that have collected together.

### The Shape of the Dust

By observing light that has passed through dust clouds, astronomers know that the dust particles are shaped like **rice**, long and thin, but very much smaller. The light passing through some of these clouds is partially polarized. This means the dust must be long and thin, and also somewhat aligned in the same direction. The currently accepted theory is that there is a weak magnetic field. This would help explain why the particles are aligned.

*Interstellar Dust is  
the Shape of Rice*

### The Density of Interstellar Dust

Dust and gas are everywhere. Even in the vacuum of space, there are still dust and gas. The average concentration of interstellar gas is only 1,000,000 atoms per cubic meter, and ranges from 1,000 to 1,000,000,000 atoms per cubic meter. There is only an average of 1000 dust grains per cubic kilometer. This is not very dense, but space is dirty. Over the vast distances of empty space the number of dust grains adds up and it is possible to have so much dust between the Earth and the object we are trying to see that the object is not visible.

### Composition of Interstellar Dust

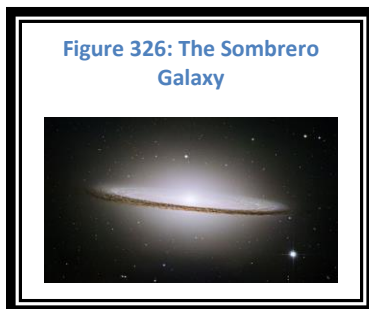
By studying the light that passes through dust clouds it is possible to determine the composition of those dust clouds. Absorption Lines are visible in the spectra of those stars. Which dark lines are present tells astronomers which elements are present in the cloud.

The gas seems primarily to be made of hydrogen and helium with other elements and molecules in small portions. The dust seems to be a collection of the atoms and molecules in the gas. There seems to be some water ice, silicates, iron, ammonia, and methane.

*Interstellar Gas is Composed  
of Hydrogen and Helium*

## Component 126 – Dark Nebulae

When the dust is so thick or the cloud is so big that light doesn't pass through the cloud it is called a **Dark Nebula**. These clouds are apparent when we look towards the center of our galaxy, or at other galaxies edge-on. Figure 391 shows the entire Milky Way Galaxy as seen from Earth. The dark lanes that are visible through the center of the pictures are dust and gas clouds between the Earth and the distant stars. There is so much dust and gas that we are not able to see the center of the Milky Way Galaxy.



The Sombrero Galaxy also shows a dense dust cloud around the edge of the galaxy as shown in Figure 392.

Light from stars as seen through a dust cloud often appears reddish. The bluer colors are scattered by the dust and gas in the nebula. This is very apparent by all of the red stars visible in the Coal Sack Dark nebula in Figure 393.

Some dense dust clouds that are quite cool have much more than atoms in their dust. Many clouds have been found that have high concentrations of molecules. These clouds are called Molecular Clouds. These clouds are among the largest dust clouds known.

The dust provides material to form the molecules as well as blocking interstellar radiation and preventing it from shattering the molecules. Many different molecules have been identified including water, ammonia, formaldehyde, methane, and benzene. They have also found amino acids.



## Component 127 – Emission Nebulae

As we learned in Spectroscopy (Component 32) light in specific frequencies is absorbed by various elements in a gas and dust cloud. Electrons are taken to a higher energy state, and eventually return to lower energy states. This re-emitted light is sent in different direction from the original light. When we see this re-emitted light from Earth, it makes the dust cloud glow. The most common element in the universe is hydrogen. The most common emission line associated with hydrogen in the visible part of the spectrum is the Balmer Series Hydrogen-Alpha line at a wavelength of 656.281 nm, which is **red**.

Gas and dust clouds in space that are emitting light are called **Emission Nebulae**. Figure 394 shows the Horsehead Nebula, a Dark Nebula resembling a knight on a chessboard blocking the light of an Emission Nebula in the constellation Orion. Figure 396 shows the **North America Nebula** in Cygnus. There are also other emission lines that appear in the brightest Emission Nebulae. Figure 395 of the **Orion Nebula** provide us with an example where yellows and greens are apparent.

Figure 328: The Horsehead Nebula



Photo by Ken Crawford

Figure 329: The Orion Nebula



Photo by Opo Terser

Figure 330: The North America Nebula



Photo by Philipp Salzgeber

## Component 128 – Reflection Nebulae

Another type of gas and dust cloud is a **Reflection Nebula**. Just as the sky on Earth is blue due to the Rayleigh Scattering of the bluer frequencies of light from the Sun, so too are some gas and dust clouds blue due to the scattering of starlight by the dust and gas in the gas cloud.

The **Pleiades** Open Cluster in Taurus is a great example of a Reflection Nebula (Figure 398, Figure 397). The light we see as blue is being scattered by the dust and gas in the neighborhood of the young stars in the open star cluster. Reflection Nebulae are more difficult to see in a telescope than are Emission Nebulae. Sometimes both nebulae can be seen in the same dust cloud as in the **Trifid Nebula** in Figure 397.

Figure 331: The Trifid Nebula



Photograph by  
Ljubinko Jovanovic

Figure 332: The Pleiades



## Component 129 – Forbidden Lines in Spectra

Scientists can study the spectra produced by different elements in a laboratory. Using this information those lines can be identified in the spectra of stars. But there are some lines that have been seen in the starlight that have not been produced in the laboratory. They are called **Forbidden Lines**. One color that was visible in some nebulae was **green**. For a time it was believed that this emission was due to an element that was not known on Earth.

Scientists now know that the characteristic green lines are the result of excited electrons, not from some new element, but from oxygen. Specifically this light is emitted by an electron transition in a doubly ionized oxygen atom. When this excited state occurs, it may be hours before the electron makes the transition. In space where matter densities are much lower than we can attain in our laboratories, the atom is left alone during this delay, and eventually the electron transitions and emits the green photons. In the laboratory there are too many particles and atoms, even in our best vacuum. There are trillions of particles having collisions every second. The atoms get bumped and the electrons move to different energy states. These emissions are allowed in the universe, but not on Earth, and are called Forbidden Lines.

Figure 333: The Orion Nebula



Photograph by ESA (the European Space Agency)

A good example of this emission can be seen in the Orion Nebula in Figure 399.

The Forbidden Lines are shown in Figure 400

Figure 334: Forbidden Lines

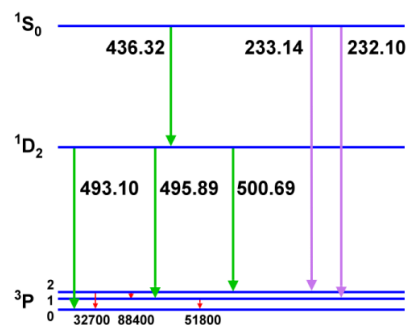


Diagram by Berklas



## Component 130 – Open Star Clusters

As dust clouds condense and fragment, stars are formed. From a fragment that may be about a light-year in diameter a star will form. In the overall dust clouds thousands of stars may form in a relatively short period of time. They become an **Open Star Cluster**. Open Clusters are a group of stars born together from the same gas and dust cloud. When we see them in space they have empty space between them.

Open clusters form where gas and dust is most plentiful. In spiral galaxies this is most often in the disk and spiral arms. When we look for Open Clusters in the night sky, most are found very close to the Milky Way.

Open Clusters have insufficient mass to be gravitationally bound together. Over time, the stars will drift apart. The Sun was most likely born as part of an Open Cluster, but today, 5 billion years later, there is no evidence of what stars were part of that cluster. The Pleiades, the **Hyades** and the **Coat Hanger** are examples of Open Star Clusters.

Figure 335: The Pleiades Cluster



Figure 336: CR 399 – The Coat Hanger

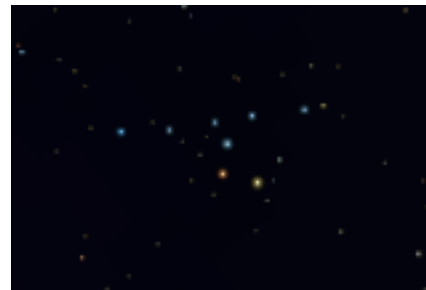
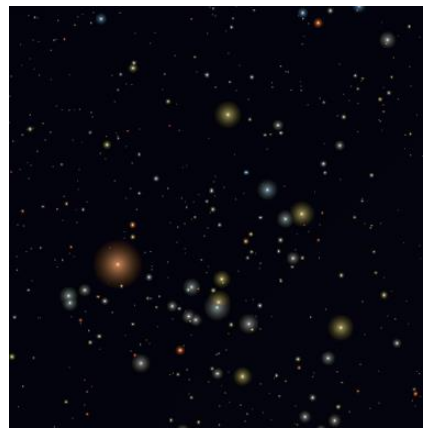


Photo by Roberto Mura

Figure 337: M11 – The Wild Duck Cluster



Figure 338: The Hyades Cluster



## Component 131 – Planetary Nebulae

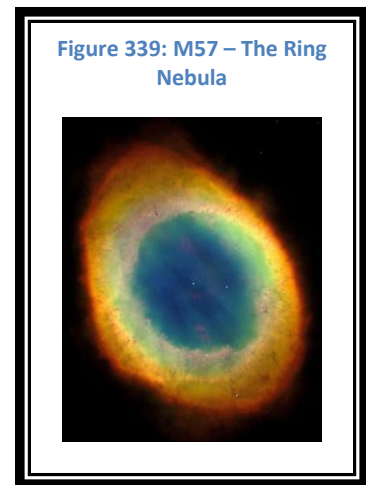
A Sun-like star has been around for billions of years. It has converted much hydrogen into helium, and much of that helium into carbon. As the amount of carbon in the core builds up, and the available helium diminishes, the pressure from fusion in the core also diminishes. Local temperatures in the shell of fusing helium begin to fluctuate. As this happens the fusion in the Triple-Alpha Process also begins to fluctuate. There are flashes of helium fusion occurring in the helium shell. These pulses cause fluctuations in the energy output of the star which causes the outer layers of the star's atmosphere to expand and contract.

As the core continues to collapse increasing the pressure, the fluctuations continue and grow in violence, and eventually the expansion is so strong that the outer layers of the atmosphere are blown away. This entire process may take from one to two million years. The materials are ejected at speeds exceeding 100 million miles per hour.

The core has now shrunk to a carbon/oxygen white dwarf. The last remnants of fusion continue. The core continues to collapse. This causes the temperature to continue to rise until the White Dwarf Stellar Remnant is so hot that it is radiating in the ultraviolet. This radiation expands outward and ionizes the material of the ejected atmosphere. The upper mass limit for a White Dwarf of 1.4 solar masses is called the Chandrasekhar limit. The White Dwarf Remnant will cool over time and eventually become a Black Dwarf.

This expanding shell of the ejected atmosphere continues to move outward until it is as large as our solar system. The radiation from the remnant causes the cloud to glow, forming the objects that we see from Earth, the **Planetary Nebulae**. The glow is caused by the same mechanism that makes Emission Nebulae glow. The nebula will expand and cool until it blends back into the local dust and gas cloud, after only a few tens of thousands of years. We have discovered over 1500 Planetary Nebulae in the Milky Way Galaxy. The **Ring Nebula**, the **Eskimo Nebula** and the Dumbbell Nebula are examples of these.

The exact shape of the Planetary Nebula varies widely. Events in the dying star as well as the environment around it result in some that appear to be fairly spherical as well as many that are quite exotic. The name, Planetary Nebula, has nothing to do with planets. They were named this because when first discovered by William Herschel, they resembled planets in his telescope.



During the final process of forming a Planetary Nebula, material from within the core is mixed with the star's atmosphere. As the temperatures continue to rise in the core, the carbon may combine with helium to form oxygen. It is also possible for heavier atoms, such as Neon and Magnesium, to form. When the atmosphere is ejected into space some of these atoms leave as well. It is believed that much of the carbon located in dust clouds throughout the galaxy originated in the form of Planetary Nebulae.

At this point, the core is about the diameter of the Earth and has lost 50% of its mass in the formation of the Planetary Nebula. Although some White Dwarf Stellar Remnants are seen near the center of their Planetary Nebulae, there are also many White Dwarf Remnants that have been found without the shell of glowing gas. The gas has faded into the background dust cloud, or was lost to another star.

*Most White Dwarf  
Stellar Remnants  
are made of Carbon*

Very low mass stars, like Red Dwarfs, when they reach the end of their life, will not be able to fuse helium into carbon. These stars will result in a White Dwarf Stellar Remnant that is composed of Helium rather than Carbon. Since Red Dwarf Stars may be on the Main Sequence for trillions of Years, there are not yet any Helium Core White Dwarf Stellar Remnants that formed this way. Another formation path is for a larger star in a multi-star system, while in its red giant stage, to strip off the outer layers of the atmosphere of a companion star, essentially stalling the natural life cycle. The reduction in mass could stop the fusion processes and leave the star as a Helium Core White Dwarf Stellar Remnant.

It is also possible for a star close to 8 solar masses, to produce small amounts of Neon from the existing Oxygen through the Alpha Process. This would result in a Neon Core White Dwarf Remnant. These are very rare, but some have been found.

Figure 340: The Helix Nebula



Figure 341: The Eskimo Nebula

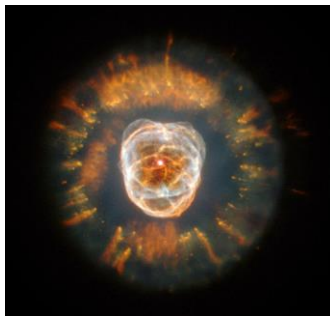


Figure 342: The Ant Nebula



## Component 132 – Core Collapse Supernovae

Whereas Red Dwarf Stars have a very quiet end, merely cooling as a White Dwarf Stellar Remnant without any fanfare or explosion, and sun-like stars end by ejecting their atmospheres into space, stars larger than 8 solar masses have rather dramatic endings; they explode as **Core Collapse Supernovae**. Figure 409 is an image of a Supernova Remnant, M1 – The Crab Nebula. Another example would be the Veil Nebula. These supernovae are called **Type II Supernovae**.

### The Core Collapse

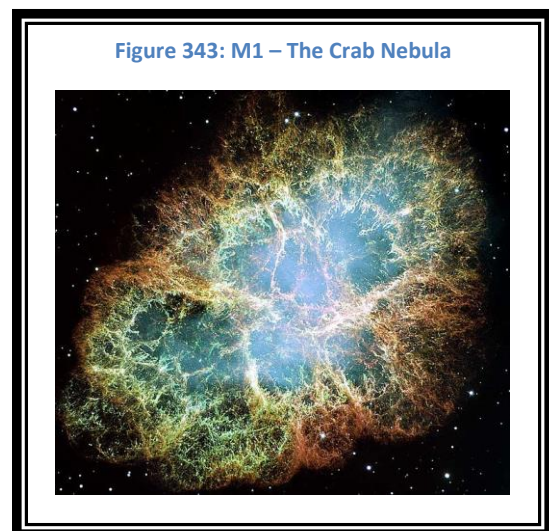
As the fusion processes decline in the core of the massive star, the outward pressure diminishes. Gravity collapses the core. The core may reach temperatures in excess of 10 billion K. At this high level of energy, photons are quite powerful. These high energy photons, when they collide with atomic nuclei, will break the nuclei apart into smaller atoms, protons, and neutrons. This is called **Photodisintegration**. Much energy is required to tear atoms apart. This removes energy from the core of the star. This drop in energy, causes the core to continue to collapse due to gravity. This part of the process only takes a few seconds.

Eventually the gravitational pressure is so strong that protons and electrons are crushed together. This results in neutrons and neutrinos. This part of the process also only takes a second or two. These neutrinos, like those created in the Sun, are able to radiate outward with no interaction with the surrounding material. The core of the star becomes a Neutron Star. It is a giant ball of neutrons crushed together. (See Component 133.)

If the mass is high enough after the Supernova, the core may continue to collapse into a **Black Hole**. (See Component 136.)

### The Rebound

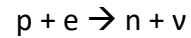
The collapse at this stage is so violent that the neutrons collapse further than they should. The core rebounds outward sending a powerful shockwave through the outer layers of the star, violently blowing off the outer layers of the star as a **Supernova Remnant**. For a few days after this collapse, the star will shine more brightly than its entire galaxy. It will then fade for several months until it blends into the background of its galaxy.



## Component 133 – Neutron Stars

For stars with initial masses between 8 and 15 solar masses the result of the **Supernova** explosion is likely a Neutron Star. Gravity is so strong that the collapsing core is able to overcome the Electron Degeneracy Pressure. The electrons and protons are fused together in the core creating **neutrons** and neutrinos. In this size star the stellar remnant is between 1.4 and 3 solar masses. The rest of the material was blown into space through stellar winds or into the supernova remnant. The 3 solar mass upper limit on Neutron Stars is called the Tolman-Oppenheimer-Volkoff limit.

### Equation 20: Neutron Star Formation



$\nu$  is the lower-case Greek letter nu and is the symbol for a neutrino

### Neutron Star Properties

**Neutron Stars** are very small and very dense. A typical neutron star would be approximately 12 miles in diameter. This means it would fit inside of Houston's I-610 inner highway loop. Because of their small size and heavy mass, the gravity near the surface of a neutron star is immense.

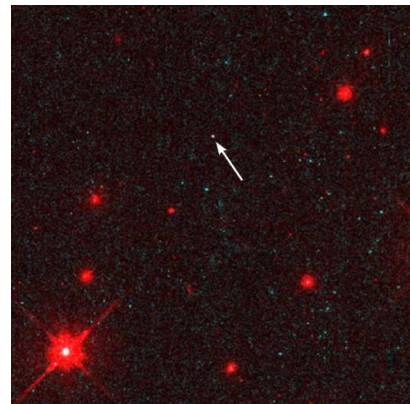
The angular momentum of the original star's core is largely preserved as the core contracts. As it contracts and the diameter shrinks, the rotation speed increases to maintain angular momentum. This is the same action you see in figure skating. If the skater is in a spin with arms outstretched, the rotational speed increases as the arms are brought inward. This means that a star that originally was spinning about once every 7 days would be rotating as a Neutron Star at a rate of one rotation per second.

Neutron Stars have very strong magnetic fields. They may be trillions of times stronger than the Earth's magnetic field. This is also a function of the collapse of the core. As the core shrinks, the magnetic field lines of the star are compressed.

The first visually observed Neutron Star is shown in Figure 410. It is RX J185635-3754 which is about 400 light-years away from Earth and formed approximately one million years ago.

There are approximately 2000 known Neutron Stars in the Milky Way Galaxy.

Figure 344: The First Visual Neutron Star



## Component 134 – Pulsars

Because of the rapid rotation and strong magnetic fields of Neutron Stars, the magnetic field lines are tightly wrapped around each other at the north and south magnetic poles. Figure 411 and Figure 412 are images taken of two **Pulsars**. In both cases a jet of high energy electromagnetic radiation can clearly be seen radiating from the center of the cloud. (See the diagram in Figure 413.)

If the **magnetic** axis is not the same as the rotation axis, due to the Neutron Star's **rotation**, the direction that this jet is pointing orbits around the pole. If Earth is somewhere along the circle that the magnetic pole faces in the sky, then the Earth will see a flash of the electromagnetic radiation every time the Neutron Star rotates. This is the "pulse" of the Pulsar. This provides a very accurate rotational period. Most pulsars have a frequency of between 3 and 30 pulses per second.

There are over 1,500 known Pulsars that have been identified in the Milky Way Galaxy. It is believed that the jets weaken over time, and after a few tens of millions of years the pulse may no longer be detectable.

In the 1980s a new type of Pulsar was discovered. They rotate extremely rapidly, with a period of only milliseconds. These are called **Millisecond Pulsars** and approximately 250 are known in our galaxy. The currently accepted theory for how this could be possible is that the Neutron Star is part of a Binary Star System. Its companion star has been sharing material with the Neutron Star. As this material spirals into the Neutron Star, its angular momentum is added to the Neutron Star's angular momentum, and the Neutron Star spins faster.

Figure 345: Vela Pulsar

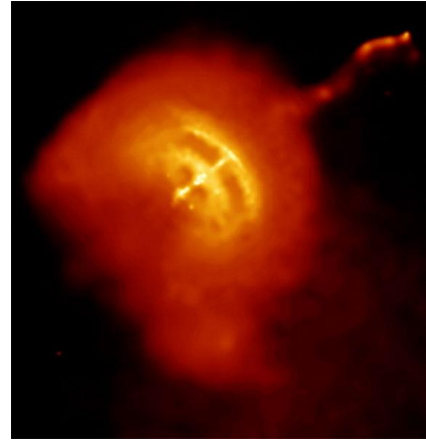


Figure 346: Crab Nebula Pulsar

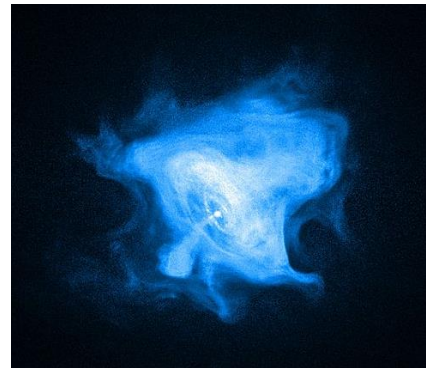


Figure 347: Pulsar Components

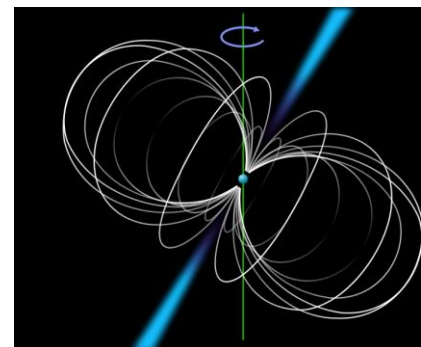


Diagram by MySid

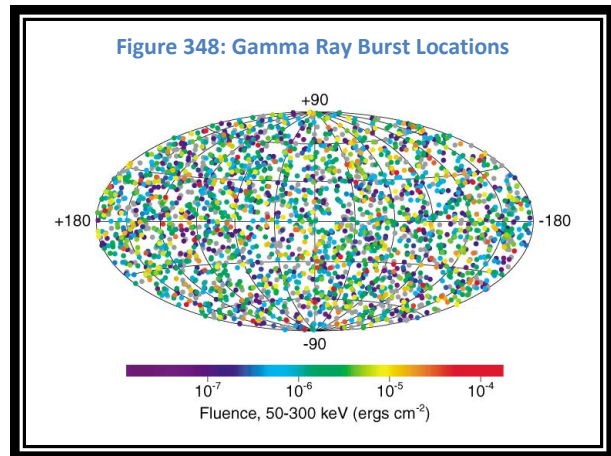
## Component 135 – Gamma Ray Bursts

A **Gamma Ray Burst** is one of the most energetic bursts of electromagnetic radiation ever detected. These bursts can be as short as 10 milliseconds, or they can last as long as several hours. The sources for these bursts appear to be billions of light-years from Earth. This means that they are quite distant, but also must be very strong.

### History of Gamma Ray Bursts

Gamma Ray Bursts were first detected in 1967 by Vela Satellites. A survey of the entire sky was done by the Compton Gamma Ray Observatory using its very sensitive Burst and Transient Source Explorer instrument. The results of the survey can be seen in Figure 414. The data from over 2700 bursts show that there is no increase in activity where the Milky Way Galaxy is in the picture, so the sources

must be outside of the galaxy. In 1997 the first measurement of the distance to a Gamma Ray Burst was done. By combining information from the burst with information from the afterglow in several different frequencies, it was determined that the burst originated approximately 7 billion light-years away from Earth.



### Classifications of Gamma Ray Bursts

**Short Gamma Ray Bursts** are those of durations shorter than two seconds. 30% of all recorded bursts are of this type. These events do not seem to be associated with massive stars or Supernovae. The average duration of a Short Gamma Ray Burst is 0.2 seconds. This implies that the source must be very small, about four times the diameter of the Earth. **Long Gamma Ray Bursts** have durations between 2 and 10,000 seconds. This represents 70% of all recorded bursts. **Ultra-Long Gamma Ray Bursts** have durations greater than 10,000 seconds. Very few of this type have been detected.

### Sources of Gamma Ray Bursts

Short Gamma Ray Bursts appear to originate in the merger of two Neutron Stars or a Neutron Star with a Black Hole. Long Gamma Ray Bursts appear to originate in galaxies with much active star formation. It also appears that many are associated with Type II Supernovae. Ultra-Long Gamma Ray Bursts are thought to originate in the death of a massive blue dwarf star

## Component 136 – Black Holes

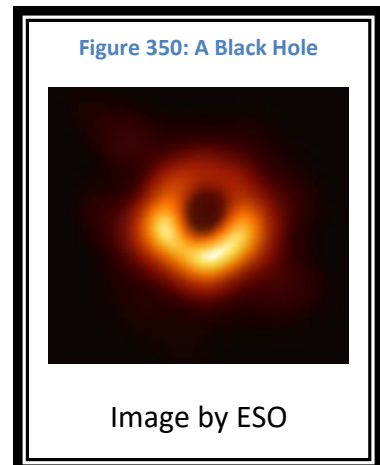
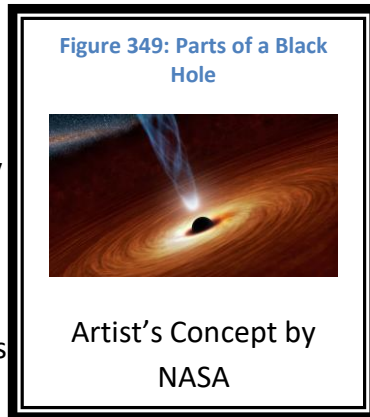
Massive stars become Neutron Stars. Really massive stars become Black Holes. For stars more massive than 15 solar masses, whose stellar remnant is greater than 3 solar masses, the collapse does not stop at the Neutron Star. The gravity is so strong that it overcomes the **Neutron Degeneracy Pressure**. The core collapses beyond where the escape velocity exceeds the speed of light. Since nothing can move faster than the speed of light, nothing can escape within that distance. What we would see in space is nothing! The only things we can measure of a Black Hole is **Mass, Spin** (Angular Velocity), and **Charge**.

### Parts of a Black Hole

Scientists are not sure what happens to the matter in a Black Hole. Theory says that it will continue to collapse until it is a single point. This is called the **Singularity**. The distance to where light can't escape the gravity is called the Schwarzschild Radius. A sphere at that distance from the Black Hole is called the **Event Horizon** and is the black sphere in Figure 416. There are charged particles radiating outward as **Jets** from the magnetic poles of the spinning blackhole. One of the jets is in Figure 415 as the narrow white area. The remaining part of a Black Hole is the **Accretion Disk**, shown in brown in Figure 415.

### Calculating the Event Horizon

The **Schwarzschild Radius** is easily calculated if you know the mass of the Black Hole. Equation 21 shows the formula to calculate the size of the **Event Horizon**.



### *Parts of a Black Hole:*

- *Singularity*
- *Event Horizon*
- *Jets*
- *Accretion Disk*

*We can only Measure  
Mass, Spin, & Charge*

### Equation 21: The Event Horizon

$$R_s = 3 * M_{\text{solar}}$$

$R_s$  is the Schwarzschild Radius in km.  
M is the Mass in Solar Masses



## Component 137 – Einstein and Relativity

A little over 100 years ago Albert Einstein developed the Theory of Relativity. These two theories, Special Relativity and General Relativity, both play a central role in our understanding of how space and time behave in the vicinity of a Black Hole.

### Special Theory of Relativity

In 1905 Einstein proposed this theory. Light, no matter how fast the speed of the source or the receptor of that light, has a speed limit. This is the familiar 186,000 miles per second or 300,000 kilometers per second. This concept is very different from what we know and experience in traditional physics, where velocities add and subtract to give the apparent velocity.

When we talk about speeds that are very fast, speeds that are a significant fraction of the speed of light, then the old rules do not apply. The new theory presents us with a few new rules:

- The **speed of light**,  $c$ , is a speed limit. Nothing can move faster than the speed of light, and it is constant.
- All observers will see the speed of light as exactly the same speed no matter how fast they are moving, and no matter how fast the source of the light is moving.
- There is no absolute inertial frame of reference in the universe. Everything in the universe is moving relative to everything else. There is no preferred location in the universe.
- Space and Time are linked together. You can't consider one without the other. It is called **Spacetime**.

Equation 22: Time and Relativity

$$T = \frac{T_0}{\sqrt{1 - \left(\frac{v^2}{c^2}\right)}}$$

$T_0$  = Time at rest

$T$  = Time

$v$  = Velocity

$c$  = Speed of Light

Equation 23: Mass and Relativity

$$M = \frac{M_0}{\sqrt{1 - \left(\frac{v^2}{c^2}\right)}}$$

$M_0$  = Time at rest

$M$  = Time

$v$  = Velocity

$c$  = Speed of Light

Equation 24: Velocity and Relativity

$$V_o = \frac{V_s}{\sqrt{\left(\frac{1 + \frac{v}{c}}{1 - \frac{v}{c}}\right)}}$$

$V_o$  = Velocity Observed

$V_s$  = Velocity of the Source

$v$  = Velocity of the Source relative to the Velocity of the Observer

$c$  = Speed of Light

Note:  $v$  is positive if it is approaching.

- An object moving close to the speed of light will shorten in the dimension in which it is travelling. This is called the Lorentz Contraction.
- Time on an object moving close to the speed of light slows down. This is known as Time Dilation.
- The mass of an object moving close to the speed of light increases.
- Energy and mass are related using the famous equation:  $E = m * c^2$ .

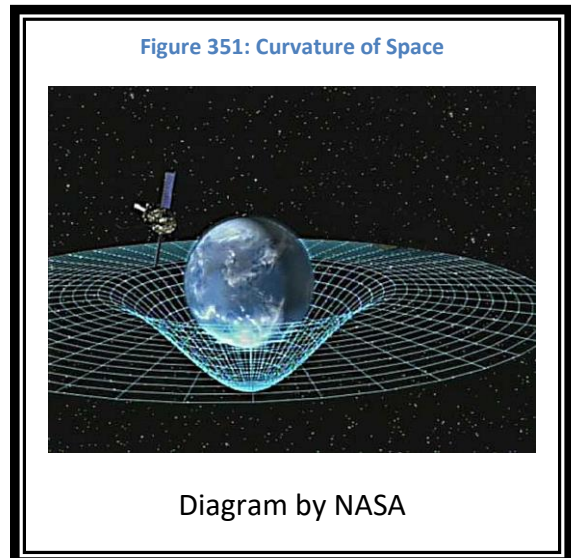
### **General Theory of Relativity**

In 1915 Einstein was able to work gravity into relativity. Special Relativity deals with velocities but not **acceleration**. Einstein realized that gravity was no different than other forms of acceleration acting on an object. This is called the Equivalence Principle.

Einstein was famous for his thought experiments, and one such experiment played a major role in the development of the General Theory of Relativity. If you take two people and place them in a sealed elevator with no windows, and place one of them on Earth and the other behind a rocket ship accelerating with the same force as the gravity, neither one would be able to tell you which person was in which situation.

This enhanced theory presents us with some additional new rules:

- Objects with mass warp spacetime in their vicinity. The more mass, the more curvature.
- Objects near the mass follow the lines of the curvature of spacetime (like contour lines on a topographical map).



This explains how satellites orbit the Earth, as well as how the Earth orbits the Sun. It also explains how light curves around the Sun during a total solar eclipse. At that time, we are able to see stars that are actually behind the Sun.

### **Black Holes**

Now imagine what happens in the vicinity of a Black Hole. Space becomes very tightly curved and actually curves in upon itself. If you are within this curvature, there is no means to escape. All objects have an escape velocity. That velocity decreases as the distance increases. In the

case of a Black Hole, the Event Horizon is that point where the escape velocity is equal to the speed of light. Since nothing can travel faster than that, nothing, including light, can escape.

The gravitational force increases significantly as an object approaches a Black Hole's Event Horizon. Eventually, the force at the front end of the object is so much greater than the gravitational force on the back end of the object, the object is pulled apart. As the pieces get closer to the Black Hole, the effect continues and stronger forces pull the object into smaller pieces until it is loose atoms. This has been commonly referred to as Spaghettification. As this occurs, the materials heat up. As they approach the Event Horizon they heat so much that they are emitting X-Rays. We can see these emissions, until the matter falls into the Event Horizon, and then we see nothing.

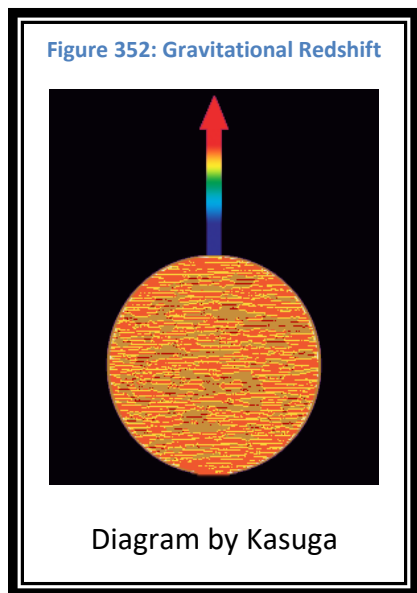
In addition to these physical effects, but separate, is a change to the electromagnetic radiation that is being emitted. Light escaping from the vicinity of a massive object is red-shifted. This is known as **Gravitational Redshift**. In an effort to escape the gravitational pull, the photons must exert some energy. This energy is lost. Since they do not change their velocity, they reduce their frequency since energy is proportional to frequency. ( $E=hf$ )

From our perspective on Earth, time on the object would slow down. To anyone on board the object, time would appear to continue normally.

### **Evidence that Space is Curved**

Astronomers have found evidence that space really is curved. Figure 419 is an image that shows arcs of light that are from distant galaxies that are behind the foreground galaxies. This light is being bent by the gravitational fields of the closer galaxies and is called **Gravitational Lensing**. Another example is shown by Figure 421, the **Einstein Cross**. This is an image of a foreground galaxy in the center with four images of the same quasar around the edge. These images have the same spectral signature, so must be the same object.

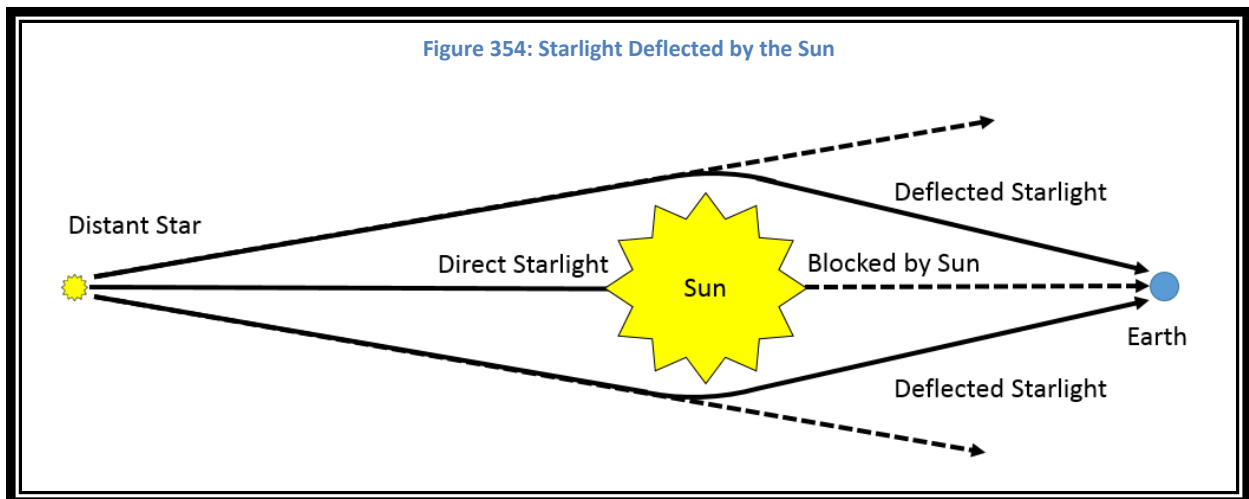
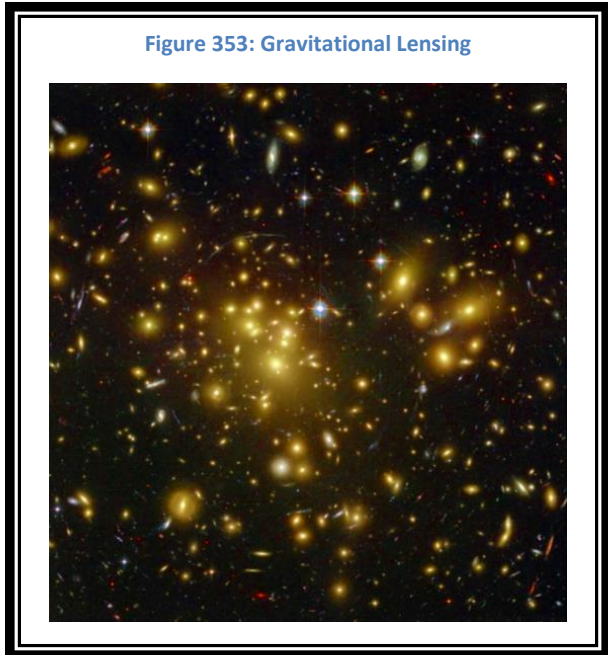
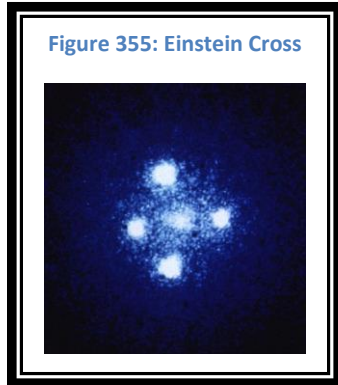
Figure 420 shows how light from a distant star can be deflected by the gravitational field of the Sun.



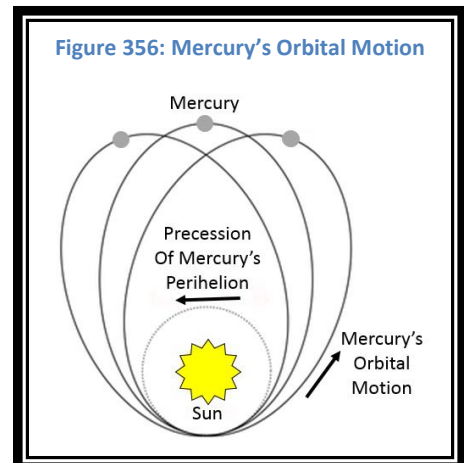
*There is a Gravitational Redshift due to the mass of nearby objects*

During a **total solar eclipse** it is possible to see instances of stars that are actually behind the Sun. The maximum deflection is 1.75 arc-seconds. This is a tiny amount, but it is detectable using instruments near Earth.

This was first tested by Sir Arthur Eddington in 1919 on an expedition to the Island of Principe off the west coast of Africa. He was successful in imaging stars from behind the Sun as Einstein's theories predicted.



Relativity also affects the orbits of planets, and **Mercury**, as close is it is to the Sun, shows the largest effect. Relativity predicts that Mercury's orbit is not truly an ellipse, but actually the orbit itself rotates around the Sun. The shift is only 43 arc-seconds per century, but is measurable. Relativity is required to predict the movements of Mercury.



## Component 138 – Binary Stars

Although the Sun is not part of a multi-star system, it appears that many stars are. Only 15% of the stars in the Milky Way are single stars. When you have stars in a binary star system, the life cycle for one star is affected by the other star. There are three types of **Binary Star Systems**: **Detached Binaries** (top in Figure 423), **Semi-Detached Binaries** (center), and **Contact Binaries** (bottom).

### Detached Binary Stars

Detached Binaries are two stars that are gravitationally bound to each other. They orbit each other, but both stars are within their **Roche Lobes**.

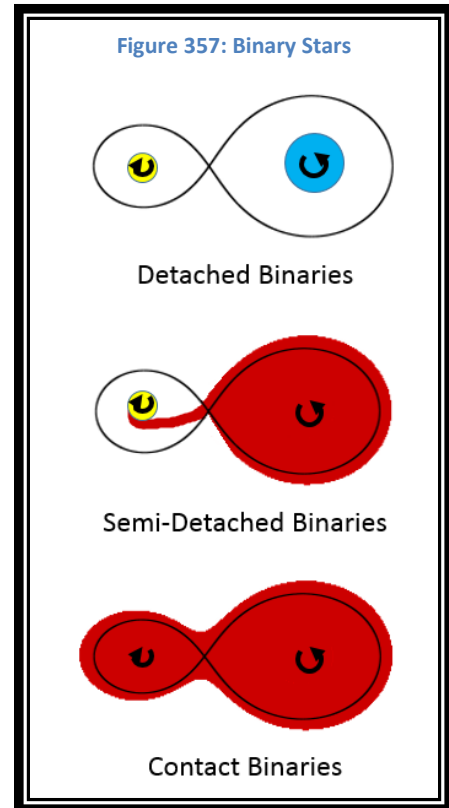
### Semi-Detached Binary Stars

When one of the stars has evolved to the Red Giant Stage, it may exceed its Roche Lobe. As matter outside the Roche Lobe rotates into the companion's Roche Lobe it can be captured and falls onto the companion's accretion disk.

### Contact Binary Stars

The third case is when both stars have evolved into the Red Giant stage. In this situation both stars are exceeding their Roche Lobes. Both stars are sharing matter with the other star.

When this occurs the increase or reduction in matter can change the life cycle for the stars. There are some specific situations when this causes some interesting things to happen. These are discussed in Component 139 and Component 140



*There are 3 types of Binary Star Systems:*

- *Detached Binary*
- *Semi-Detached Binary*
- *Contact Binary*

## Component 139 – Novae

If a **White Dwarf** Stellar Remnant is part of a Semi-Detached Binary System, and its companion becomes a Red Giant Star that has expanded past its Roche Limit, that Red Giant Star will contribute material to an Accretion Disk. A Nova will experience a sharp increase in brightness and then it will dim gradually. It is a thousand times dimmer than a Supernova.

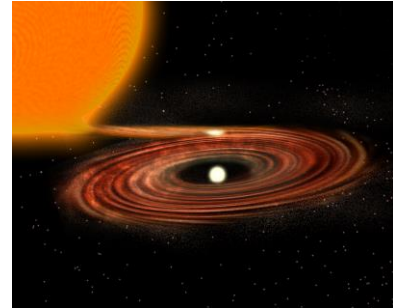
Novae are caused by the material from the companion star falling onto the surface of the White Dwarf Stellar Remnant. This hydrogen suddenly fuses and results in the outburst.

Novae can happen repeatedly on the same White Dwarf.

There are four classifications of **Novae**:

- **NA: Fast novae:** a rapid brightness increase, followed by a decline of 3 magnitudes in the next 100 days.
- **NB: Slow novae:** a decline of 3 magnitudes in 150 days or more
- **NC: Very Slow novae:** staying at maximum brightness for a decade or more and then fading very slowly.
- **NR: Recurrent novae:** novae with multiple brightness outbursts separated by 10–80

Figure 358: Accretion Disk

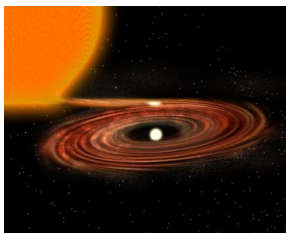


Drawing by NOAA

*Novae are fainter than Supernovae*

*Novae can recur*

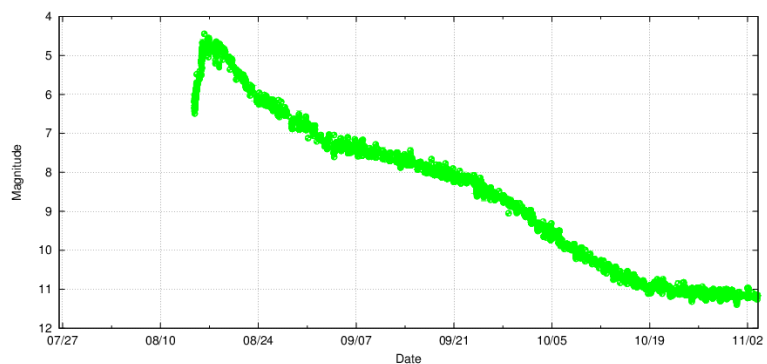
Figure 360: Accretion Disk



Drawing by NOAA

years.

Figure 359: Nova Delphinus 2013



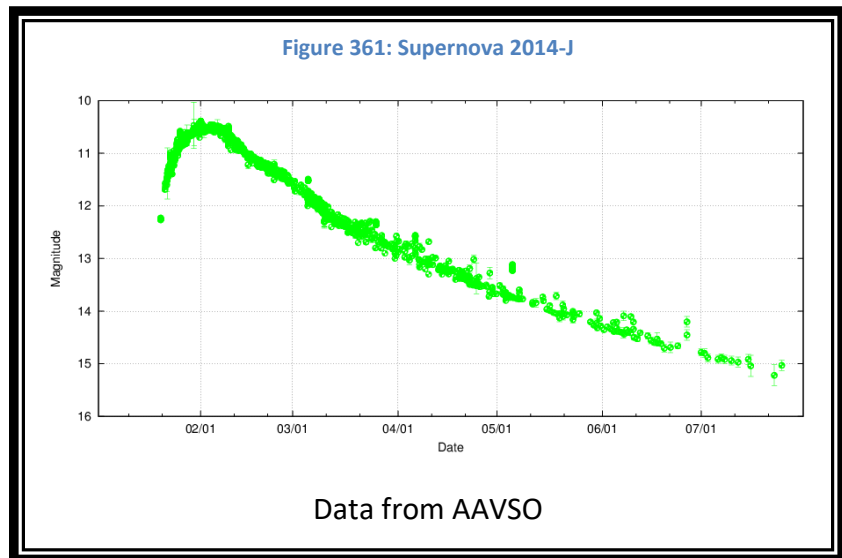
Data from AAVSO

## Component 140 – Carbon Detonation Supernovae

But what happened if the infalling matter pushes the mass of the **White Dwarf** Stellar Remnant beyond 1.4 solar masses, the **Chandrasekhar Limit**? When this happens there is a massive detonation of the carbon of the White Dwarf Stellar Remnant. All of the carbon begins to fuse at once, so there is a massive Supernova explosion. This is a Type I Supernova and is called a **Carbon Detonation Supernova**. This is different from the Core Collapse Supernova of large mass stars, which is a Type II Supernova.

An alternative mechanism to cause the same outcome could be the merging of two White Dwarf Stellar Remnants.

These Supernovae show very little hydrogen in their spectra because the amount of hydrogen available is a much smaller proportion than in Type II Supernovae. The remnant of a Type I Supernova explosion is nothing. It is believed that these stars blow themselves apart. Figure 427 is a chart from the American Associate of Variable Star Observers for Supernovae 2014-J. Much of this data was supplied by the Insperity Observatory in Humble, TX.



Type Ia Supernovae are standard candles used to measure the distance to galaxies. The **Absolute Magnitude** for a Type Ia Supernova is -19.3 due to the mass of the remnant being the Chandrasekhar Limit of 1.4 Solar Masses.

*Type Ia Supernovae are  
Standard Candles for  
measuring distance*

## Component 141 – Gravitational Waves

Just as Electromagnetic Radiation moves outward through space in waves with photons as the quantum particle used to carry the electromagnetic force, it is reasonable to assume that the gravitational force radiates outward through space in **Gravitational Waves** with gravitons as the quantum particle used to carry the gravitational force. Expanding on Einstein's General Theory of Relativity in 1934, Blokhintsev and Gal'perin developed a theory that predicts that gravitons should exist.

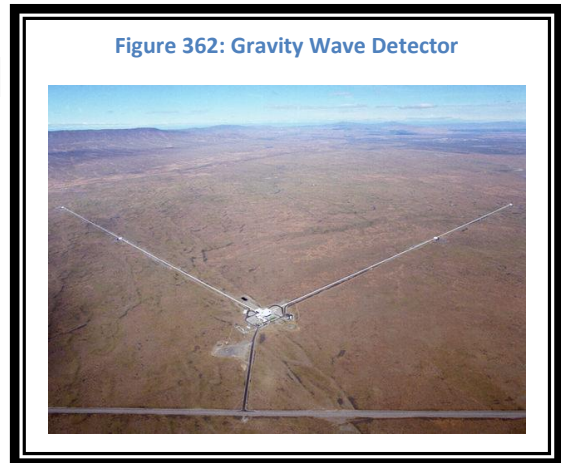
Although it is not practical for us to detect individual gravitons it is possible to detect gravitational waves. **LIGO** and **VIRGO** experiments have detected these waves and could yield information on specific characteristics of gravitons. For more information on these experiments go to the websites indicated:

For LIGO: <http://www.ligo.org/>

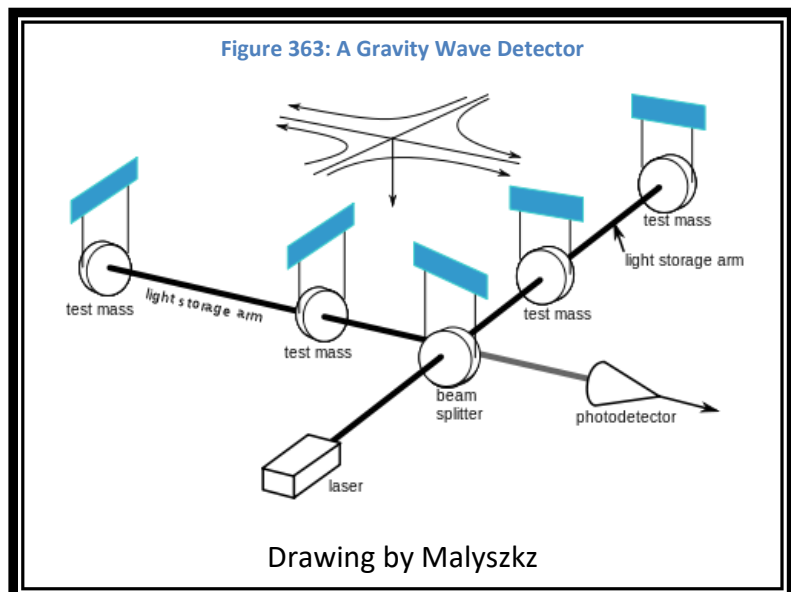
For VIRGO: <http://www.virgo-gw.eu/>

Whereas Electromagnetic Radiation in the form of the Cosmic Microwave Background Radiation can take us back towards the big bang to the point where the universe was transparent to photons at an age of 378,000 years, Gravitational Radiation in the form of Gravitational Waves can take us back to the point where the universe became transparent to gravity at  $10^{-43}$  seconds after the Big Bang.

It is believed that these waves would originate from two massive orbiting objects and also from supernovae explosions. They were first observed in 2015.



*Supernovae and Binary Systems Likely Radiate Gravity Waves*

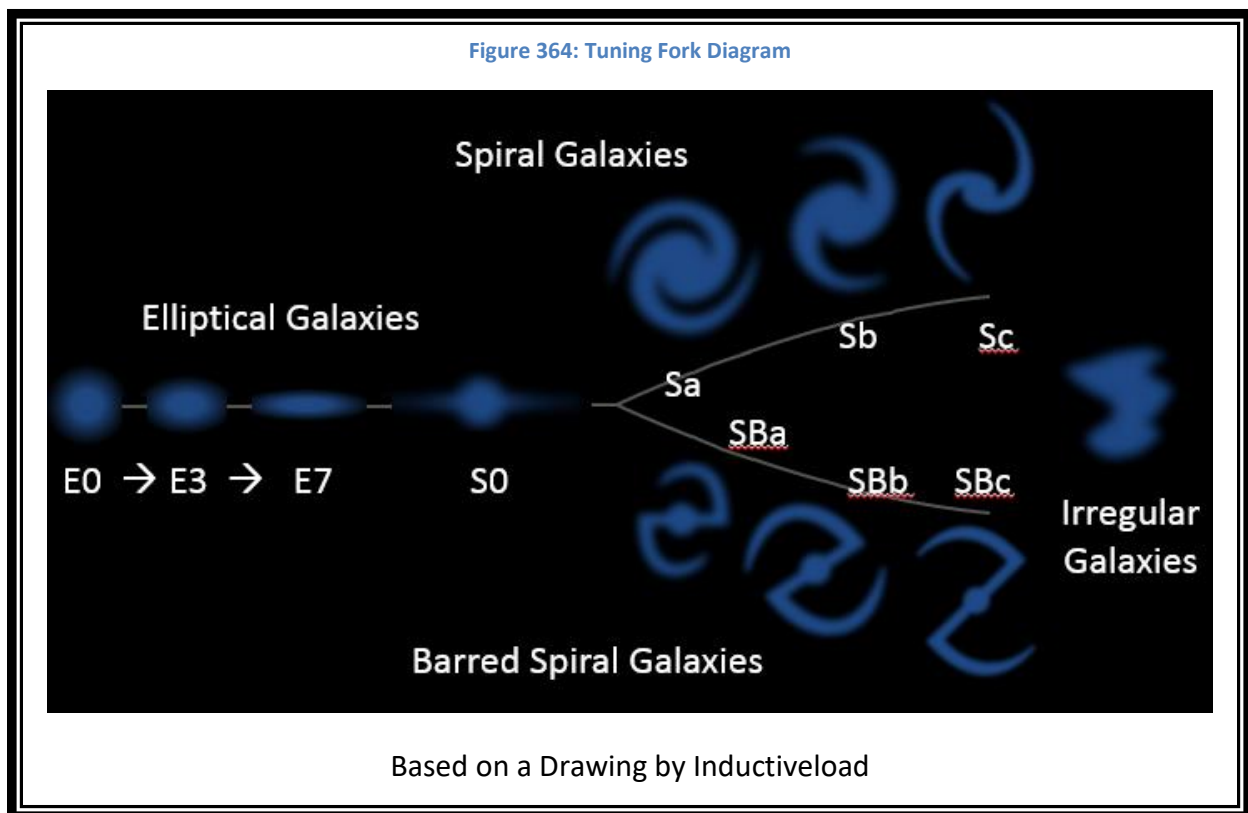




## Component 142 – Classification of Galaxies

When we peer out into space we see many stars and other objects that are fairly close by. But we also see large collections of stars and objects that are quite far away and seem to be their own islands. When you have millions, billions, or even trillions of stars that are all gravitationally bound to each other, you have a galaxy. When we survey our skies, we see that there are billions of these **galaxies** in all directions.

Initially, astronomers were not aware that there were structures beyond our local galaxy. Edwin Hubble, in 1924 was the first astronomer to classify galaxies into classes. His classes were: Spiral Galaxies, Barred-Spiral Galaxies, Elliptical Galaxies, and Irregular Galaxies.



These classifications are often shown in a **Tuning Fork Diagram**. E0 through E7 are Elliptical Galaxies. E0 is round and E7 is cigar shaped. S0 is a galaxy with a disk but no evidence of spiral arms. The S galaxies are the Spiral Galaxies, and the SB galaxies are the Barred-Spiral Galaxies. The a, b, and c designations show how tightly the spiral arms are wound. An “a” indicates those that are fairly tightly wound. A “c” indicates those that are loosely wound.

## Component 143 – Spiral and Barred Spiral Galaxies

Some galaxies are large rotating disks of stars. There are two types of **Spiral Galaxies**, those with bars (Type SB) and those without bars (Type S). These types are then broken up into sub-categories based on the size of the central bulge (large to small: Sa, Sb, and Sc; and SBa, SBb, and SBC). Spiral type galaxies often have **Billions** of stars, although some are smaller and may have only millions of stars.

These are the parts of Spiral and **Barred Spiral Galaxies**:

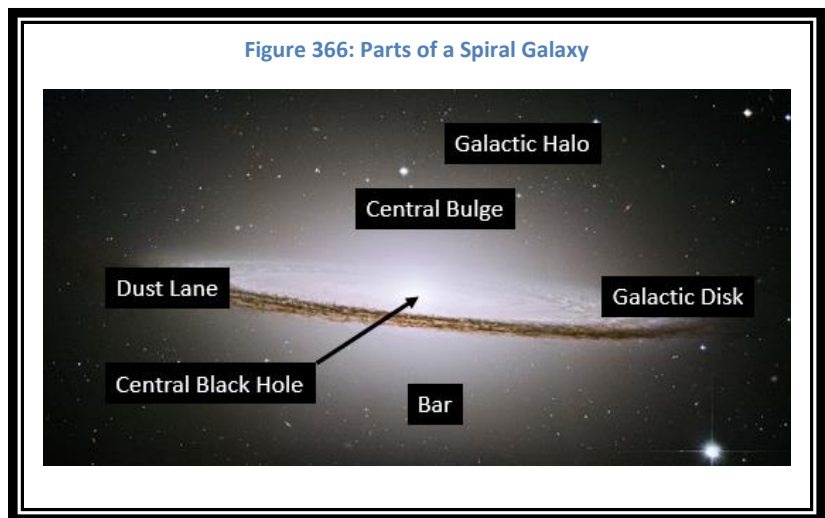
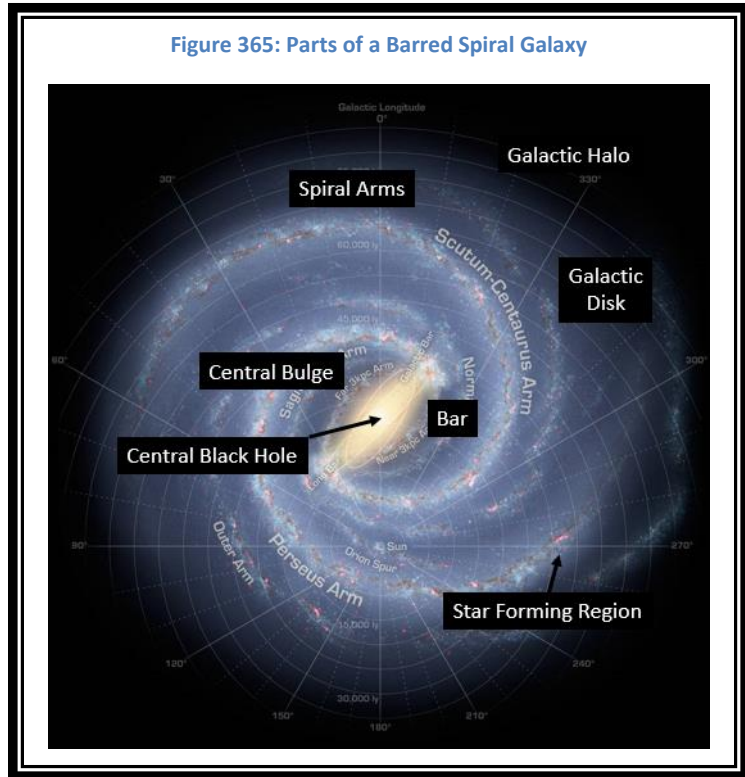
- The **Central Black Hole**
- The Central Bulge
- The **Bar** (found in Barred Spirals only)
- The **Galactic Disk**
- The **Spiral Arms**
- **Dust Lanes**
- The **Galactic Halo**

### The Central Bulge

The Central Bulge is composed of older stars in random orbits. There is very little dust and gas.

A larger Bulge means:

- A larger Black Hole
- More tightly wound Spiral Arms
- More Spiral Arms
- Better defined Spiral Arms



### **The Disk**

The Disk has much dust and gas. It is the site of much star formation and there are many Open Star Clusters. There are many young stars. This is also where the Spiral Arms are found. The class of galaxy that has a disk but no detectable spiral arms is class S0.

### **The Spiral Arms**

Spiral arms are tight and orderly as in subclass a, or they can be loose and sloppy as in subclass c. These are represented by images in Figure 434 through Figure 439.

### **The Halo**

The Halo is roughly spherical and is the diameter of the galactic disk. It has old stars with little dust and gas and is where the Globular Clusters are found.

Figure 367: Type S0 Galaxy

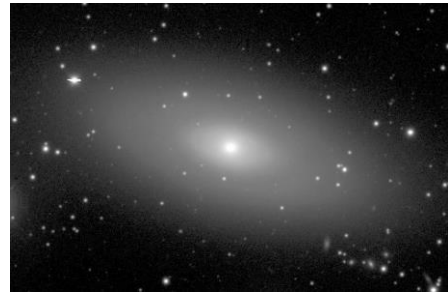


Figure 368: Type Sa Spiral Galaxy



Figure 369: Type Sba Galaxy



Figure 370: Type Sb Spiral Galaxy



Figure 371: Type SBb Galaxy



Figure 372: Type Sc Spiral Galaxy



Figure 373: Type SBc Galaxy



## Component 144 – Elliptical Galaxies

**Elliptical Galaxies** have no obvious structure but are shaped as ellipsoids. The stars are in random orbits around the center of mass. They contain little dust and gas, so there is little star formation.

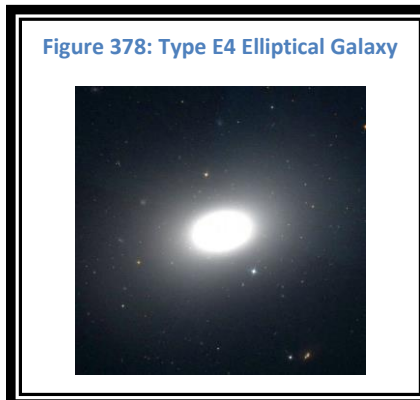
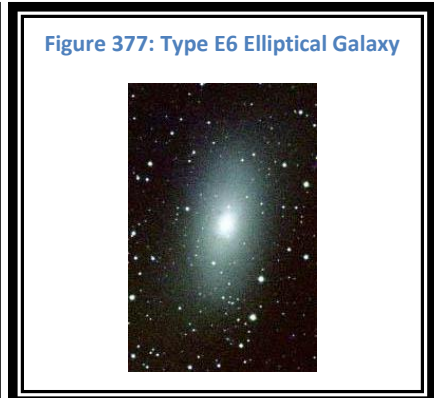
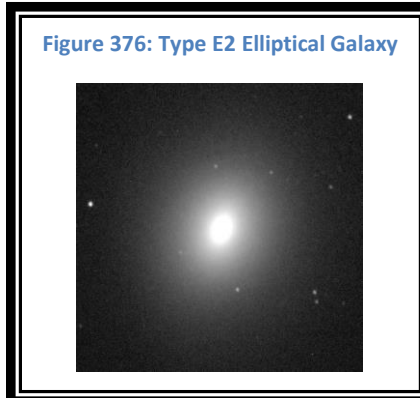
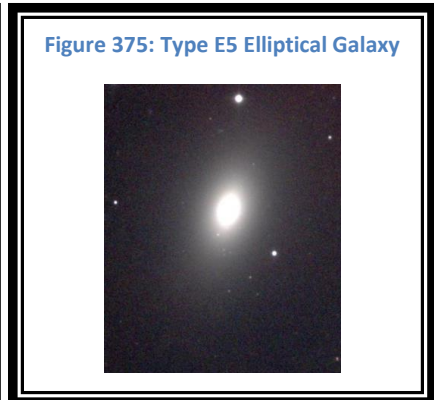
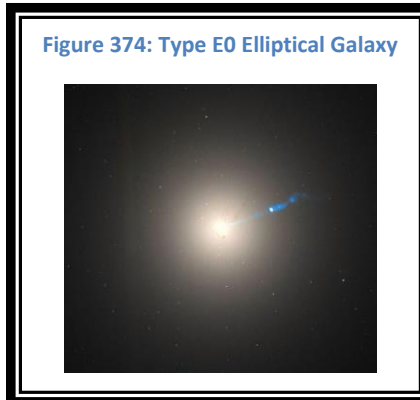
### Galaxy Sizes

Elliptical Galaxies range in size from dwarf galaxies of millions of stars to giant galaxies of **trillions** of stars, the largest galaxies known. They can have diameters as small as 350 light-years, or as large as 325,000 light-years.

### Types of Elliptical Galaxies

Elliptical Galaxies are sub-categorized based on how spherical they are. Those that are almost perfect spheres are type E0. Those that are very elongated, and more cigar shaped, are type E7.

A selection of Elliptical Galaxies are shown in the images in Figure 440 through Figure 445



## Component 145 – Irregular Galaxies

**Irregular Galaxies** have no specific shape and no obvious structure. They are large collections of stars that are gravitationally bound to each other. They typically number in the millions of stars. The **Milky Way Galaxy** has two satellite galaxies that are irregular galaxies: The Large and Small Magellanic Clouds.

Dwarf Galaxies tend to have significant amounts of dust and gas, and there is active star formation.

### The Large Magellanic Cloud

The Large Magellanic Cloud is the fourth largest galaxy in the local group (after **Andromeda**, the Milky Way, and the Triangulum Galaxy) with a diameter of 14,000 light-years. There are some who have classified it as a new type of Barred Spiral Galaxy called a Disrupted Barred Spiral. There is strong evidence that it has a significant bar of stars running through its center.

It is also the third closest galaxy to the Milky Way. It is 163,000 light-years away. Unfortunately it is in the southern skies so is not visible from the United States.

### The Small Magellanic Cloud

The Small Magellanic Cloud is a dwarf galaxy located in the constellation Tucana. It is 7,000 light-years in diameter and is 200,000 light-years away. Unfortunately it is in the southern skies so is not visible from the United States.

Figure 380: The Large Magellanic Cloud



Figure 381: The Small Magellanic Cloud



## Component 146 – Galactic Comparisons

Table 41 compares features found in the different types of galaxies.

**Table 41: Galaxy Comparison by Type**

	Spiral and Barred Spiral	Elliptical	Irregular
Size	Dwarf to Large	Dwarf to Giant	Dwarf
Shape	Disk with central bulge	Ellipsoidal	None
Structure	Spiral arms and halo	None	None
Stars	Young in disk, old in bulge and halo	Old	Young
Gas & Dust	In disk, but not in bulge and halo	None	Yes
Star Motion	Circular in disk, random in bulge and halo	Random	Random
Star Formation	In disk, but not in bulge and halo	None	Yes

Table 42 outlines the types of galaxies found in the local group.

Dwarf Spherical Galaxies are very faint galaxies and this classification is only used in the local group. They are members of the elliptical galaxies but are fairly spherical.

**Table 42: Galaxy Types in the Local Group**

Type	Quantity
Spiral and Barred Spiral	3 Andromeda Galaxy (M31) The Milky Way Galaxy Triangulum Galaxy (M33)
Giant Elliptical	0
Elliptical	1 M32 in Andromeda
Dwarf Elliptical	5
Dwarf Spherical	36
Irregular	12
Unclassified	10

*Galaxy Types are:*

- *Spiral Galaxies*
- *Barred Spiral Galaxies*
- *Elliptical Galaxies*
- *Irregular Galaxies*

## Component 147 – Galaxy Clusters

### The Local Group

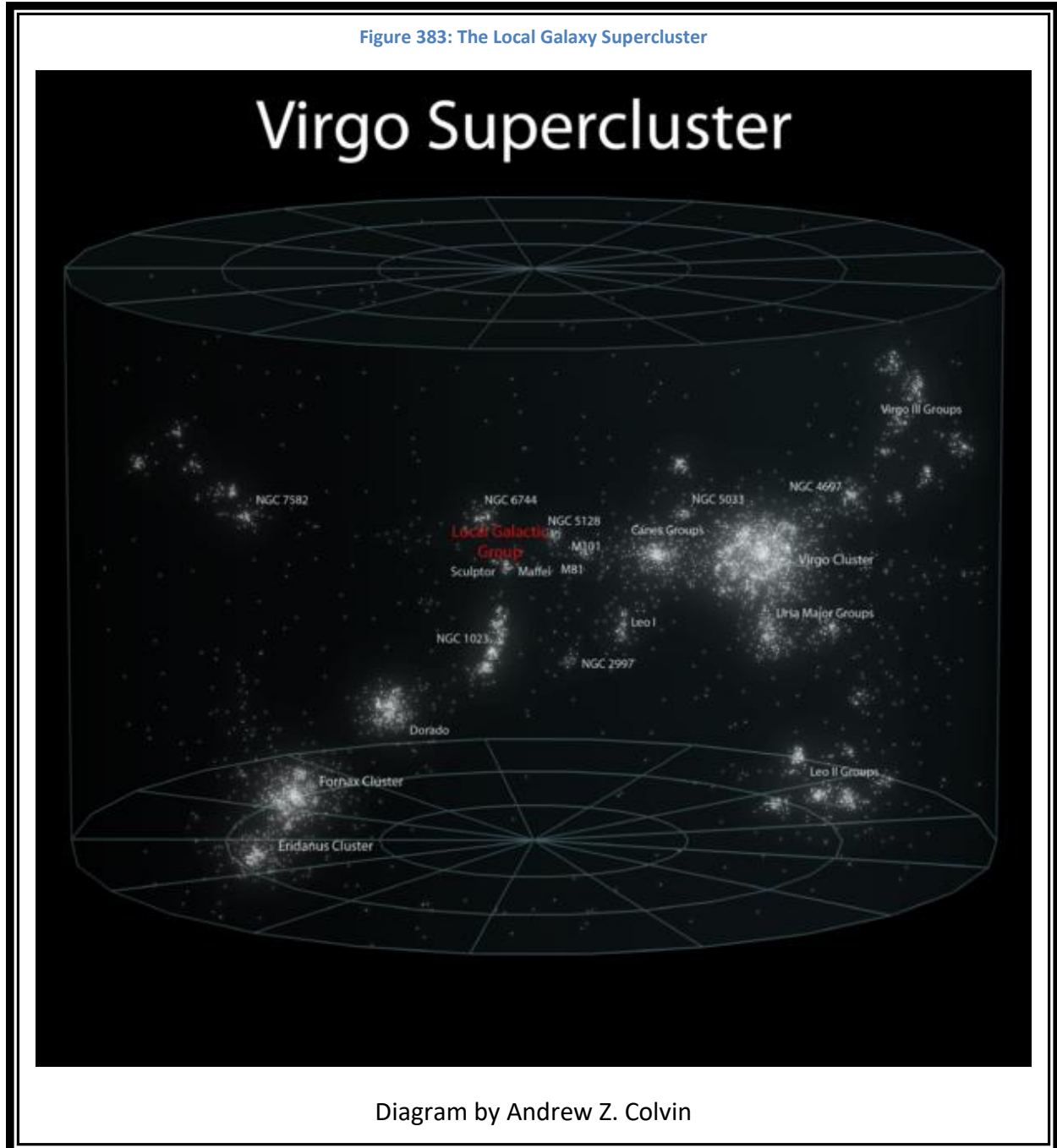


The **Local Group** of Galaxies consists of the Milky Way Galaxy and its satellite galaxies, and also the Andromeda Galaxy and its satellite galaxies. This is a total of 67 known galaxies.

The diameter of the Local Group is over 3.3 million light-years.

## The Virgo Supercluster

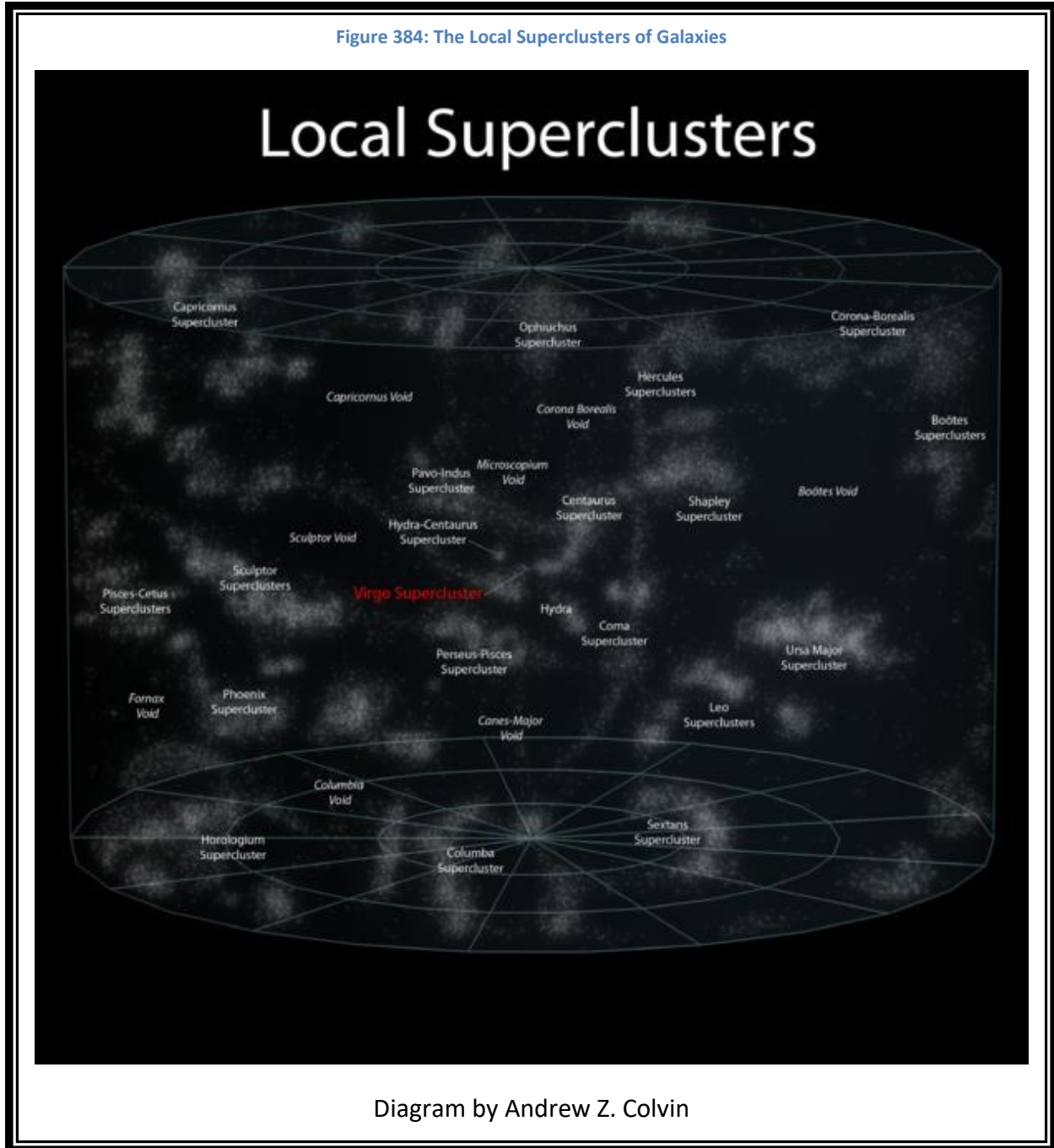
Our Galaxy **Cluster** is part of a larger structure, a **Local Supercluster**, called the Virgo Supercluster.





**Extended Structure**

When you look beyond our local Supercluster you find more superclusters.



## Component 148 – Galaxy Recession and Red Shift

Most galaxies in the universe are receding from us. Those that are local are not, and they exhibit the motions associated with galaxies gravitationally bound in a cluster. This was first noted by Vesto Slipher who was working with Percival Lowell. This was determined by the red shift of lines in the spectra for those galaxies. The **Galaxy Recession** speeds were charted on a graph by **Edwin Hubble** in the 1920s. What he observed was that the recessional velocity of distant galaxies is directly related to the distance to that galaxy. This is what we know as Hubble's Law.

These galaxies are not moving away from us through normal motion, but they are getting further away from us due to the expansion of the universe: the expansion of space itself. This will be discussed later in this book.

There are many redshifts found in the universe. There is redshift related to radial motion, there is gravitational redshift around massive objects, and this defines a third type of redshift known as **Cosmological Redshift**, due to the **Expansion of Space**.

This Cosmological Redshift only affects things very far apart. It does not affect objects that are gravitationally bound to each other: stars in a galaxy, galaxies in a galaxy cluster, or objects on the Earth.

**Hubble's Law** states that the universe is expanding. This implies that if we reverse time, and travel backwards, they were closer together in the past. If we continue to travel back in time they must have been in a single point in space and time: the Big Bang. This too will be discussed in later chapters.

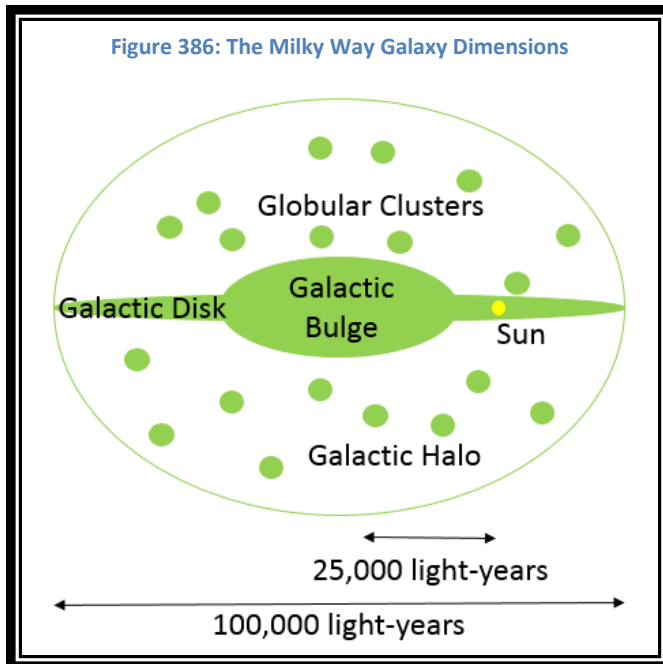
Hubble's Law is what we use to measure the distance to the most distant objects. By measuring the red shift of a galaxy we are able to determine its distance.

*Distant Galaxies  
are Receding from  
the Milky Way*

*Recession Velocity  
is Directly Related  
to Distance*

## Component 149 – Milky Way Galaxy Dimensions

Our galaxy is the Milky Way Galaxy. It is a large barred-spiral galaxy. As seen from dark skies, it appears as a river of spilled milk. It is thousands of stars that are too faint to see individually with the unaided eye, but that together create a glow that stretches across the sky. The river of milk is interrupted by many dark nebulae.



*The Sun is 25,000  
Light-Years from the  
Central Black Hole*

*The Milky Way  
Galaxy is 100,000  
Light-Years Across*

## Component 150 – Mass of the Milky Way Galaxy

We use radio telescopes to identify where the stars are in the Milky Way Galaxy. But we want to know more than their current position. We want to know how massive the stars are. We know that from Newton's Laws we can calculate the mass of the galaxy based on an object's orbital period (**Rotation Velocity**) and the semi-major axis of its orbit.

### Mass Based on the Sun's Orbit

The Sun orbits the Milky Way Galaxy's core in 225 million years. Our distance from the core is 8,000 parsecs. When you convert to AU and plug in these values, you get a mass of 88 billion times the mass of the Sun. The mass of the Milky Way Galaxy, based on measurements using the Sun is the mass of the material inside the Sun's orbit. There is additional mass in the Milky Way outside of the Sun's orbit.

Equation 25: Mass of the Milky Way Galaxy

$$M_{\text{Solar Masses}} = \frac{(\text{Semi-Major Axis (in AU)})^3}{(\text{Orbital Period (in yrs)})^2}$$

### Total Mass of the Galaxy and Rotation Curves

To calculate the total mass you would need to do the same calculation for the object that is furthest from the core. By using radio telescopes, astronomers are able to measure dust and gas at different distances from the galactic core. When you plot this data, you get a rotation curve for the Milky Way Galaxy. This is shown in the gray curve in Figure 453. The other lines are for comparison. The blue is what Kepler's Laws would predict. The green is the curve you would get for a solid body, and the red is where the velocity is held constant. The fact that the Milky Way **Galactic Rotation Curve**

actually approaches the flat velocity implies that there continues to be additional mass beyond what we can see. This mass is what we refer to as **Dark Matter**, and is discussed further in Component 160.

Figure 387: The Milky Way Galaxy Rotation Curve

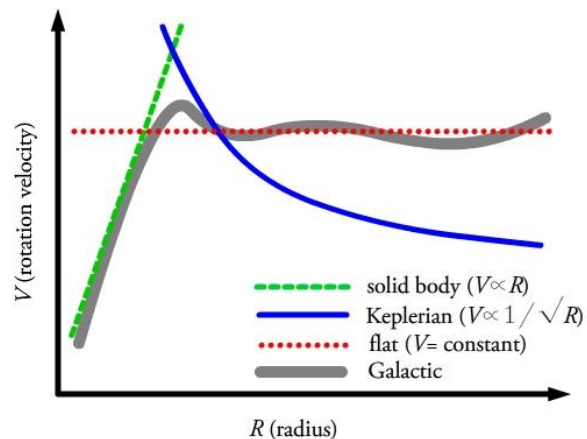


Diagram by LemonBalmer

## Component 151 – Milky Way Structure

The Milky Way Galaxy is a Barred-Spiral Galaxy. Since we are within the galaxy, the only way to see the entire structure is to generate it on the computer based on **Radio Telescope** data.

Figure 388: The Milky Way Galaxy Structure

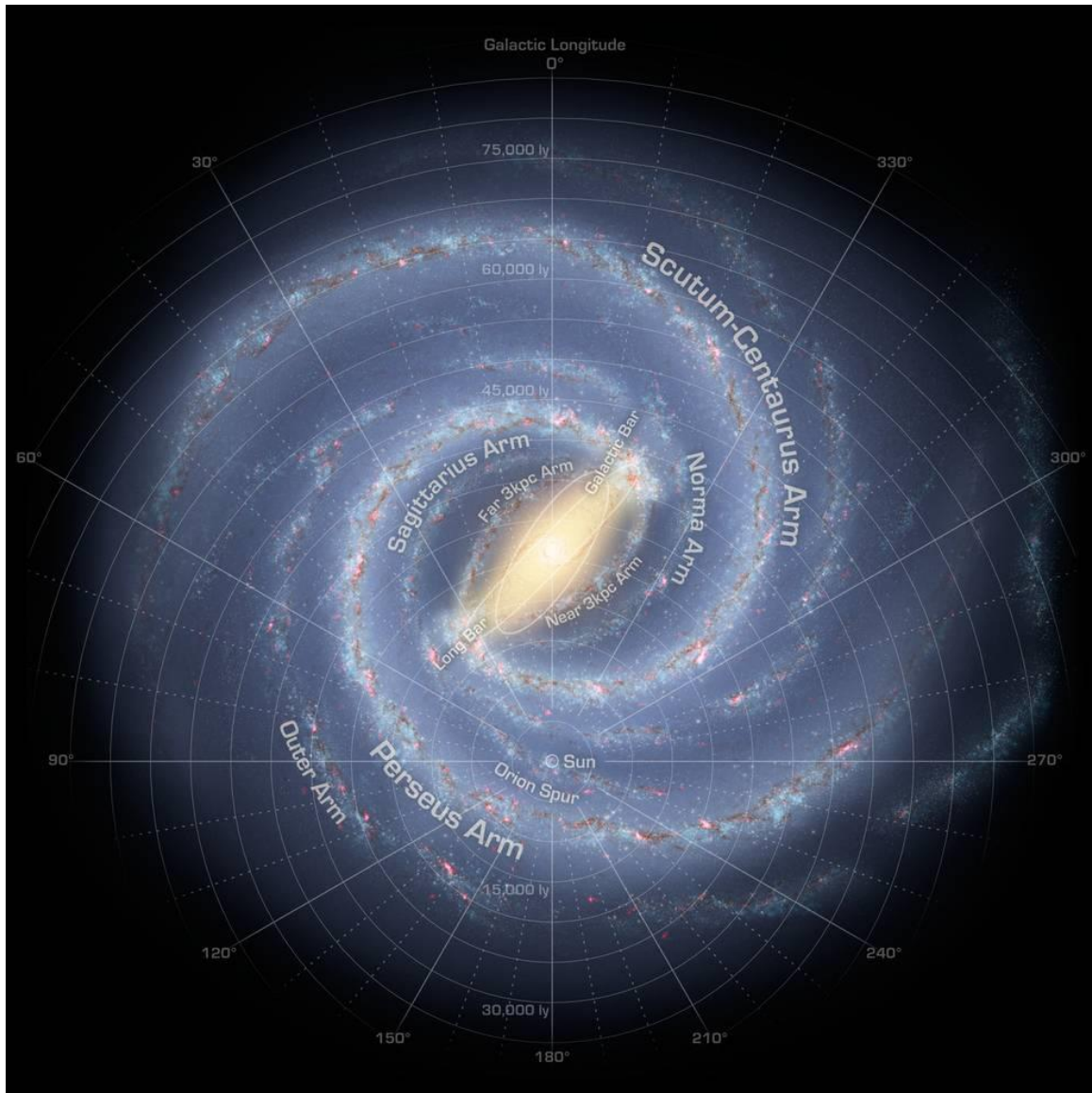
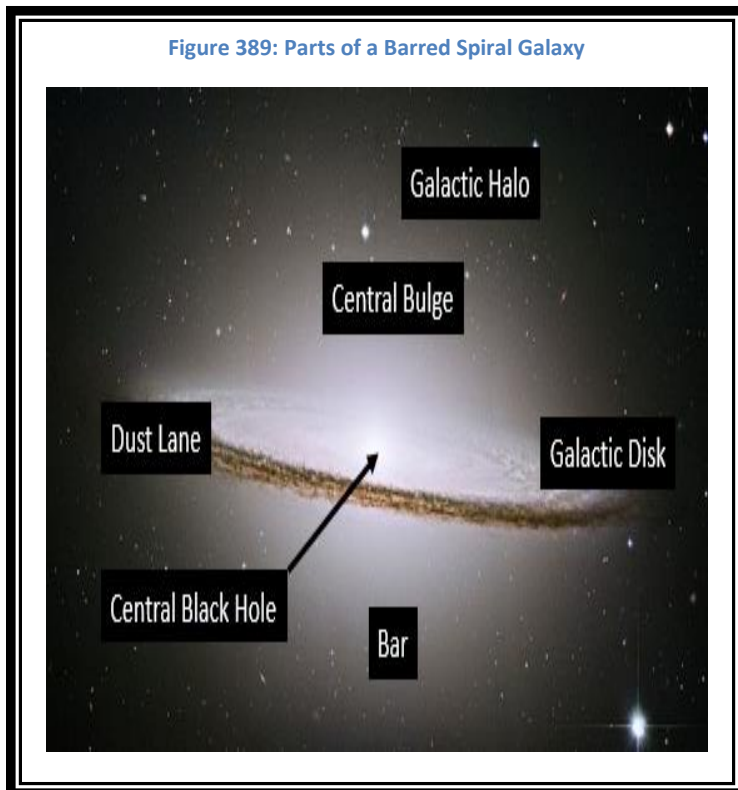


Diagram Built by NASA from the WISE Mission data

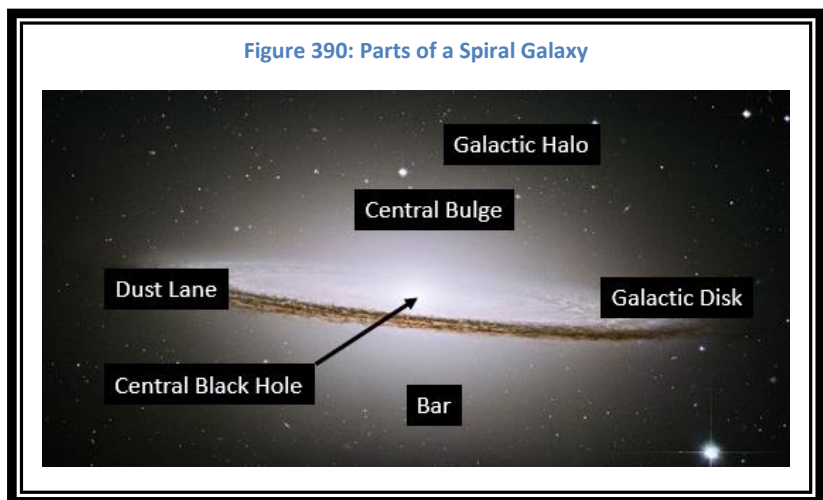
For more information on the WISE Mission, visit: <http://www.nasa.gov/wise>

The Sun is located on the **Cygnus-Orion Spiral Arm** on the **Orion Spur**. The galaxy has two major arms, the **Scutum-Centaurus Arm** and the **Perseus Arm**. Additionally there are many minor branches throughout the disk. The Sun is located 25 thousand light-years from the core, in a galaxy that spans 100 thousand light-years across.

The pink regions are Emission Nebulae that are star forming regions in the disk. There are many Open Star Clusters also found in the disk and Globular Star Clusters located in the Galactic Halo. As the galaxy ages, star formation moves **outwards**.



*The Sun is  
Located on the  
Orion Spur*

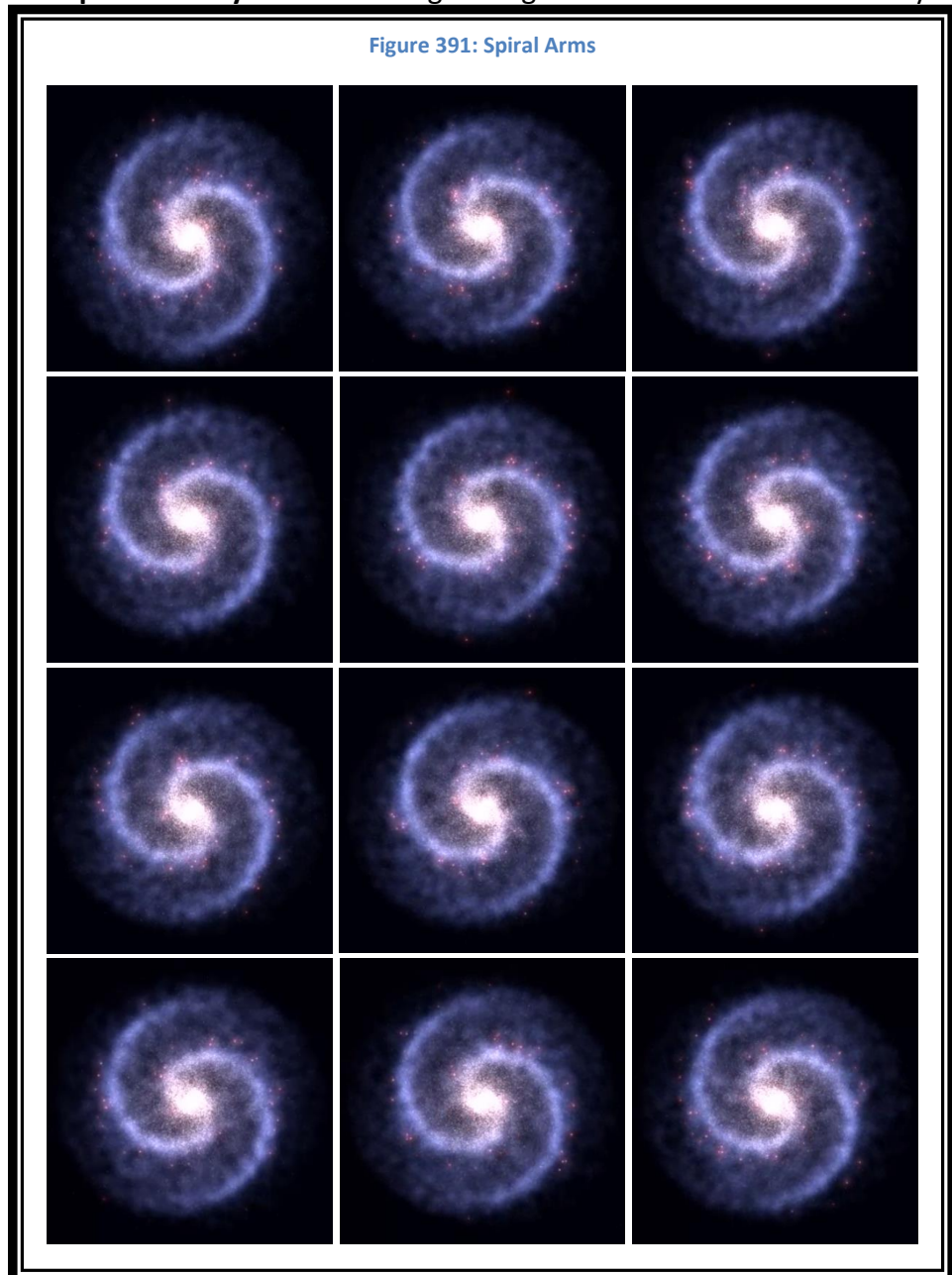


## Component 152 – Milky Way Spiral Arms

Spiral Galaxies have Spiral Arms. These arms contain billions of stars. Each star, based on its mass, orbits the center of the galaxy at a specific velocity. Just like the planets in our solar system, those closer to the center orbit more quickly than those farther out. If the spiral arms were static, then they would tighten over time as the inner stars completed more orbits than the outer stars. From what astronomers have observed this is not happening. There must be a different mechanism preserving the spiral arms. Figure 457 shows a sequence of drawings by Ingo Berg that shows how **Spiral Density Waves** moving through the disk could cause stability in the spiral

structure while explaining the creation of new stars. New star formation is taking place on the leading edge of the arms and old stars are dying off on the back side of the arms. The dust clouds in the disk as well as the emission nebulae are moving counterclockwise through the images, though the arms persist.

Astronomers are not sure how the spiral arms originate, but they appear to be associated with the ends of the bar as shown in these images.



## Component 153 – Milky Way Formation

The Milky Way Galaxy is a very complex structure. There are several theories on how the Milky Way Galaxy and other spiral galaxies formed. It is likely that its current shape was influenced by repeated **mergers** with other galaxies over billions of years. But there is also some evidence that early galaxies would have formed from the dust and gas in space.

The first stars would have formed in the galactic nebula. There would have been no structure and no uniform motion. They would have randomly orbited the center of mass. Over time, the cloud would have begun to collapse and an overall rotation would have begun to emerge. This rotation would cause the cloud to collapse further. Most of the gas and dust would have fallen into the galactic plane that was forming. Old stars with their random orbits would have been left behind in the halo and eventually formed into globular clusters. New stars would form from the dust and gas in the disk and would have orbits that match the overall rotation of the disk. This process is very similar to the one believed to have formed stars and their planets.

Studies indicate that it is likely that dust and gas continue to fall onto the galactic disk. The models indicate that the material of stars is not as high in metallicity as it should be. This could be caused by this influx of extra material from the halo.

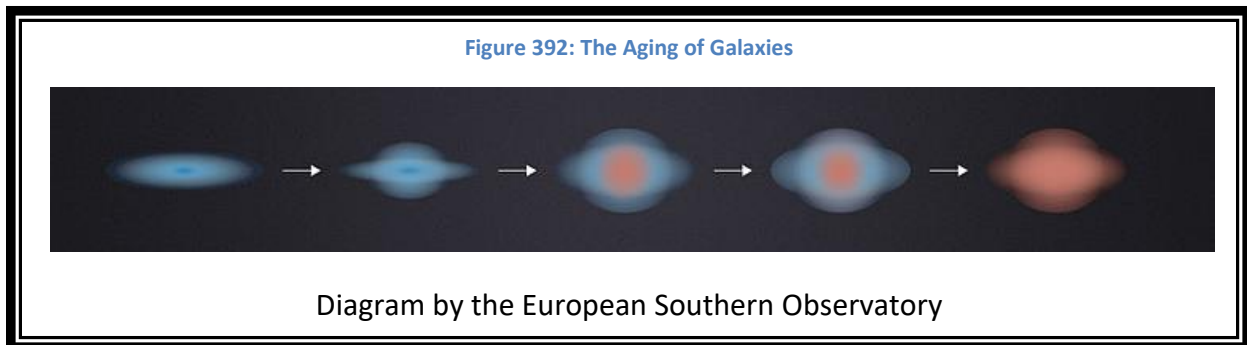


Figure 458 shows how star formation diminishes as a galaxy ages. Galaxies found early in the life of the universe are on the left. The blue color signifies major star formation activity. The galaxy on the right shows star formation in this galaxy billions of years later. The red signifies regions of no star formation activity.



## Component 154 – Globular Clusters

In addition to Open Star Clusters, the Milky Way Galaxy is also home to many Globular Star Clusters.

### Age

Globular Star Clusters are as old as the Milky Way

Galaxy. They formed at about the same time. They are composed of thousands to **millions of old** stars and resemble snowballs of stars (roughly spherical). There are approximately 150 known globular clusters in the Milky Way Galaxy. The galaxy M87 has over 16,000.

You can tell the age of a **Globular Clusters** by plotting the stars on an HR-Diagram. The Globular Cluster's **age** can be estimated by where the stars leave the Main Sequence: The **Main Sequence Turn-Off**. The largest stars on the Main Sequence are the next ones to leave; as a function of their size they have very specific lifetimes on the main sequence. For example, if the turn-off point occurs at a star the size of the Sun, then you would know that the age of the Globular Star Cluster is approximately 10 billion years old.

Sometimes when we plot the stars of a Globular Star Cluster we see a few large blue stars in the diagram (upper left of the Main Sequence in Figure 460). These are called **Blue Stragglers**. They did not form at the time the Globular Cluster formed, but are late arrivals. They probably formed by the merger of two smaller stars.

*Globular Clusters contain thousands to millions of stars*

Figure 393: M13 - The Hercules Globular



Figure 394: Main Sequence Turnoff

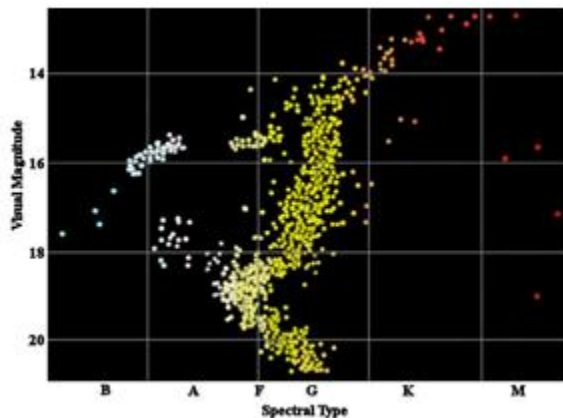
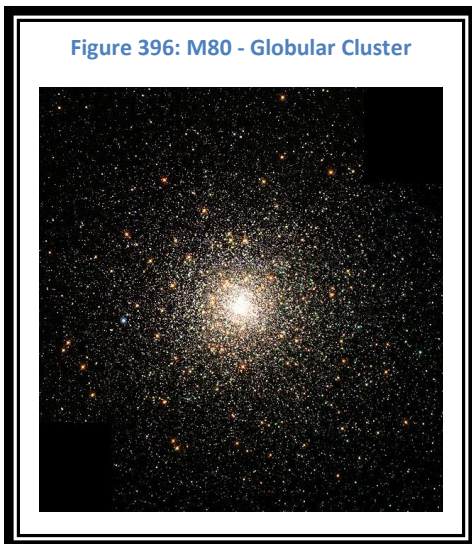
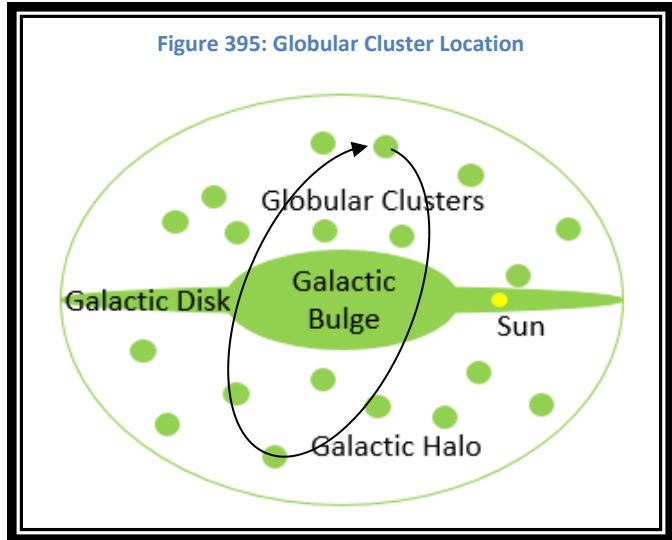


Diagram by Roberto Mura

*Blue Stragglers formed much later than the cluster*

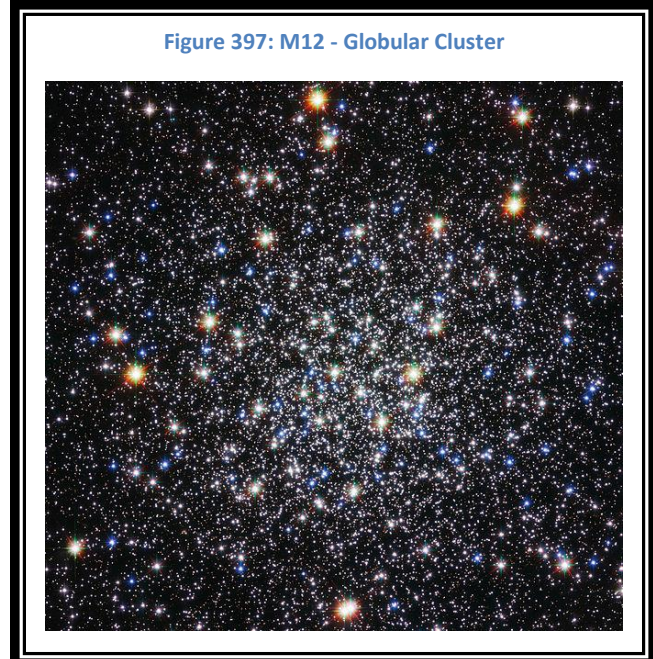
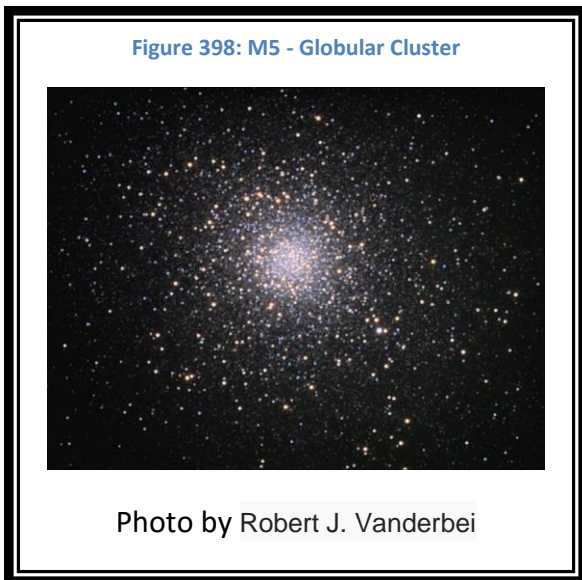
### Location and Orbit

The Globular Star Clusters are located in the Galactic **Halo**. Their orbits are random, but they do orbit the center of the galaxy. Their paths take them through the galactic plane. When this occurs they may cause additional star formation by disturbing dust clouds, and gravitational tugs by other stars may make the cluster a looser group of stars.



### Concentration Class

Globular Star Clusters are classified by their **Concentration Class**. This is a measure of how compact the central core is. Class I is very dense and tightly packed. Class XII is very loosely packed.

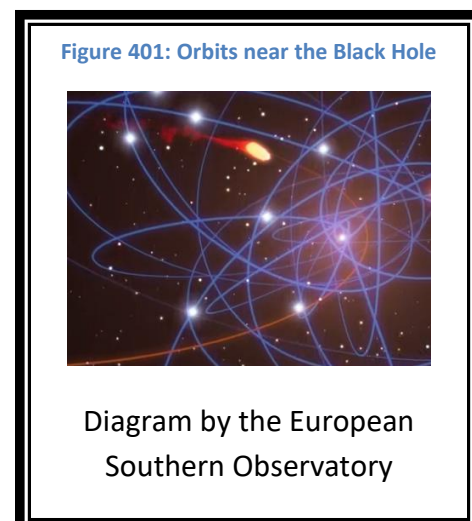
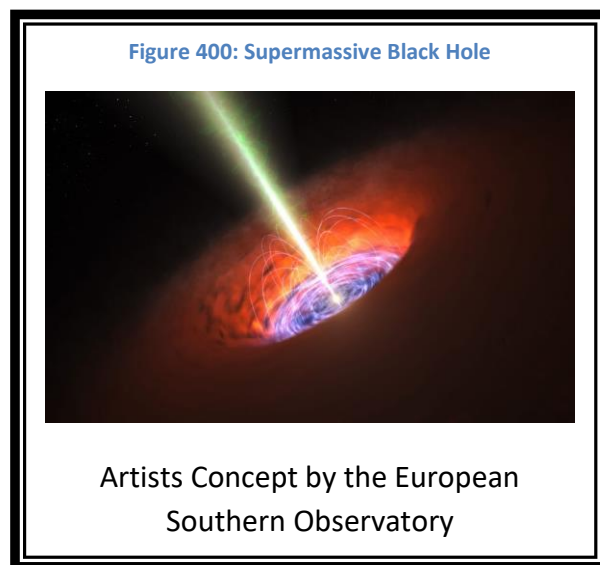
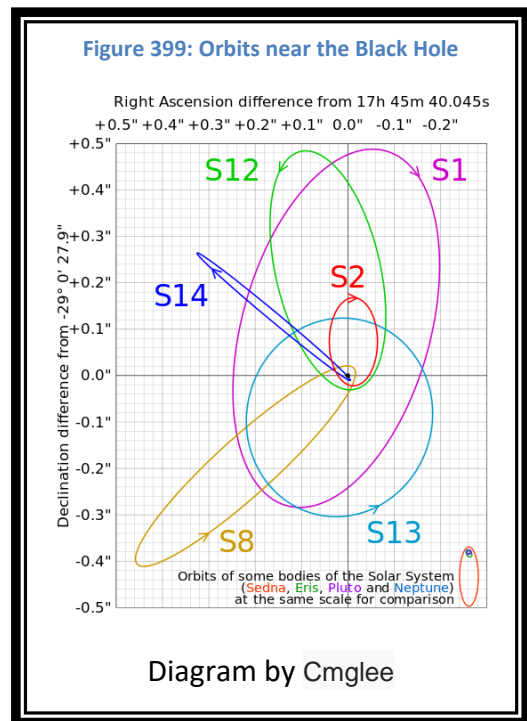


## Component 155 – Supermassive Black Hole

### Theory

At this time, astronomers have concluded that many, if not most, galaxies have a **Supermassive Black Hole** in their core. These are much more massive than Stellar Black Holes. They may have a mass of millions or billions of **solar masses** and are the result of countless galactic mergers over billions of years.

We can't see Black Holes. They do not emit their own light and they are surrounded by much dust and gas which obscures the visible radiation emitted from their accretion disks and jets. We locate them by the behavior of other nearby objects. This may be binary companions for stellar black holes, or stars close to the galactic centers. We see objects orbiting a very massive object yet are unable to see the object itself at any frequencies. To see this detail through the intervening dust and gas we use radio telescopes. Figure 465 shows **orbits of stars** that we see. We do not see the object that they are orbiting, but by the nature of their orbits we are able to determine that it is 4,100,000 solar masses. Figure 467 shows the paths of the orbits of those stars.



We also see evidence of jets being emitted from the invisible object in the cores of galaxies (Figure 468).

There are also Intermediate Mass Black Holes. They are much rarer. Some have been found in the hearts of small galaxies and even larger globular clusters.

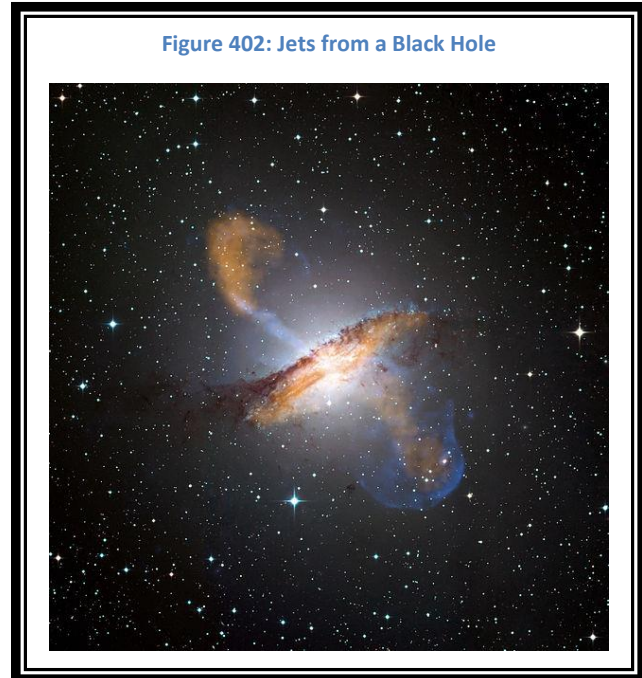
The mass and size of the central bulge in a galaxy is directly proportional to the mass of the central black hole.

### Structure

Supermassive Black Holes are identified by the activities detected in their proximity.

There are stars that orbit the black hole in paths and with velocities that indicate the mass of the central object.

The central black hole is not visible, but an accretion disk can be seen close to the center. There are often jets of material being emitted from near the center along the magnetic poles. This accretion disk of hot material is surrounded by a torus of dust and gas.



### *Parts of a Black Hole:*

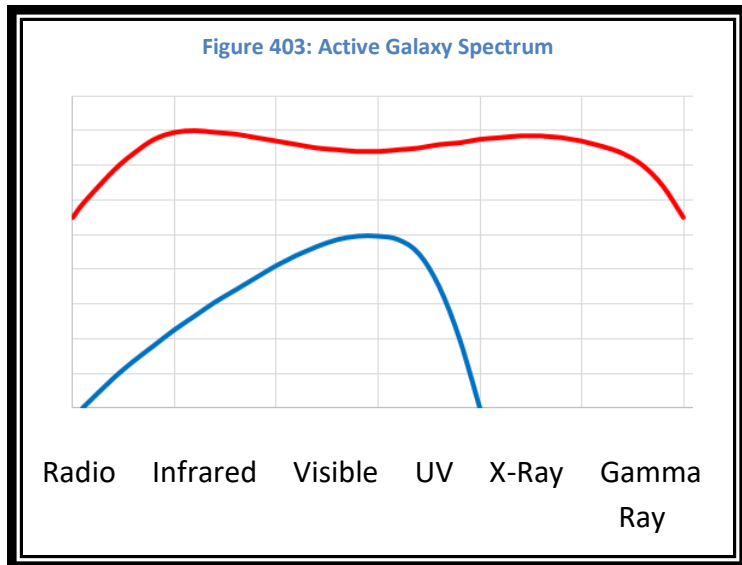
- *Singularity*
- *Event Horizon*
- *Accretion Disk*
- *Dusty Torus*
- *Jets*

### *Black Hole Measurements:*

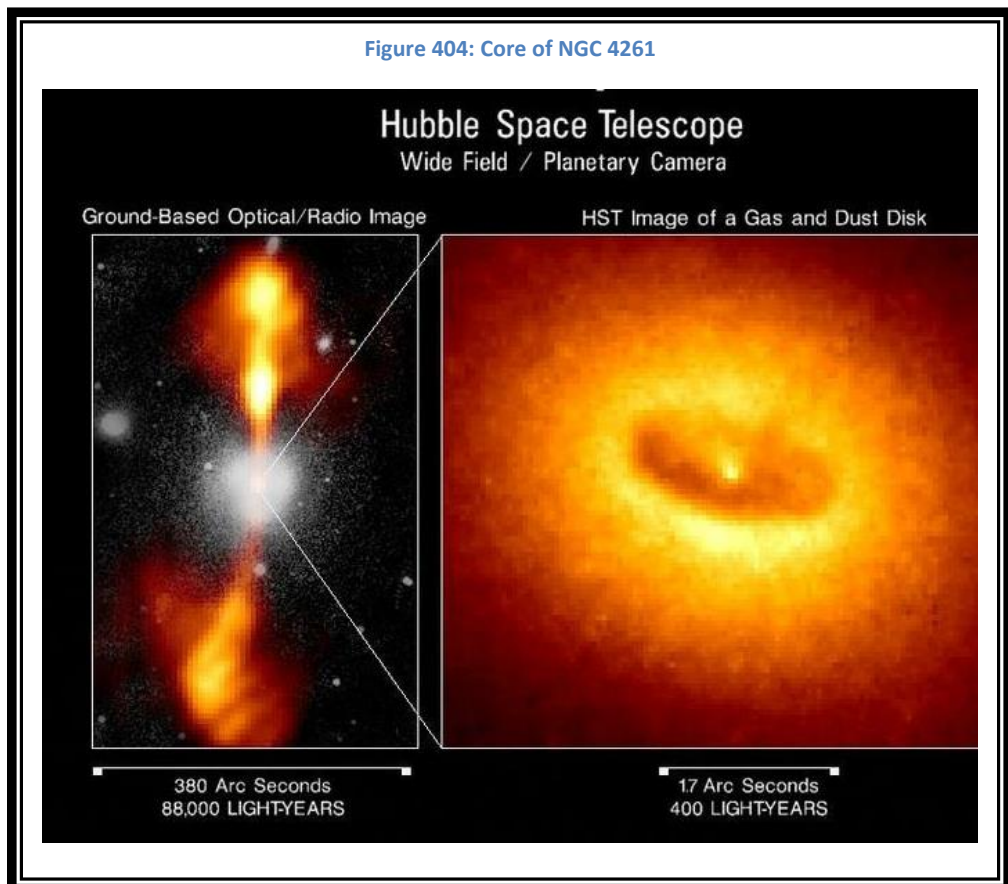
- *Mass*
- *Charge*
- *Spin*

## Component 156 – Active Galaxies

Some galaxies generate more energy than normal. They are termed **Active Galaxies** and have **Active Galactic Nuclei**. Active Galactic Nuclei have a spectrum that is quite different from a stellar Blackbody Curve. A normal galaxy's spectrum is the sum of all of its stars and resembles a stellar blackbody curve (Blue curve in Figure 469). An Active Galaxy has an Active Galactic Nucleus and displays a very different **Galactic Spectrum** (Red curve in Figure 469).



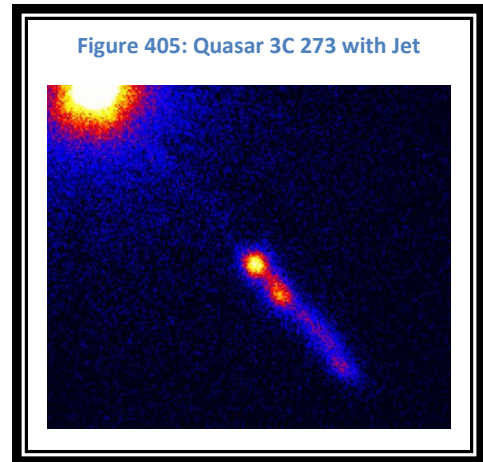
There are three general classifications of Active Galaxies: **Quasars**, **Seyfert Galaxies** and **Radio Galaxies**. This increased activity in the galaxy's core is believed to be due to a high level of material merging with the central black hole during galaxy **mergers**. As material is pulled apart as it approaches the central black hole, charged particles are ejected from the accretion disk by the strong magnetic fields created by the rotating black hole.



## Component 157 – Quasars

### History

**Quasars** (QUAsi-StellAr Radio Sources) were first discovered by **radio telescopes** in the 1950s but no correlations with known visible objects were available. Quasars contained broad spectral lines that were not associated with any known elements or processes. In 1960, the first Quasar was associated with a faint visible light object. The second one was observed during an occultation by the moon in 1962, and in 1963 it was determined that the broad spectral lines observed were hydrogen-alpha spectral lines with a large redshift of 15.8. Once this was discovered, then it was possible to identify the many similar objects that had been identified.



### Details

Quasars are dense cores of interacting proto-galaxies. The outbursts are from the merger of the two supermassive black holes. Figure 471 show an image from the Chandra X-Ray Telescope showing a **jet** from the core of Quasar 3C 273.

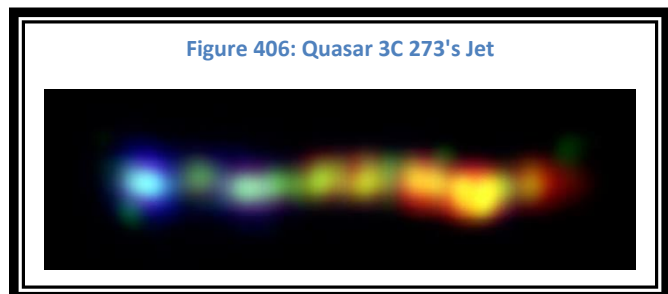
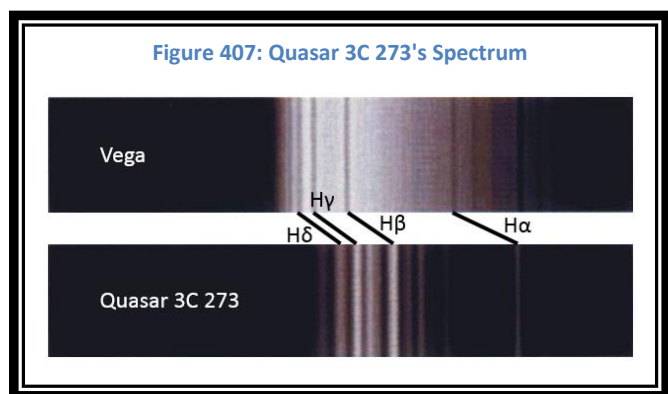


Figure 472 shows the jet as a combined image from Chandra (X-Rays in blue) through Hubble (Visible in Green) to Spitzer (Infrared in red). This shows how the energy of the jet diminishes as it moves away from the Quasar.

Figure 473 shows the spectrum of Quasar 3C 273 compared to relatively close star Vega. The redshift indicates that the Quasar is very far away. The broadening of the emission lines indicates that there is a great deal of turbulence.



Quasars occurred between 13 and 10 billion years ago, with a peak 12 billion years ago. This is called the **Quasar Epoch**.

## Component 158 – Seyfert Galaxies

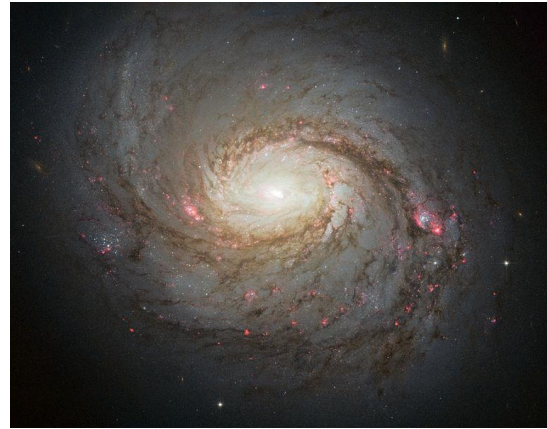
### History

**Seyfert Galaxies** were identified in 1943 as galaxies that resemble **Normal Galaxies (Spiral Galaxies)**, but their cores radiate a significant amount of radiation across the spectrum. The greatest amount of radiation is in the infrared. 10% of all spiral galaxies appear to be Seyfert Galaxies.

### Details

Radiation from the cores of Seyfert Galaxies is from the merger of two supermassive black holes, the same mechanism as in Quasars. Similar activities can be seen in the core of our galaxy, but Seyfert Galaxies are thousands of times more energetic.

Figure 408: Seyfert Galaxy - M77

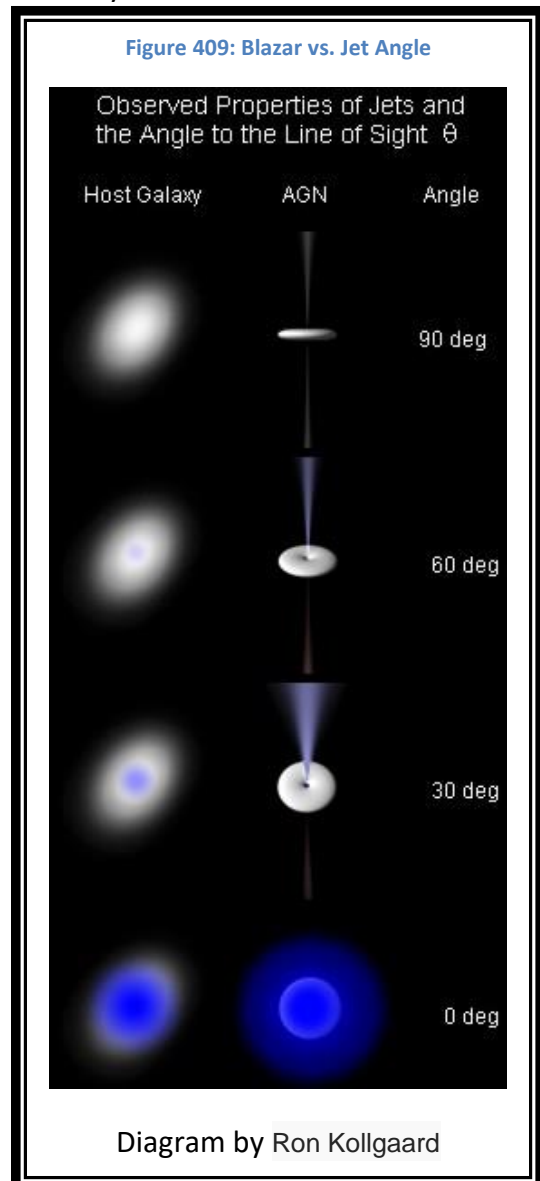
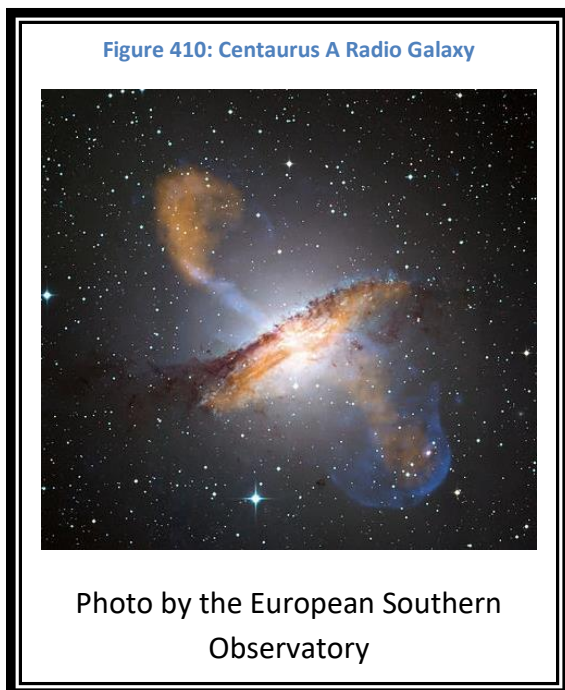


## Component 159 – Radio Galaxies

**Radio Galaxies** have very Active Galactic Nuclei as well. They are characterized as having very high emissions in the Radio part of the spectrum. The Radio emissions are caused by the interaction of high energy material in jets escaping from the core of the galaxies. These jets interact with material in the surrounding space and cause it to radiate in the Radio spectrum.

If we are seeing the galaxy from the edge we can clearly see the two **Radio Lobes** as shown in Figure 476. But when we are seeing the galaxy from the pole, we see a galaxy that radiates strongly in the Radio spectrum and appears to be core-dominated. In this orientation we are looking directly into the lobe. If we are looking directly down at the jet, we see an intense emission of X-Rays and Gamma Rays. This type of Radio Galaxy is also called a **Blazar**. The emissions are blueshifted. We know of a few hundred Blazars at this time.

The angle at which we are observing the jet impacts whether it is a Blazar. Figure 475 shows the relationship of this angle to the effect caused by relativistic beaming.





## Component 160 – Dark Matter

When astronomers study the behavior of galaxies and galaxy clusters, there appears to be more gravity than is expected. This means that there is more mass than can be seen. Astronomers do not know what it is, but only see the effect of its gravity. This matter is referred to as **Dark Matter**.

### Galactic Rotation Curves

The motion of a star as it orbits the center of its galaxy is a function of the mass within its orbit. As you move to the outer reaches of the galaxy, you would expect the amount of matter to decrease and therefore the rotation speed should also decrease. But the **Galaxy Rotation Curve** for the Milky Way continues to increase gradually. This implies that there is much more mass in the outer galaxy that we can see.

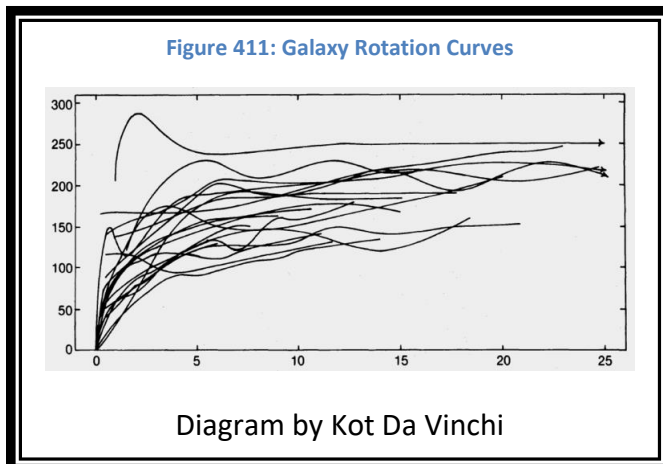


Figure 477 shows the expected curves for a group of galaxies.

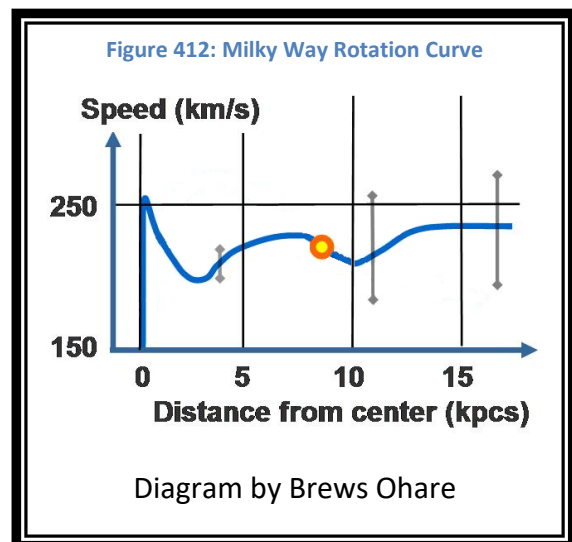


Figure 478 shows the rotation curve for the Milky Way Galaxy. The expected drop-off is not present. The small circle is the location of the Sun. This clearly shows that there is additional matter in the outer reaches of the Milky Way Galaxy.

### Dark Matter Halos

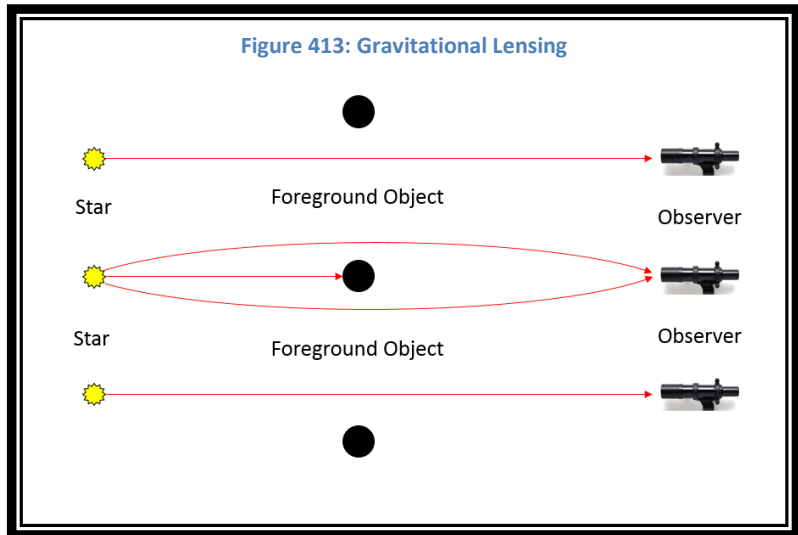
Spiral Galaxies show that there appears to be a halo of Dark Matter outside of the galaxy's halo. This appears to be true for Elliptical Galaxies as well.

## Gravitational Lensing

Very faint or invisible material passing in front of a distant star can cause the star to brighten while the matter is in front of the star. This is called **Gravitational Lensing**. Figure 479 shows how this effect works. When the object is between the observer and the distant star, light curves around the matter and multiple paths can all reach the observer making the distant star appear brighter.

## Galaxy Clusters

There appears to be even more Dark Matter in the vicinities of Galaxy Clusters. By studying the collisions of Galaxy Clusters, astronomers are able to map the Dark Matter near the Galaxy Clusters. Figure 480 shows the results of their analysis for 6 different collisions. The blue in the images represents the mapping of the Dark Matter.



## Component 161 – Galactic Mergers

Looking at galaxies there appears to be a common theme. One of the major influencing factors in galaxy evolution appears to be **Galactic Mergers**. There are many examples of galaxies merging. By examining galaxies at different phases of their mergers we can determine the likely outcome of mergers of different types of galaxies. Astronomers then model these mergers on computers.

When two large spiral galaxies collide, the result is likely to be a giant elliptical galaxy. The spiral arms would be absorbed into the new galaxy. When a spiral galaxy merges with a small

Figure 415: The Antenna Galaxies



Figure 416: The Whirlpool Galaxy – M51



galaxy, the result is likely to be a giant spiral galaxy.

During the merger process, which may take billions of years, there are often streamers of stars connecting the galaxies as the cores spiral towards each other. Many new stars will form, but there will be very few stellar collisions.

In approximately 3 billion years the Andromeda Galaxy and the Milky Way Galaxy will begin the dance of our merger. The final result may be a giant elliptical galaxy.

Figure 418: Other Galaxy Mergers

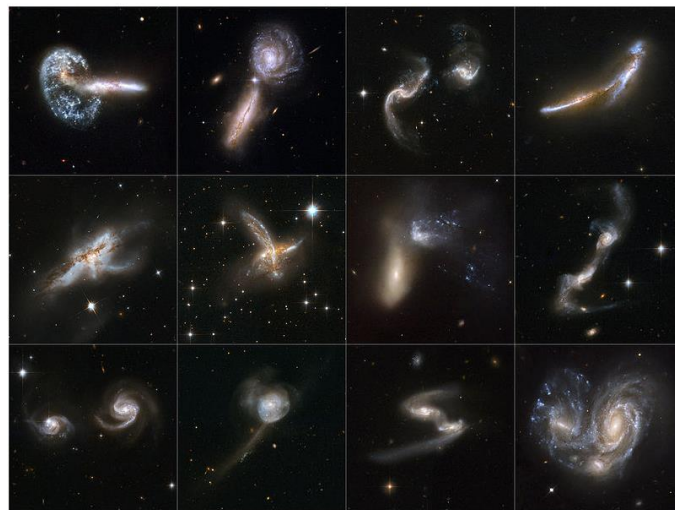
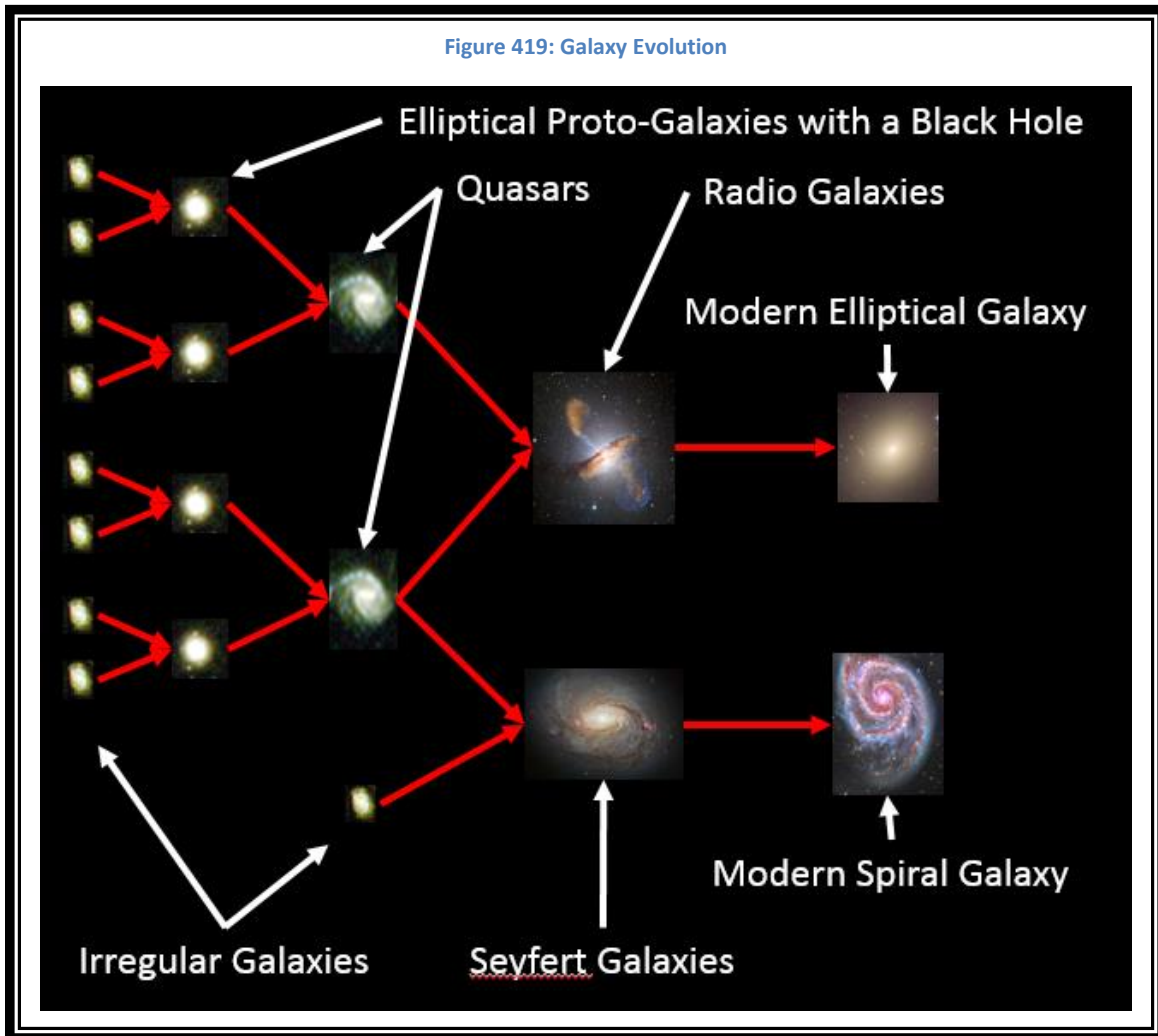


Figure 417: NGC 2207 and IC 2163



## Component 162 – Early Galactic Evolution

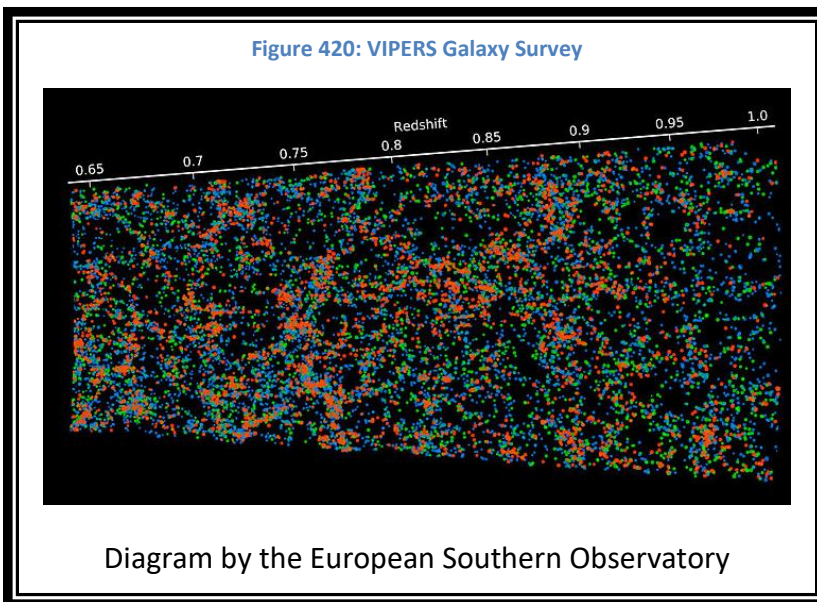
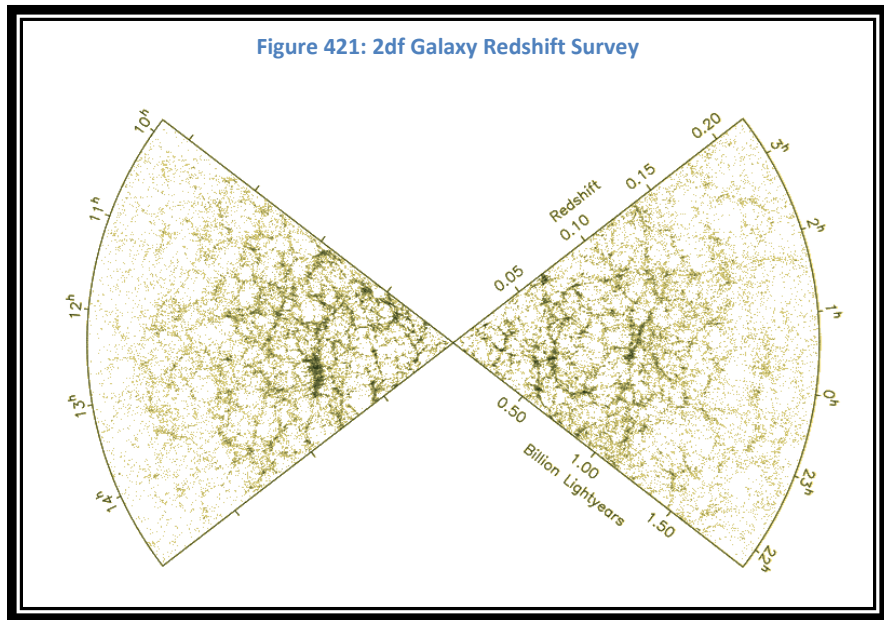
When we image galaxies, we see them from various points in the past. By piecing together what we see at different times we are able to piece together the process through which galaxies appear to evolve.



Galaxies forming soon after the big bang would have been small irregular galaxies. When these galaxies merged they would form dwarf elliptical proto-galaxies with central supermassive black holes. When these galaxies merged they would form Quasars. Mergers between two Quasars would produce a Radio Galaxy. A quasar and an irregular galaxy would produce a Seyfert Galaxy. As they settle down, Radio Galaxies would become modern elliptical galaxies. Seyfert Galaxies would become today's spiral galaxies. This process is shown in Figure 485.

## Component 163 – Galaxy Surveys

Telescopes have been used to take **surveys** of galaxies. These surveys can tell us the distribution of galaxies and this in turn can tell us about the larger structure of the universe. There is too much space to have a complete picture of the entire visible universe, but by sampling different areas we can make assumptions that extend



those areas we study.

Based on the detected **redshifts** for galaxies we are able to determine their distance. This can then be charted to show the distributions.

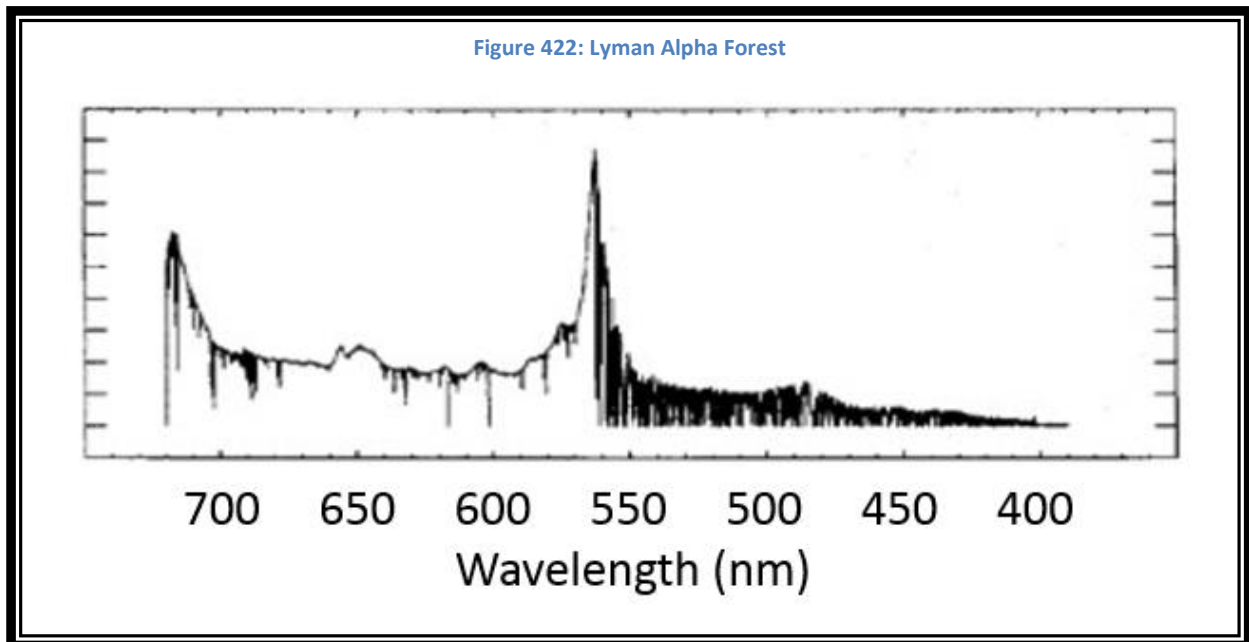
We see **Filaments** where galaxies clump into lines, and **Voids** where there appear to be few galaxies. One significant filament is the **Sloan Great Wall**. This is one

*There is no evidence of structures larger than 300 Mpc across*

of the largest structures known in the universe. It occurs between 300 and 400 Mpc away and is almost 300 Mpc in length. The largest voids appear to be approximately 100 Mpc in diameter.

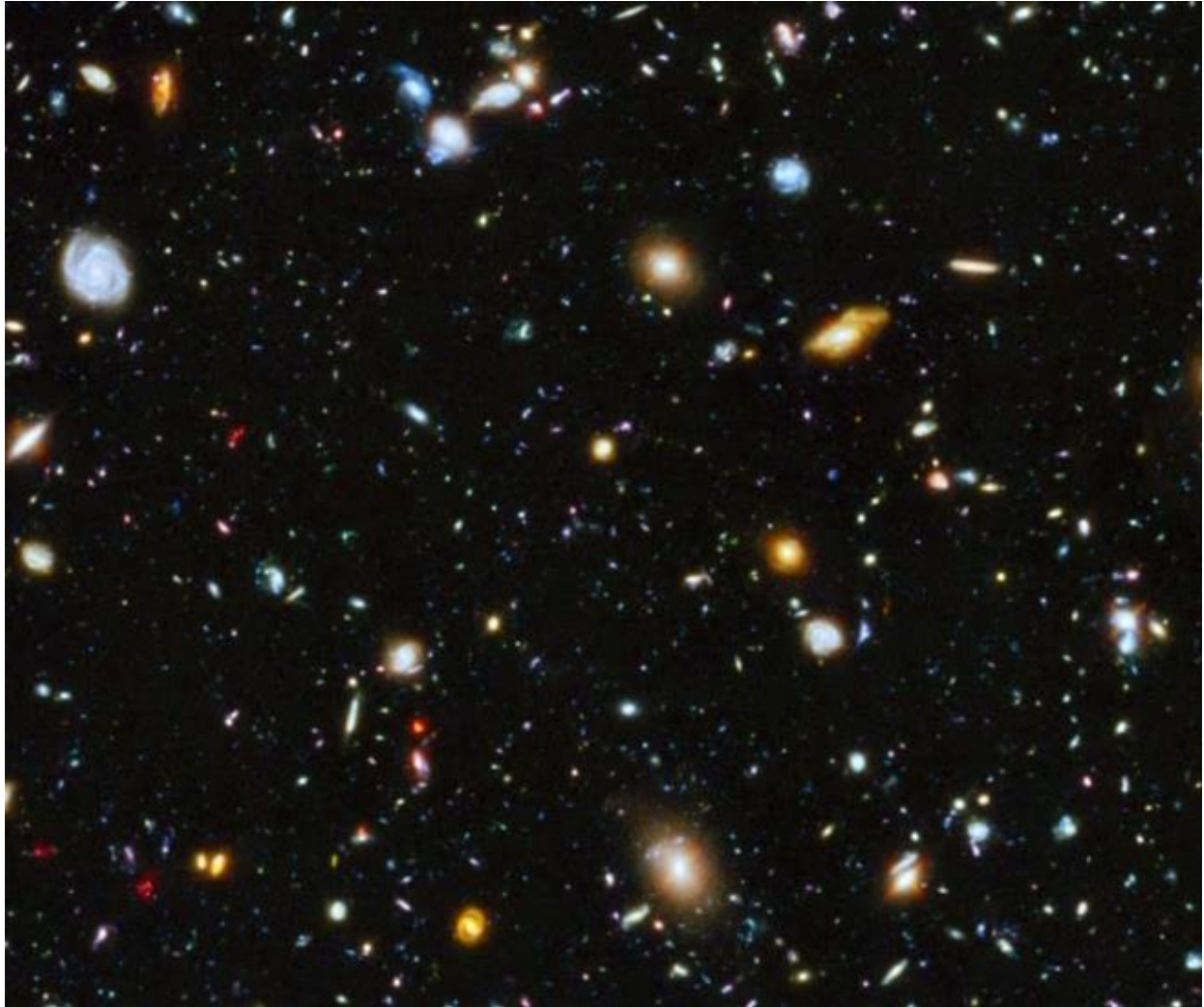
## Component 164 – Lyman Alpha Evidence

Spectroscopy is a very useful tool for learning about celestial objects as discussed in early Components. But astronomers have found another use for the spectrum of Gamma Ray Bursts. They noted that the spectra of Gamma Ray Bursts have multiple lines for the Lyman-Alpha spectral line. These lines are caused by absorption of light as it passes through dust clouds (**Nebulae**) at different distances and are often referred to as the **Lyman Alpha Forest**. Each absorption line corresponds to a specific redshift related to the distance of the dust clouds. The tallest peak in Figure 488 represents the ultraviolet absorption line of the original light. The successive lines to its right are the absorption lines created by the dust clouds. The wavelength of the line originally was 122 nm. This effect has also been observed in the spectra of distant Quasars



This data was collected as part of NASA's SWIFT Gamma Ray Burst Mission.

**\*\*\* SECTION VII. ASTRONOMY – COSMOLOGY**



## Component 165 – The Cosmological Principle

### Cosmological Principle

From the surveys discussed in Component 163, there are some observations and generalizations can be made. There is a **Cosmological Principle** that appears to be true in the visible universe. It is composed of two parts: The Universe is **Homogeneous**, and the Universe is **Isotropic**.

### Homogeneous

Homogeneous means that on a large scale (cubes 300 Mpc on a side) every cube is the same as every other cube. Although differences could be seen on smaller scales, at this large scale the structures seen would be very similar in each cube. There would be filaments and voids. There would be great walls of galaxies.

### Isotropic

Isotropic means that no matter in which direction you look, you will see the same structure and contents. You would see the same galaxy structures. This assumes that you are beyond the Milky Way Galaxy and other local concentrations.

### Assumptions and Conclusions

The Cosmological Principle assumes that the **Laws of Physics** are the same everywhere in the universe. It also assumes that directions where we have not completed detailed surveys will extend what we have seen in our surveys.

If the universe is Homogeneous, then there can be no **edges**. An edge would be different from the rest of the universe and a large cube containing an edge would be different than other cubes that do not contain an edge.

If the universe is Isotropic, then there can be no **center**. A survey of the universe from any place that is not the center would be different from those taken from the center. This would not be isotropic.

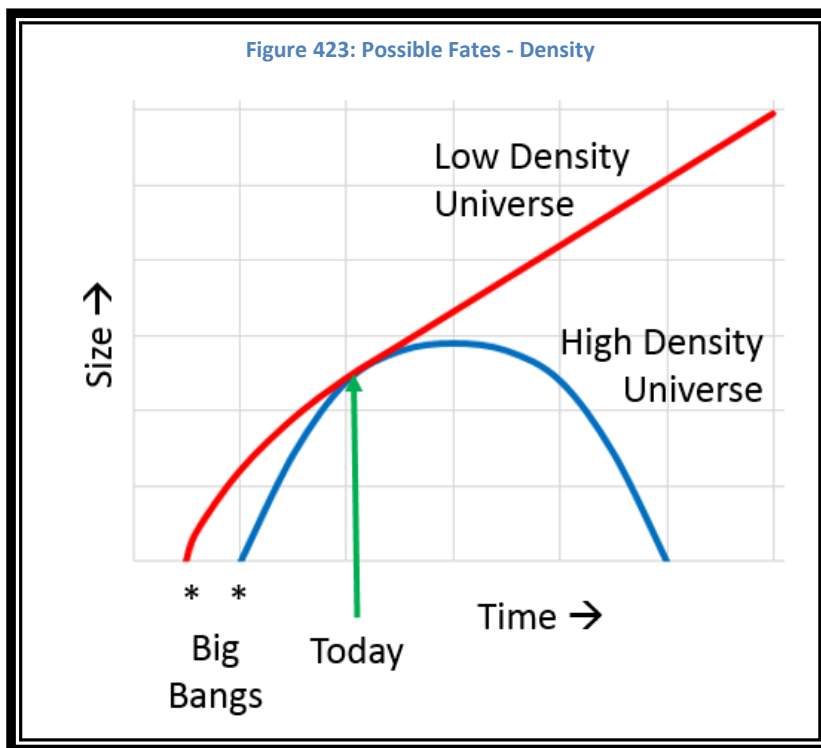


## Component 166 – The Ultimate Fate of the Universe

One question that astronomers and cosmologists want to answer is, “What is the ultimate fate of the universe?” Will the expansion slow down, begin to contract, and will the universe end in a Big Crunch? Will the expansion slow and stop? Will the universe expand forever?

### Density of the Universe

The answer depends on one thing, the **density** of the universe. If the density is high enough, then gravity will ultimately win, and the universe will collapse. If the density is too low, the



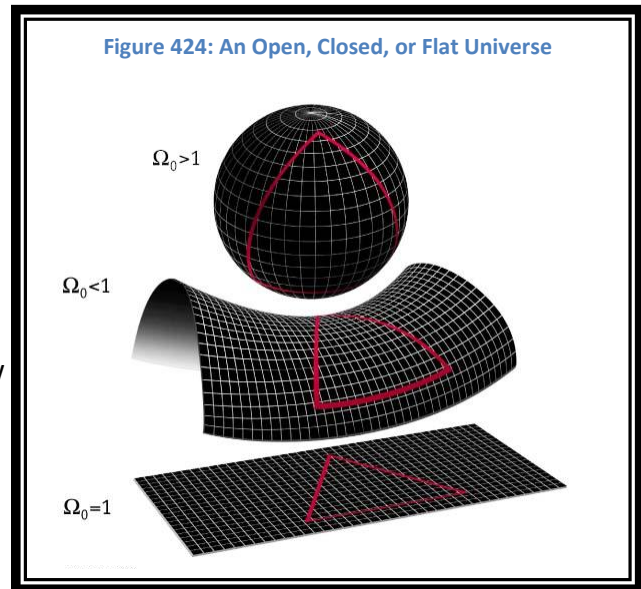
universe will continue to expand forever. If the density is at just the right value, the expansion will slow and the universe’s expansion will come to a halt and be stable. This last case is referred to as the **Critical Density**.

The possible fates of the universe are indicated by the two curves in Figure 489. For a low density universe, the red line shows the continued expansion of the universe. For a high density universe, the blue line shows the expansion and eventual

collapse of the universe.

## Geometry of the Universe

But, as we see from Einstein's theories, space can be warped by high mass objects. So too, space can be warped by the mass of the universe. A universe that is at the **Critical Density** ( $\Omega_0$ ) is a **Flat Universe** or a **Critical Universe**. Objects in a Flat Universe will follow Newton's Laws and behave as we would expect based on Euclidean Geometry. As we were taught, a triangle drawn in a Flat Universe will have angles adding up to  $180^\circ$ . In two dimensions this is like a flat sheet of paper.



But if the universe is a High Density Universe, then space will be curved and this is called a **Closed Universe**. The two dimensional equivalent would be the surface of a **sphere** such as the Earth. A triangle drawn on the surface of a sphere will have angles that total more than  $180^\circ$  (see Figure 490). To visualize this, start at the north pole. Travel south to the equator and turn eastward. This angle is  $90^\circ$ . Travel one quarter of the way around the world and turn back northward. This is another  $90^\circ$  angle. Stop when you get to the North Pole. You have finished the triangle, and the angle of this third corner is also  $90^\circ$ , for a total of  $270^\circ$ . This is much larger than the triangle in Flat Space. This geometry is Riemannian Geometry. The lines followed on the surface of the Earth are straight lines in this geometry.

In the case of a Low Density Universe, space is again curved but very differently and this is called an **Open Universe**. The two dimensional equivalent of an Open Universe is the shape of a **saddleback**. A triangle drawn on this space would have angles that total less than  $180^\circ$  (see Figure 490). This is Lobachevsky

Geometry.

*The expansion  
of the universe  
is accelerating*

## The Verdict

*We live in a slightly Open Universe*

It is apparent, from studying the red shifts of supernovae and Cepheid Variable Stars that the universe is indeed **expanding** and there is evidence that the expansion is accelerating!

But the universe must be very close to the Critical Density. If not, it would have already collapsed or distant galaxies would have already expanded beyond the visible universe.

## Component 167 – Olber's Paradox

A paradox is when the evidence shows something that is contradictory to a prediction made on sound reasoning. **Olber's Paradox** is an example.

If we assume that:

- The universe is **homogeneous**
- The universe is **isotropic**
- The universe is **infinite**
- The universe is **unchanging**

Then it follows that there are galaxies and stars in every direction. No matter where you look, you will eventually run into a star. This means that every spot in the sky has starlight. So this implies that the night sky should be as bright as the surface of the sun. This is obviously not reality. The sky is indeed dark at night.

Since there is a paradox, at least one of the assumptions must be incorrect. The first two, the Cosmological Principle, seem to be correct. Either the universe is not infinite, or it must be changing over time.

Figure 491 demonstrates how Olbers' Paradox works. In the middle of the forest, no matter in which direction you look you see a tree. The

closer ones are bigger (brighter), but even the more distant ones (dimmer) fill in all of the gaps.

Figure 425: Olbers' Paradox



Photo by Tom Harpel

*In a homogeneous, isotropic, infinite, and static universe, the entire sky would be as bright as the Sun*

## Component 168 – The Big Bang: What, When, & Where

*The Center of the Universe is Everywhere!*

Starting in 1917, Vesto Slipher noted that most galaxies were receding away from us. In 1927, using Einstein's equations in the Theory of Relativity, Georges Lemaître developed the equations to describe that expansion and the constant that defines the rate of expansion. In 1929, Edwin Hubble, confirmed the relationship and refined the value of the constant now known as Hubble's Constant ( $H_0$ ).

In 1927, Georges Lemaître also noted that if the universe is expanding now, then it must have been smaller in the past. If you trace backwards further, there is a point where all of the galaxies in the universe

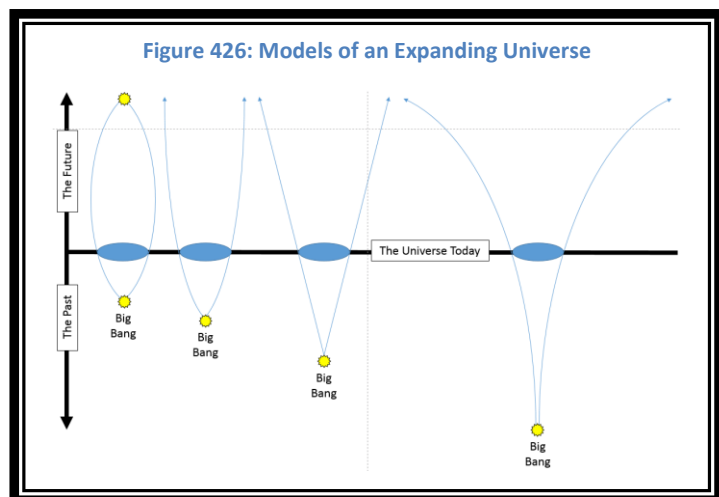
*The Big Bang is the start of Time, Space, all Matter, and Energy*

start as a single point, a **Singularity**. At the time, most scientists believed that the universe was in a Steady State. Einstein himself believed this to be the case.

In 1949 Fred Hoyle mockingly referred to this new theory as the Big Bang Theory. It turns out, that in light of the evidence, there appears to have been a **Big Bang** in the past and the universe is not in a Steady State. If the universe started as a singularity, then there is no center of the universe, or perhaps it is better to say that **everywhere** is the center of the universe.

The Big Bang is defined as the start of **time, space, matter, and energy**. Based on this definition, there was nothing before the Big Bang, and therefore nothing to discuss as far as what existed before the Big Bang. The answer is – nothing!

If we combine all of the information for the universe we see today, it is possible to determine when in the past everything was a singularity. This is the Big Bang itself. It appears to be 13.8 billion years ago.



## Component 169 – Evidence of the Big Bang

Like all scientific theories, once you have a theory, you have to make predictions and then observations to see if there is evidence that supports the theory.

### Hubble's Law

The first evidence that supports the Big Bang Theory is **Hubble's Law**. Observations of distant galaxies and quasars show that there is a significant redshift in their spectral lines. This shift in frequency corresponds very well to the relationship:  $v = H_0 * D$ . This evidence clearly demonstrates that the universe was smaller in the past and has a time of origin.

### Cosmic Microwave Background Radiation (CMBR)

The second piece of evidence is the **Cosmic Microwave Background Radiation**. The frequency of this radiation matches the theoretical frequency we should see for electromagnetic radiation when the universe first became transparent to photons. The fact that the radiation is essentially the same frequency everywhere in the universe means we are looking at evidence for a single event.

### Abundance of Primordial Elements

When astronomers look at materials left over from the early universe – materials that are devoid of heavy **elements** – they look at the abundances of the various elements. Theories of the Big Bang predict that at specific stages in the life of the early universe different elements were fused from the elementary particles. The expected concentrations for Helium-4, Helium-3, Deuterium, and Lithium-7 can be calculated, and the observed values correlate closely.

### Gravitational Waves

In September, 2015 Gravitational Waves were detected for the first time, supporting the Big Bang Theory. Since that time there have been at least two more positive detections. Gravitational Waves appear to move at the speed of light.

*Hubble's Law, the Cosmic Microwave Background Radiation, Gravitational Waves, and the Concentrations of Primordial Elements all Support the Big Bang Theory*

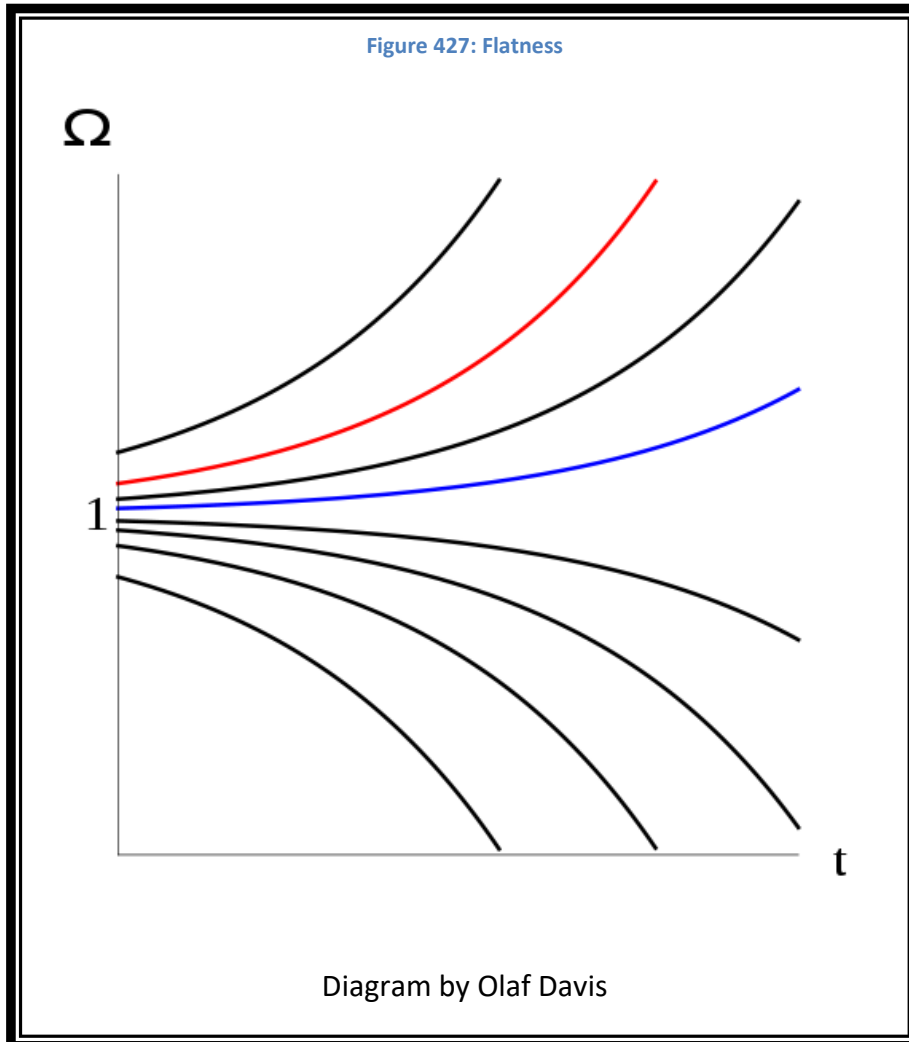
## Component 170 – The Flatness Problem

When astronomers study the curvature of the universe today, it is so close to being perfectly flat that any variation is imperceptible. This is the **Flatness Problem**. The total density of the universe is essentially at the critical value. Any deviation from a flat universe would quickly

grow and become significant.

Figure 493 shows that even a very slight deviation from the critical density quickly results in a significant increase over time.

This means that if the universe is a small bit away from flat, the universe would have recollapsed already, or the distant galaxies would have receded so quickly, that they would no longer be visible. Both of these scenarios are clearly not the case we see in the universe today.



*The Universe must  
be very close to the  
Critical Density*

## Component 171 – The Horizon Problem

### The Cosmic Microwave Background Radiation

The furthest thing in the past that astronomers can detect is the Cosmic Microwave Background Radiation. Based on its redshift, these photons have been travelling for 13.8 billion years, from a time when the universe was 378,000 years old. This radiation, representing 2.7 K, is everywhere throughout the universe.

It was discovered in 1964 by Arno Penzias and Robert Wilson (see Figure 494). They were working for Bell Laboratories using a horn-shaped radio antenna (Figure 494) to study ground-based microwave transmissions when they found a “hiss” which they could not suppress. Ultimately they won the Nobel Prize in physics for discovering the faint glow of the Big Bang. This background was predicted in the 1940s.

Two satellites have been launched to study the CMBR in greater detail, without the interference of the Earth’s atmosphere: COBE (Figure 495) and WMAP (Figure 496).

This noise was present in all directions, day and night, and was almost uniform in frequency. Subtracting out the data from the Milky Way Galaxy (the horizontal brightness in the center of the images), the temperature range in the WMAP image is +/- 200 microKelvin.

Figure 428: CMBR by Penzias and Wilson (1965)

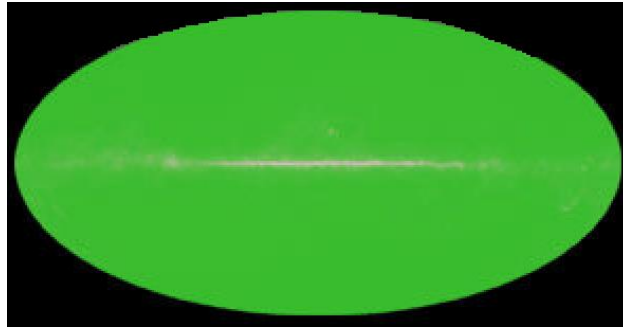


Figure 429: CMBR by COBE (1992)

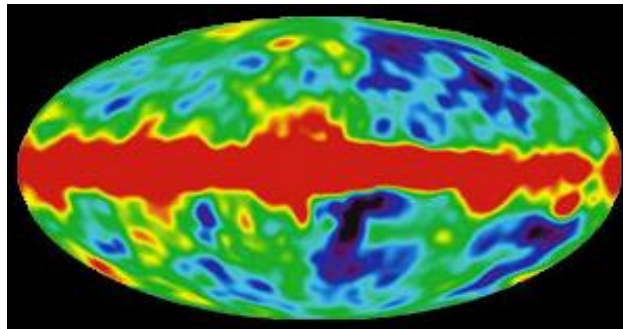
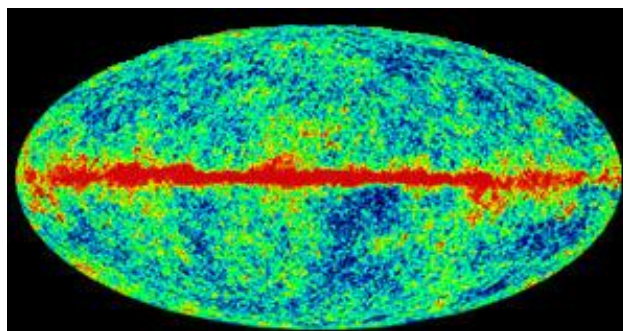


Figure 430: CMBR by WMAP (2003)



These photons would have been gamma rays when they were first created, and due to the expansion of the universe, they have been redshifted all the way to radio waves today.

### **Evidence for the Big Bang**

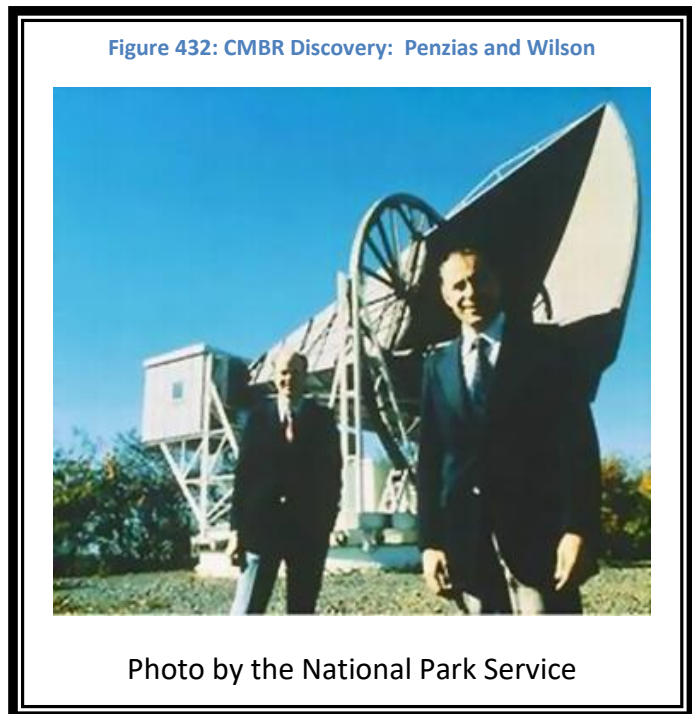
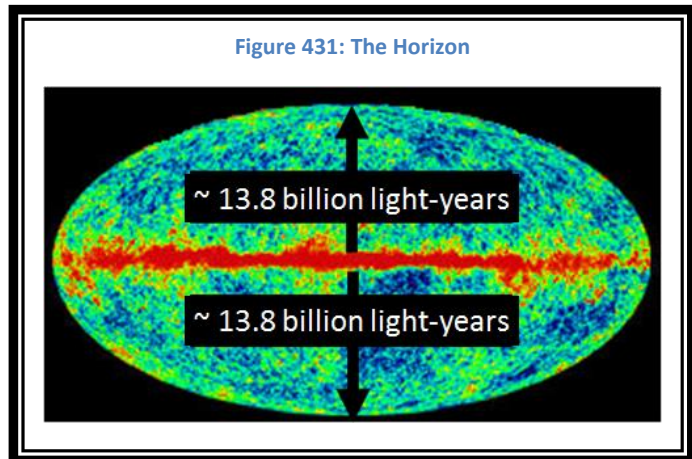
The fact that this radiation has been detected in all directions, is so uniform, and the fact that it was predicted, is strong evidence that the scientific theories of the Big Bang are good theories. This radiation is homogeneous and isotropic.

### **Presenting the Horizon Problem**

When astronomers see the Cosmic Microwave Background Radiation, they see it in one direction and also in the opposite direction. Since this radiation represents the universe as it was almost 13.8 billion years ago, we are seeing a total distance of 27.6 billion light-years (Figure 497).

The Horizon Problem arises because we see two parts of the universe that are 27.6 billion light-years apart. The universe is only 13.8 billion years old. Since the Cosmic Microwave Background Radiation is so uniform, those two points must have been close enough to share electromagnetic radiation. The cosmic speed limit is the speed of light and nothing can travel faster than the speed of light, so this is a paradox. How can they have shared information yet be so far apart? Something must have occurred in the past to allow these distant points in space to interact. The solution is the scientific theory of Inflation.

*The CMBR  
is uniform*





## Component 172 – Inflation

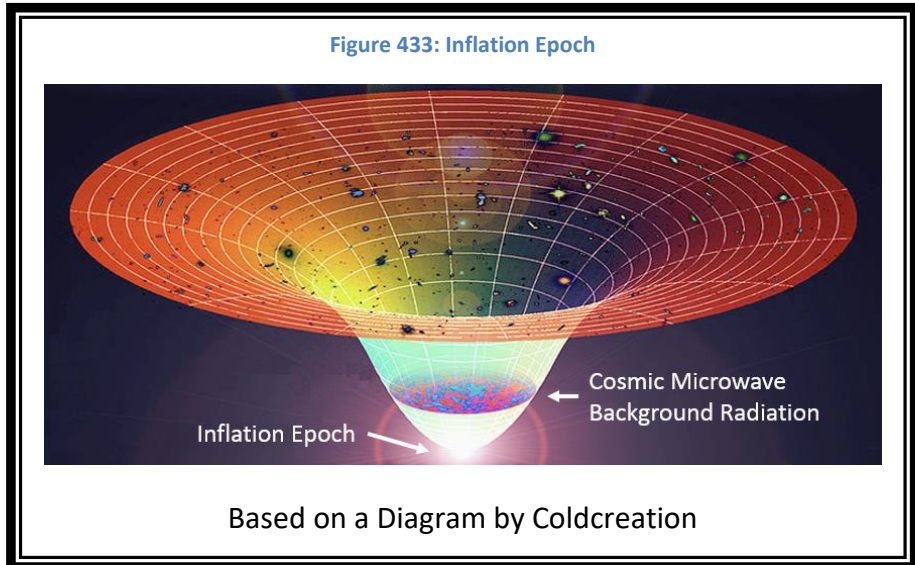
To enable communications by distant parts of the universe, the universe must have been considerably smaller in the past. To make this possible, it must have expanded significantly in a very short period of time. The **Inflation** would have occurred during a time in the early universe called the Grand Unified Theory Epoch (the **GUT Epoch**) (see Component 173), between  $10^{-36}$  and  $10^{-32}$  seconds after the Big Bang. In this short period of time, the universe would have expanded to a size  $10^{50}$  larger.

This expansion resulted in parts of the universe that were in sharing information with each other now being too far apart to share. This inflation resolves the Horizon Problem.

Inflation also resolved the Flatness Problem. A universe that might

have shown curvature was inflated  $10^{50}$  times. At this new scale, the curvature would have been expanded to the point where locally it would appear to be flat.

Any imperfections in the universe prior to inflation would have been magnified in the universe after inflation. These imperfections are evident in the slight variation found in the Cosmic Microwave Background Radiation.



*The Universe expanded by a factor of  $10^{50}$  in the Inflation Epoch from  $10^{-36}$  to  $10^{-32}$  seconds after the Big Bang*

## Component 173 – Stages of Evolution of the Universe

As the universe expanded and cooled the conditions changed and different activities were able to take place. Initially, the universe was densely packed with very high energy. Although this made it possible to create particles and atoms, it also made it possible for very high energy particles to destroy other particles and atoms. The conditions had to be within very tight limits to create and maintain matter.

The life of the universe can be broken up into three major eras: The Radiation Era, The Matter Era, and the Dark Energy Era. Each of these eras can then be broken into smaller epochs (pronounced similar to “epics”). Each epoch marks a place in the expansion of the universe where space expanded and the average temperature dropped.

Table 43: Evolution of the Universe

Era – Epoch	Start (seconds)	End (seconds)	Activity
Big Bang	0	0	Beginning of Space, Time, Matter, and Energy.
<b>Radiation Era</b>	0	$1.6 * 10^{12}$	Radiation Density Dominates.
<b>Planck Epoch</b>	0	$10^{-43}$	Gravity decouples with the other forces.
<b>GUT Epoch</b>	$10^{-43}$	$10^{-35}$	The Strong Force decouples with the other forces. This may also be the end of creation of particles we now consider Dark Matter.
<b>Quark Epoch</b>	$10^{-35}$	$10^{-4}$	Quarks, Protons, and Neutrons were created.
Weak Force	$10^{-10}$	$10^{-10}$	The Weak Force decouples with the Electromagnetic Force.
<b>Lepton Epoch</b>	$10^{-4}$	100	Electrons, muons, and neutrinos were created.
<b>Nuclear Epoch</b>	100	$1.6 * 10^{12}$	Protons and neutrons fused together to make nuclei.
Deuterium	120	300	Deuterium – finally able to form and survive.
<b>Matter Era</b>	$1.6 * 10^{12}$	$4.4 * 10^{17}$ (Today)	Matter Density Dominates.
<b>Atomic Epoch</b>	$1.6 * 10^{12}$	$6.3 * 10^{15}$	Helium formed.
<b>Galactic Epoch</b>	$6.3 * 10^{15}$	$9.5 * 10^{16}$	Galaxies are being formed from the primordial dust and gas as the first stars are forming.
<b>Stellar Epoch</b>	$9.5 * 10^{16}$	$4.4 * 10^{17}$	Star forming is the predominant activity in the universe. Galaxies are merging.
<b>Dark Energy Era</b>	$4.4 * 10^{17}$ (Today)		Dark Energy Dominates and the expansion of the universe accelerates.
Stellar Epoch continues	$4.4 * 10^{17}$ (Today)		Star forming continues.

## Component 174 – The Planck Epoch

The Planck Epoch stretches from the Big Bang (at time 0) to a time  $10^{-43}$  seconds after the Big Bang. (That is 1/10,000,000,000,000,000,000,000,000,000,000,000,000 of a second.)

During this epoch, all four fundamental forces of physics were united and behaved as one: Gravity, the Strong Force, the Weak Force, and the Electromagnetic Force. At the end of this epoch is when Gravity decoupled with the other three forces.

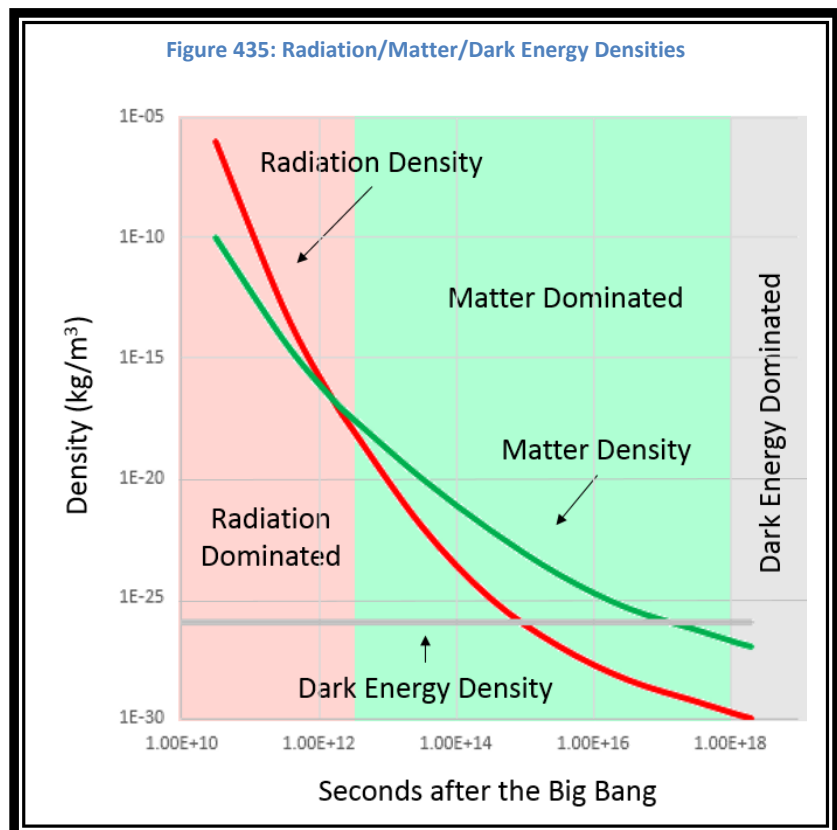
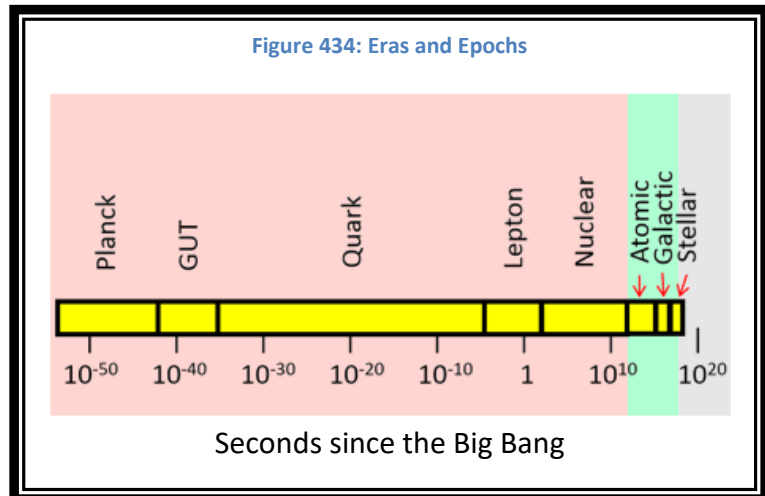
In physics today, we have no theories that apply to the universe in this early state. This theory, which is a major objective of theorists, is called the Theory of Quantum Gravity.

At the end of the Planck Epoch, the temperature of the universe would have been higher than  $10^{28}$  K. At this time Gravity decouples with the

other forces.

Figure 500 shows the timeline for the various epochs is the evolution of the universe.

Figure 501 shows the same timeline and the relationship of the Radiation, Matter, and Dark Energy Dominated Eras.



## Component 175 – The Grand Unified Theory Epoch

Astronomers have developed a scientific theory that describes the universe at a time when the Strong Nuclear Force, the Weak Nuclear Force and the Electromagnetic Force were still combined. It is known as the Grand Unified Theory, or GUT for short. The epoch of the universe's evolution that corresponds to this time period is called the GUT Epoch.

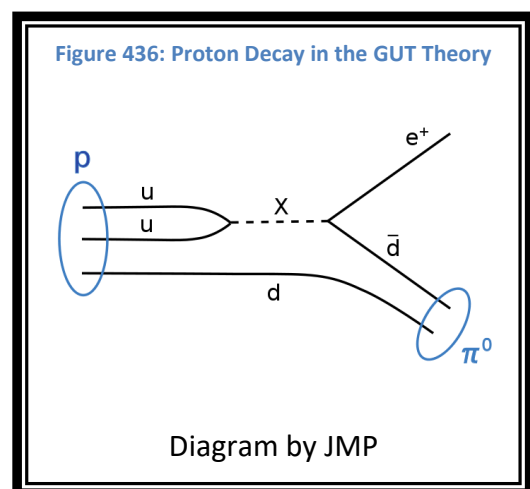
The GUT Epoch follows the Planck Epoch and represents the universe from  $10^{-43}$  to  $10^{-35}$  seconds after the Big Bang. Gravity has decoupled from the other three forces. At the end of the GUT Epoch, the Strong Force decouples from the Weak Nuclear Force and the Electromagnetic Force.

It was during this epoch that the universe underwent Inflation, growing in size by a factor of  $10^{50}$ . (See Component 172) After this period of rapid Inflation, the universe returned to its prior rate of expansion. During this epoch, the temperature of the universe would have been greater than  $10^{28}$  K.

To test the GUT theories, it is necessary to create the situation where the energy present is equivalent to the energy available at the end of the GUT Epoch. It is believed that the new Large Hadron Collider at CERN is powerful enough to recreate this environment.

It is possible that at the end of the GUT Epoch, many heavy and as yet unseen particles that only minimally interact with normal matter, may have been created. These particles are prime candidates for the missing Dark Matter.

One prediction from the GUT Theory is that Protons will decay. This has not been observed. Figure 502 show the diagram that explains how this would occur. A proton, composed of two up quarks and one down quark decays using an x boson into a positron, and a neutral pion, composed of a down quark and an anti-down quark. If this were to be observed, it would provide support for the GUT Theories.



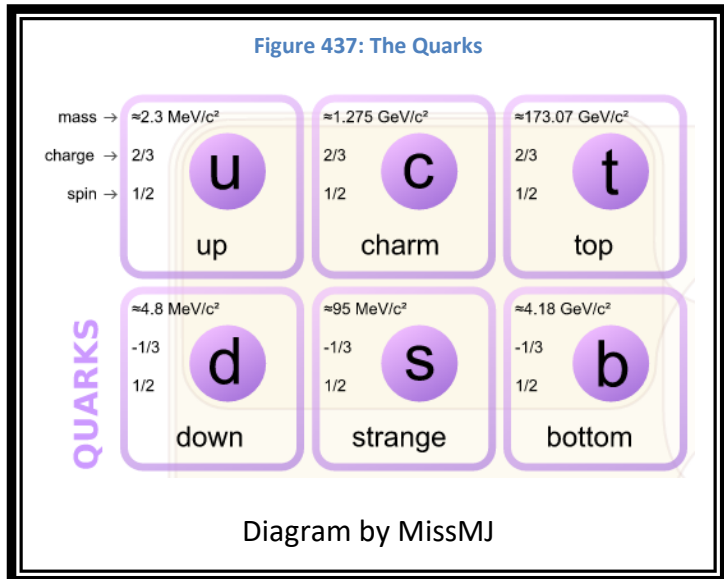
## Component 176 – The Quark Epoch

At the end of the GUT Epoch, the Electromagnetic Force and the Weak Nuclear Force are still coupled. Scientists refer to this as the Electroweak Theory. When the temperature of the universe dropped to  $10^{15}$  K conditions were right for the production of Protons, Neutrons, and the Quarks of which they are made. At this point, the Weak Nuclear Force and the Electromagnetic Force decouple and we now have the four fundamental forces of physics that we see today.

The Quark Epoch occurred between  $10^{-35}$  and  $10^{-4}$  seconds after the Big Bang. During this epoch the energy levels were still high enough to have photons with enough energy to create protons and neutrons through the process of pair production. By the end of this epoch, the energy has dropped to the point where these heavier particles can no longer be created.

The standard theory states that there are 6 quarks, and each has its anti-quark. They are called the Up, Down, Top, Bottom, Strange, and Charm Quarks. Figure 503 shows these quarks and some of their properties. Protons are composed of two Up Quarks and one Down Quark. Neutrons are composed of two Down Quarks and one Up Quark.

During the Quark Epoch, the Weak Force decouples with the Electromagnetic Force.



## **Component 177 – The Lepton Epoch**

At the end of the Quark Epoch, the universe moved into the Lepton Epoch. Leptons are the small, lightweight particles. Since they are lighter, it is possible to create them with lower energy photons. Leptons are electrons, muons, and neutrinos.

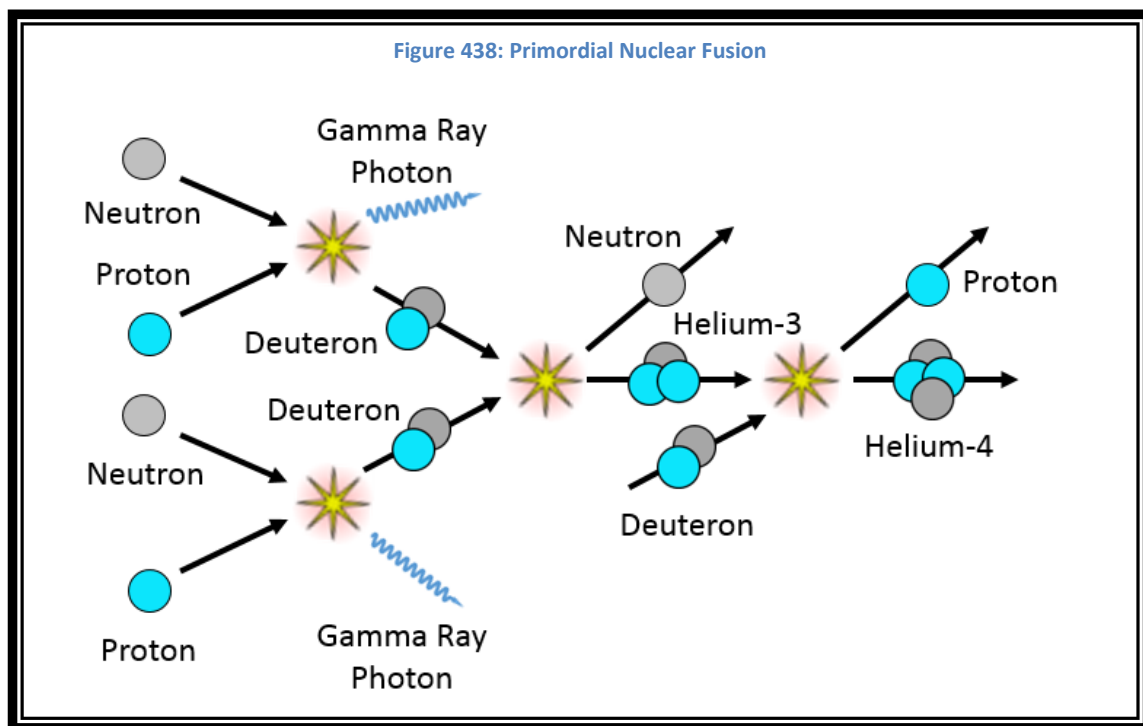
The Lepton Epoch occurred from  $10^{-4}$  to 100 seconds after the Big Bang. At about 1 second after the Big Bang, the universe has cooled sufficiently,  $3 * 10^{10}$  K, and the universe becomes transparent to neutrinos. At 100 seconds after the Big Bang the Lepton Epoch ends. The temperature would be about  $10^9$  K. At this temperature, the photons no longer have sufficient energy to continue pair production of the leptons.

## Component 178 – The Nuclear Epoch

The last epoch of the Radiation Era is called the Nuclear Epoch. It occurred from 100 to  $1.6 \times 10^{12}$  seconds after the Big Bang. The building blocks of atoms have been created. The universe has cooled sufficiently that as atoms begin to form they are not instantly blown apart by high energy particles. The temperature was still around  $3 \times 10^8$  K. The universe was dense enough, and this temperature is high enough, to cause nuclear fusion. Fusion would have progressed very quickly, and by the time the universe was about 15 minutes old, it would have expanded and cooled to the point where fusion would cease. Deuterium (heavy Hydrogen) and Helium would have been created in this short period of time, and the concentrations would be close to what we see today.

Fusion that occurred in the early universe was different than the fusion we see in stars today. Temperatures would have been higher and the available materials would have been different. Helium was created using protons and neutrons, rather than just protons as in the Proton-Proton Chain.

*Primordial Fusion used Protons and Neutrons to create Helium*



## Component 179 – The Atomic Epoch

At the end of the Radiation Dominated Era the abundance of Hydrogen, Deuterium, Helium, and Lithium was set. At this point, the abundance of dark matter was also set. It was at this time that radiation and matter decoupled. As the temperature of the universe dropped to approximately 3000 K, it was cool enough for electrons to combine with the primordial atoms. Prior to this point, the electrons were free in the universe and were constantly interacting with the photons. This means that photons were continuously interacting with the electrons and were not free to travel through space.

### Cosmic Microwave Background Radiation

With the cooler temperatures, and the electrons combining with the protons, the universe became largely transparent to photons. The Cosmic Microwave Background Radiation that we see today in the Radio Spectrum is the signature of those photons from the time when the universe became

transparent to them. The universe was a little less than 378,000 years old, and photons that were infrared were finally able to travel freely throughout the universe. As the universe expanded, these photons were redshifted into the top of the radio spectrum and are the Cosmic Microwave Background Radiation we see today.

*The CMBR we see today as Radio Waves was Infrared when the universe became transparent*

### Primordial Deuterium Abundance

If scientists are able to determine the density of deuterium in the universe, then they will be able to determine the density of matter in the universe and its relationship to the Critical Density. As deuterium is created in stars, it is immediately and completely consumed in the creation of helium. But in primordial dust clouds – those clouds not changed by the explosions of aging stars, and those clouds composed of hydrogen, helium, and deuterium from the Big Bang – the abundance of deuterium is unchanged from the Big Bang.

*The amount of Deuterium tells us the abundance of other atoms in the early universe – this tells us the density of matter in the universe*



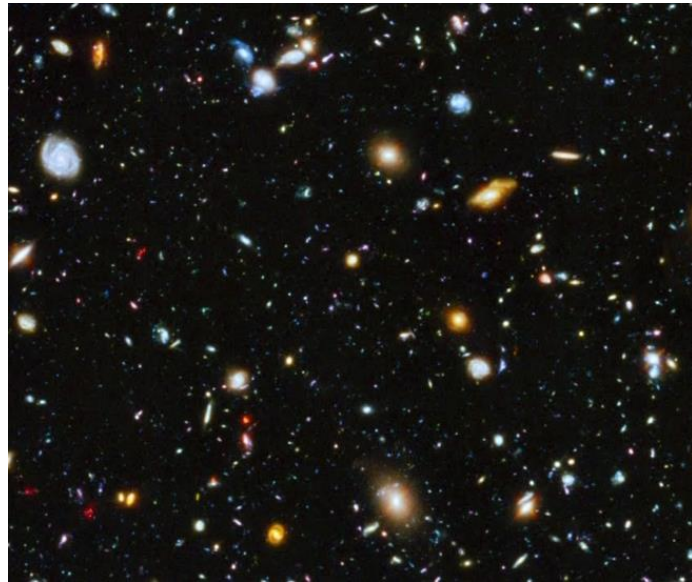
## Component 180 – The Galactic Epoch

As atoms became stable, they were able to collapse into stars, and in the young universe those stars clumped together into primitive galaxies. This was the start of the Galactic Epoch, it is approximately 200 million years after the Big Bang.

There is a question that astronomers have not resolved, and that is, did the galaxies come first and then the supermassive black holes? Or did the black holes come first? One possibility is that the supermassive black holes formed as a result of massive galaxies of stars forming first. It is likely that supermassive black holes, and the radiation emitted in jets from their accretion disks, would likely have a negative effect in the early formation of the galaxies, and it seems reasonable that the black holes would form as myriads of stars migrate to the center of the fledgling galaxies. Bottom line? It is likely that they formed together.

Every speck of light in Figure 505: The Hubble Ultra Deep Field image, is an early galaxy. The image reflects the universe when it was only approximately 4 billion years old. These would not have been the galaxies as they first appeared, but would be representative of the galaxies as they appeared at the end of the Galactic Epoch: the end of new galaxy formation.

Figure 439: The Hubble Ultra Deep Field



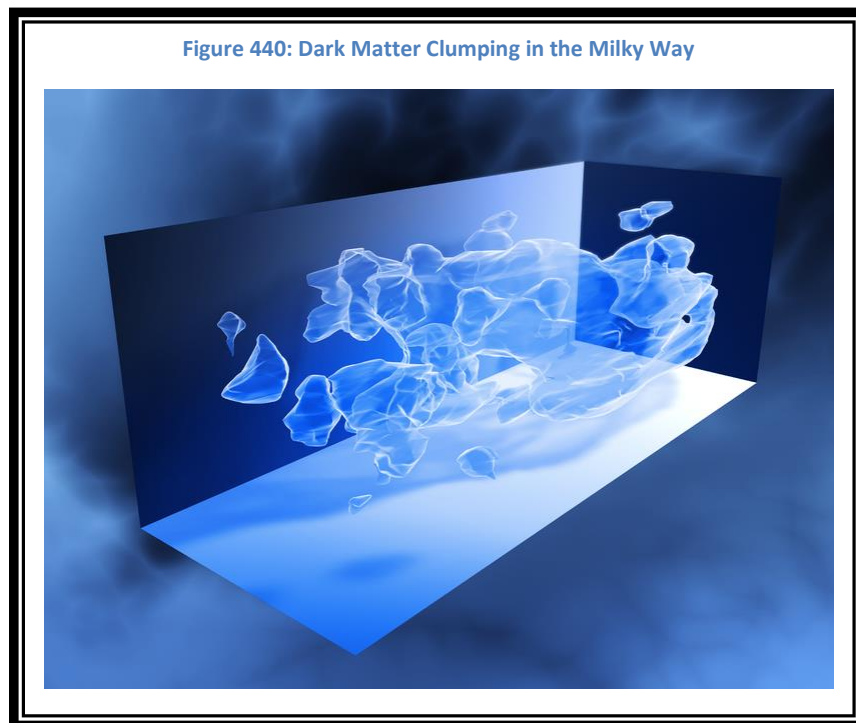
## **Component 181 – The Stellar Epoch**

By 3 billion years after the Big Bang galaxies had stopped forming from the primordial dust and gas. Stars continued to form in the existing galaxies, and we entered the Stellar Epoch. This is the epoch that we are in today. Galaxies continue to evolve through mergers, but the creation of galaxies from dust has ceased. This epoch also continues through the threshold from the Matter Dominated Era into the Dark Energy Dominated Era.

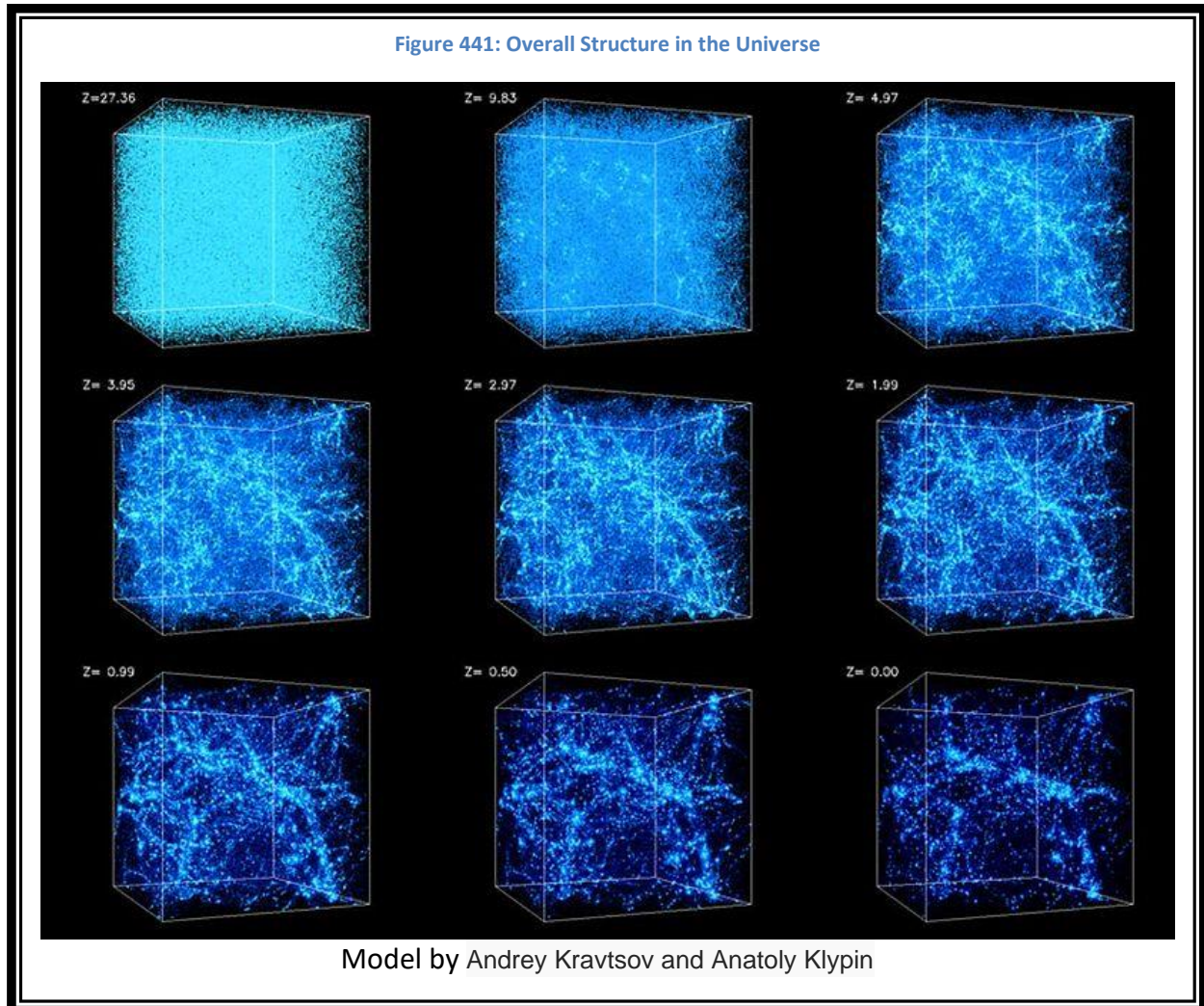
## Component 182 – Dark Matter and Structure

Current theories about the Big Bang imply that **Dark Matter** condensed out early. At this time, energy levels were too high for the stable creation of normal matter. But Dark Matter, since it does not interact much with normal matter, was able to survive. This dark matter then would clump and form structures before the normal matter could. These clumps of Dark Matter were focal points for the formation of structures of normal matter. This enabled the normal matter to form into the **structures** we see today more quickly than they would have been able to do without the Dark Matter. In fact, without the Dark Matter's head-start, we would not now be able to see the galaxies and other structures that we see in the universe today.

This would also correlate with the dark matter concentrations that we detect in the neighborhood of galaxies and galaxy clusters. Figure 506 shows a map of Dark Matter as seen from Earth. As you move from left to right, you are moving further away from Earth, and therefore moving backwards in time. The map clearly shows that as time has progressed, the clumps have become more well defined. This image was developed based on data from the Hubble Space Telescope COSMOS survey. The data was determined from measurements of weak gravitational lensing.



The universe with its structures of filaments and voids evolved over time. Figure 507 shows how this structure would have evolved over time until we reach the present. The initial stars would have formed from the atoms in the primordial dust and gas cloud. As time progressed these stars formed galaxies, and these galaxies became part of the larger structure. The numbers associated with the “Z” values are the redshift that corresponds to the stage of evolution.



## Component 183 – What is Life?

This sounds like a deep philosophical question, but for astronomers that are interested in finding life beyond the Earth, it is an important question. If you can't define life, then you really can't define your search. There is no clear definition of what constitutes life.

### Is Something Alive?

There seems to be some general agreement that something is alive if it:

- **Reacts** to stimulus in its environment – If the environment changes, the organism will react to this change in some way.
- It **moves** – This could be movement in the sense that animals move, or it could be changing its orientation to take advantage of light or water as plants do.
- **Consumes** nutrients – Materials are absorbed and converted into energy or materials to promote growth and reproduction.
- It **grows** – This could be growth in size or growth by producing additional cells.
- Is able to **reproduce** – Those things that are alive must be able to create additional examples of themselves.
- **Evolves** – Mutations occur over time and those changes are incorporated to make the organism more successful.

### How Does Life Start?

If you start with the elements created in stars, and you now have living organisms, the question is how did you get there. Scientists do not have all the answers but they do have many pieces of the puzzle.

Elements can be combined into molecules, some rather complex. When carbon is included in the mix, organic molecules can be created. Life depends on very complex molecules, but even the very complex molecules (such as proteins and DNA, deoxyribonucleic acid) are composed of building blocks and based on **Carbon**. **DNA** is composed of **nucleotide bases**. **Proteins** are composed of **amino acids**. Are there ways to take common molecules that would have existed on the Earth and combine them to form these building blocks?

In 1952, Stanley Miller and Harold Urey designed the **Miller Urey** experiment to determine if amino acids could be formed in the laboratory. The experimental apparatus consisted of chemicals and conditions that were present in the early Earth's environment: chemicals, water, and energy.

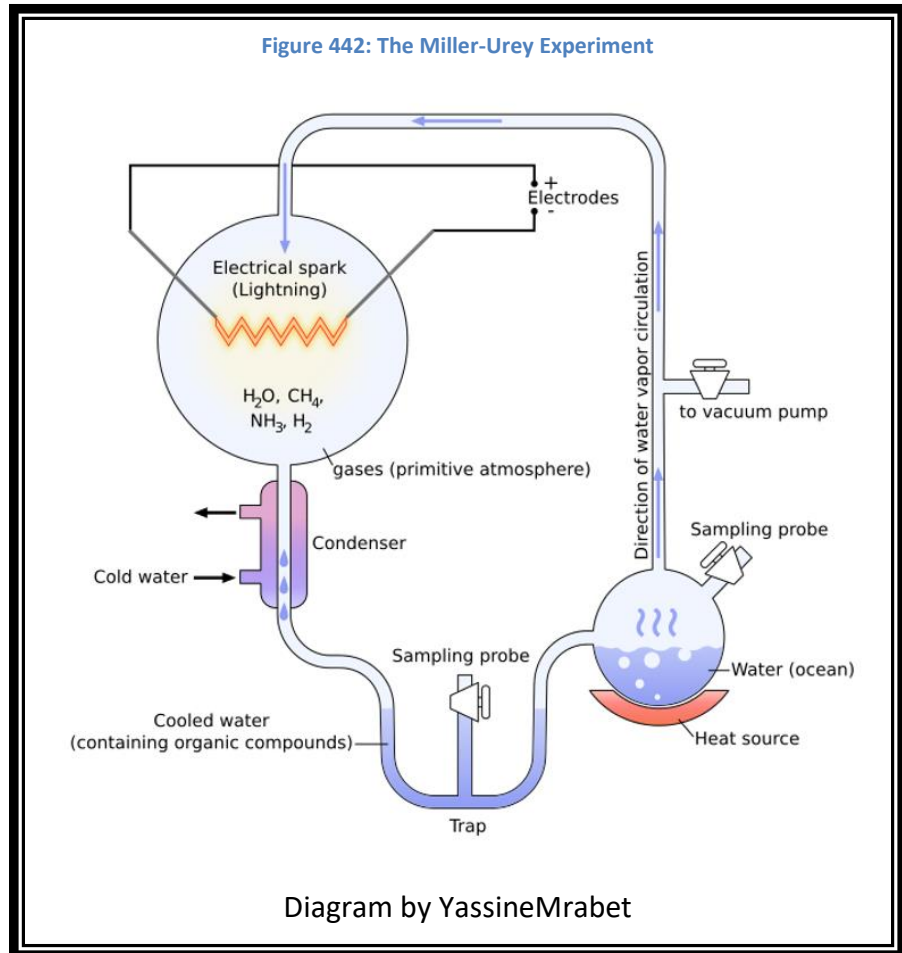
Water is heated until it boils. The water vapor moves to a chamber where there is a mixture of methane, ammonia, and hydrogen (components of an early atmosphere on Earth). Energy is applied to this mixture in the form of an electrical spark, not unlike lightning. The gases are cooled and are collected in a trap. When the material in the trap was analyzed, it was found that some amino acids had formed.

Initially, these starter ingredients would combine to form new

molecules: hydrogen cyanide, formaldehyde, acetylene, cyanoacetylene, and more. These molecules would then combine to form more complex molecules such as: amino acids and sugars. This simple experiment, designed to mimic conditions on the early Earth, was able to produce building blocks needed to create life.

### **Are Viruses Alive?**

But are there any links between complex organic molecules that are not alive and organisms that are alive? The answer is: "Yes!" Viruses are an example that would fill the missing link. Viruses do not always satisfy the conditions of being alive. If isolated in the laboratory, they do not seem alive. But when they are brought into contact with living organisms, they join with the cells of those organisms, and begin to behave as if they are alive. By themselves, the viruses do not have all of the tools to reproduce; but in a living cell, they are able to hijack the tools in the cell to make more viruses.



## Component 184 – What do You Need for Life?

Once we have an understanding of what life is, then we need to try to identify what environmental considerations are necessary for life to evolve.

### Components to Create Life

The **Source Materials**, atoms and molecules necessary to create life

abound in nature. The atoms and some molecules are created in stars, and in the proper conditions they combine to form more complex molecules.

The second consideration is a source of **energy**. The surface of a planet receives sunlight and the energy associated with it. Lightning in the atmosphere would also provide the needed energy. Additional energy would have been available from volcanic eruptions and asteroid impacts with the planet.

The third consideration is the **medium**. To enable chemical reactions to take place, the initial molecules and atoms need to be able to come into contact with each other. The easiest way for this to occur is if those materials are suspended in a liquid. On Earth, the most common liquid is water.

And the fourth consideration is a force to cause **agitation**. In the case of the Earth, ocean tides are caused by the gravity of the Sun and the Moon. In areas close to shore, tides would have caused much agitation in the water and provided the environment where more complex molecules could form.

### But, Not Only on the Surface

Although the surface of the Earth and its shallow ocean areas are well suited for life to evolve and thrive, there are other locations where the needs can be met. Figure 509 shows an example of a hydrothermal vent on the floor of the ocean, well away from lightning and sunlight. There is energy and nutrients for life to thrive.

### *To Create Life, You Need:*

- *Source Materials*
- *An Energy Source*
- *A Medium*
- *Agitation*

Figure 443: Oceanic Hydrothermal Vents

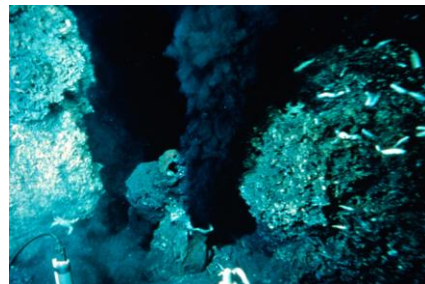


Photo by the US Geological Survey

## Component 185 – Sources for the Building Blocks

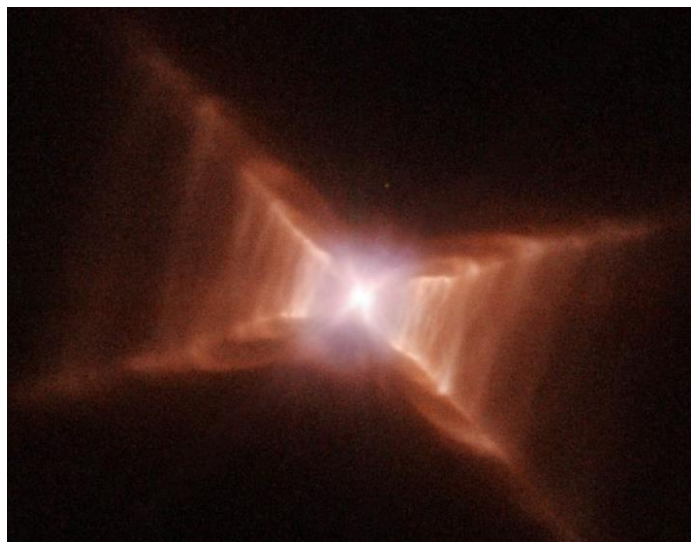
We have been able to produce some of the Building Blocks necessary for life in our laboratories, and the raw materials and appropriate environment existed on Earth to make complex molecules, the Building Blocks of life. But there are those who do not believe that there has been enough time for all of the pieces to have been made here on Earth. Do they exist in space? Could they be formed in space?

By studying the spectra of **nebulae** in space we are able to identify constituents in those dust clouds. In addition to many elements and molecules, some of the more complex molecules have also been identified in those clouds. These are some of the significant events in the search for Building Blocks of life in space:

- The first molecule was identified in 1937. It was the Methylidyne Radical (CH). Since then many more organic molecules have been found.
- In 2004, astronomers identified polycyclic aromatic hydrocarbons (PAHs) in nebulae. These are vital components in the formation of the complex molecules needed for life. Molecules such as anthracene and pyrene were found in the Red Rectangle Nebula (Figure 510).
- In 2012 astronomers identified the signature of glycolaldehyde. This is a sugar used to form ribonucleic acid.
- In 2015, NASA scientists created the building blocks of DNA and RNA in the laboratory including uracil, cytosine and thymine.

The identification of these molecules in dust clouds means that they do not have to form on planets but may arrive on planets during the process of planets forming from the stellar cloud. The process of creating life could have been jump-started by dust from space.

Figure 444: The Red Rectangle Nebula



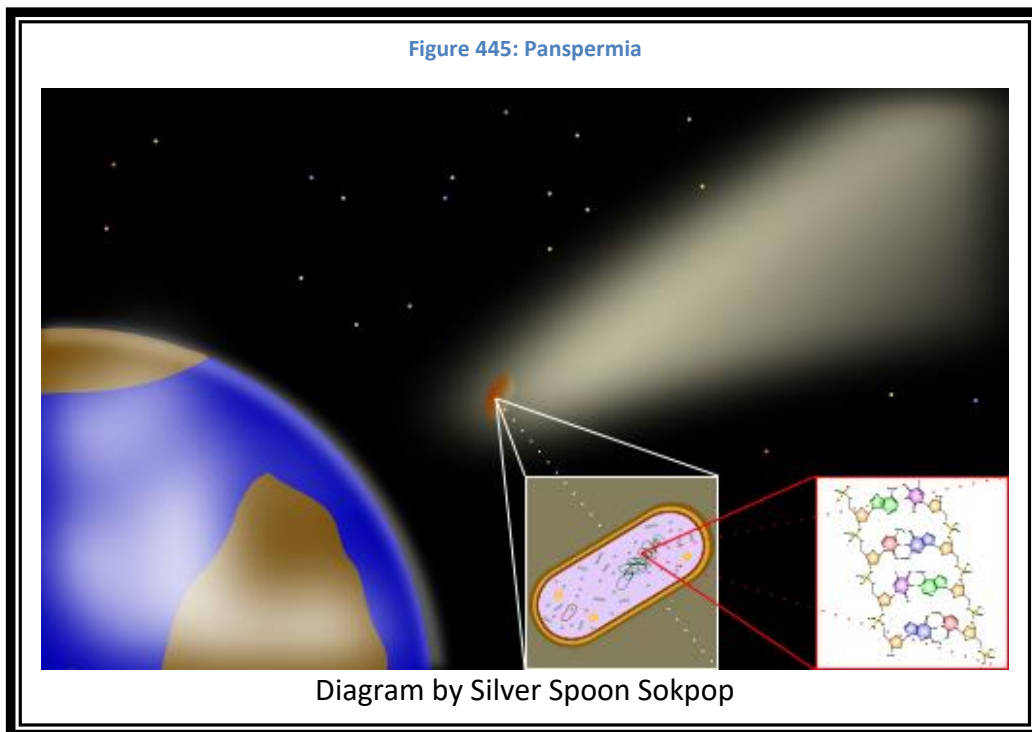


## Component 186 – Origins in Space

Although we have all the ingredients and a suitable environment on Earth for life to evolve and thrive, did it? There is no way to be sure, but there are theories. The most significant one is called Panspermia. It is the notion that life could have originated elsewhere in the solar system or elsewhere in the galaxy and been transported to the Earth as stowaways on **comets** and asteroids. A fifth century Greek philosopher, Anaxagoras, was first to propose the idea. In the 1800s and the 1900s some scientists began to consider the theory. In 2009, even Stephen Hawking acknowledged that this is a real possibility.

The life that would be transported in this way would be simple organisms, one-celled life similar to bacteria and viruses. We have life on Earth that lives in very hostile environments, which space certainly would be. They are called extremophiles. These are the organisms that live in boiling water in hot springs and under extremes of pressure and temperature by hydrothermal vents on the bottom of the ocean. Organisms have been found on Earth living below the Earth's surface in rocks.

Experiments have been done to test the survivability of different organisms in the different conditions that would be experienced as part of the process of **Panspermia**. No final conclusions have been reached, but there are cases where bacteria are able to survive the process.



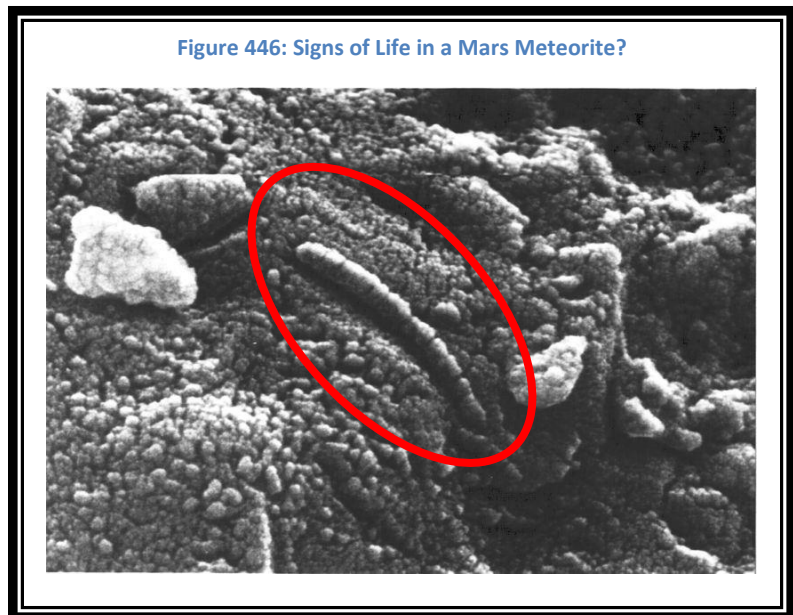
## Component 187 – Search for Life on Mars

When you consider the habitable region around the Sun, Venus, Earth, and **Mars** are the most likely candidates to have signs of life. In the case of Venus, the runaway greenhouse effect produces surface temperatures hot enough to melt lead, making it unlikely that any life survives. And the harsh conditions make it very difficult to search for signs of prior life. Mars, though, is more promising. Its temperature is more moderate; it has evidence for former flowing water as well as signs that much water is still there. So far, no life has been conclusively found.

Initially, NASA sent landers to Mars that were intended to identify if life, even in primitive forms, was present on the planet. In the 1970s NASA used Viking Landers to search for signatures of life: things that could only be there if life were there to make them happen. Soil samples were taken, baked in an oven, and the gases produced were analyzed to search for organic molecules. Although initially encouraging, other mechanisms were identified that resulted in the results being inconclusive.

Many landers and rovers have investigated the surface of Mars looking for evidence of water. These current efforts have proved conclusively that liquid water did flow on Mars in the past, and in 2015 evidence was found that liquid water is present in the material on Mars' surface.

NASA has also been studying meteorites that were found on Earth that have been shown to have originated on Mars. No conclusive evidence has been found in these samples as of this time. Initially, structures were found that resembled bacteria found on Earth; the alternative mechanisms were identified that could produce the same features. Figure 512 shows the feature found in Meteor ALH84001 by NASA.



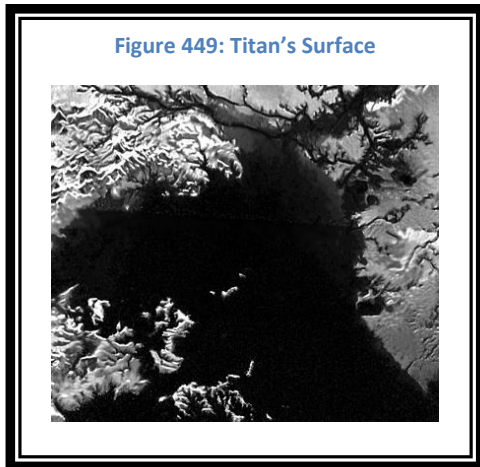
## Component 188 – Elsewhere in the Solar System

Although Mars seems to be a good place to look for life in our solar system, are there other places that could harbor life? Yes!

### Jupiter's Moons

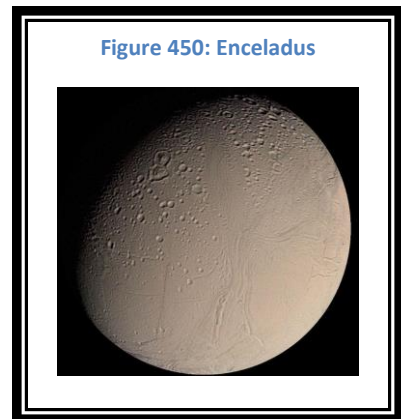
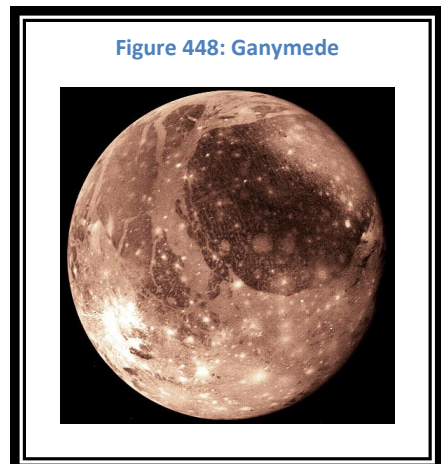
Two of Jupiter's large moons are believed to have large subsurface liquid saltwater oceans: **Europa** and **Ganymede**. Although they are well beyond the Sun's habitable zone, they may be in a habitable zone around Jupiter. Jupiter's gravitation force would cause flexing in the moons and this would produce heat and agitation needed to keep the water liquid and perhaps allow it to create and harbor life. Both moons show signs that their surfaces have been renewed by the upwelling of liquid water. There are far too few craters.

### Saturn's Moons



Two of Saturn's moons may also be candidates to find life. **Titan** and **Enceladus** may be viable candidates for harboring life. Although Titan is far too cold to satisfy the conditions of a habitable zone as previously described, it has an

abundance of organic materials and many lakes of liquid methane on its surface. Although this is not liquid water, it may be a suitable medium for chemicals to mix and form the complex molecules needed to form life. At the temperatures on Titan, chemical processes would take a very long time compared to the warmer temperatures on Earth, but billions of years may still be enough time for simple life to evolve. Hydrogen plumes have been found on Enceladus by the Cassini spacecraft. This indicates that materials needed for building life are available on the moon.



## Component 189 – The Drake Equation

There is an equation that was developed by **Frank Drake** in 1961. Drake was one of the pioneers in the Search for Extraterrestrials. The **Drake Equation** calculates the number of intelligent civilizations in a galaxy that are trying to communicate with us.

### Equation 26: The Drake Equation

$$N = N^* * fp * ne * fl * fi * fc * fL$$

N = The number of Intelligent Civilizations trying to communicate with us.

N\* = The number of stars in the galaxy.

fp = The fraction of stars that have planets orbiting them.

ne = The number of planets per star that are in the habitable zone.

fl = The fraction of those planets where life evolves.

fi = The fraction of planets with life that evolve intelligence.

fc = The fraction of intelligent life that want to communicate.

fL = The fraction of a planet's life during which there are communicating civilizations

To try this on the internet, go to the website:

<https://www.pbs.org/lifebeyondearth/listening/drake.html>

The only answer that is close to a “fact” is the number of stars in the galaxy. The other questions are opinions and are affected by your mood. So far we have found planets around many stars, but we have found life nowhere except on Earth. That one example of life is intelligent and is trying to communicate.

Have fun with the equation. Try changing some of your answers and notice the impact those changes have on the final outcome. I have seen results from 1 to 100,000,000.

Figure 451: Frank Drake

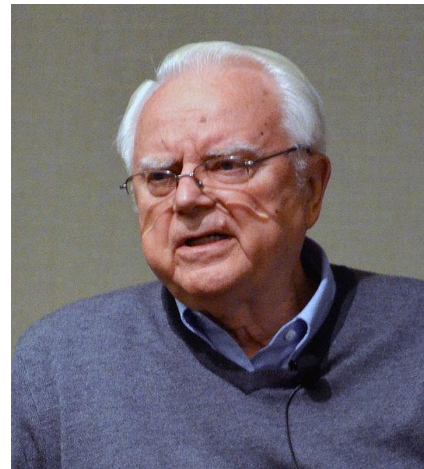


Photo by Raphael Perrino

## Component 190 – Search for Extraterrestrial Life

Are we alone? This is an ageless question, one that has haunted mankind for a long time. As we learn more about the universe – how large it is, how varied and yet how similar – the question continues. Is there life in the universe beyond the planet Earth. The name for the quest for those intelligent communicating civilizations is called **SETI**: The Search for ExtraTerrestrial Intelligence. The efforts were begun by Frank Drake and they have continued since.

The concept is to use **Radio Telescopes** to listen for radio waves arriving at Earth from outer space and to try to interpret a signal from within all the noise. The original work was done by Drake using the 85-foot diameter Greenbank Radio Telescope in 1960. It was called Project Ozma and was listening in the direction of Tau Ceti and Epsilon Eridani. No evidence was found after 150 hours of listening during a 4 month period.

Many additional searches have been conducted since that time, but no indications of intelligent communications from space have been identified. But, the search continues. In fact, so much data has been collected that the SETI Institute needs help in scanning it all for signals. There is an opportunity for members of the public to participate. It is called SETI@home. The website for more information is:

<http://setiathome.ssl.berkeley.edu/>

The concept is that there are many computers that are just sitting around idle at night. They developed a program that can run in the background of your computer, when you aren't using it, and it will search packets of radio data that have been received. Billions of packets have been scanned, but so far, no signals have been identified. In fact the person with the most packets analyzed has almost 1.7 billion packets.

In addition to listening we have communicated outward. **Gold Plaques** were mounted on the Pioneer Spacecraft that are rapidly exiting the solar system. We also provided information on the Voyager Spacecraft in the form of **Gold Records**. Now we wait to see if anyone finds them and responds. In fact, we have also sent strong radio signals out since 1936.

Figure 452: The Pioneer Plaques

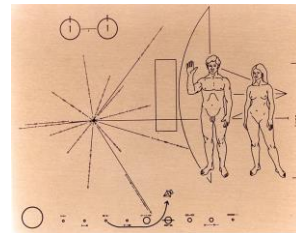
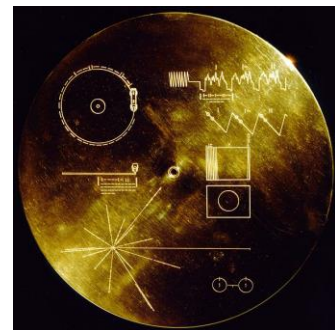


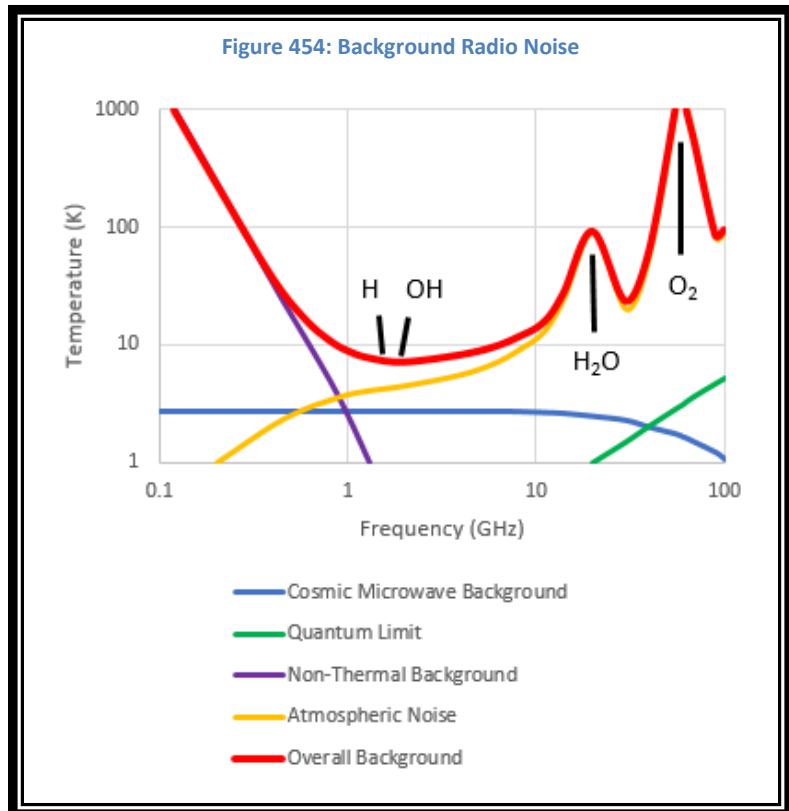
Figure 453: The Voyager Gold Record Cover



## Component 191 – What Frequency to Use to Search?

If we are going to search for communications from extraterrestrial intelligence, the question is which frequencies are the best options. If the messages are coming over great distances, then we need a frequency that will penetrate dust and gas easily. This pushes us to the Radio Frequencies. Then we need to consider sources of noise.

Figure 520 is a graph showing the various forms of radio noise that we receive on Earth. The blue line is the Cosmic Microwave Background Radiation. The purple line is the non-thermal background radiation, and the green line is the quantum limit. The orange line is the radio noise generated by the atmosphere. Note the peaks related to oxygen molecules and water molecules. The red line is the sum of all these sources of noise.



The goal is to use the quietest part of the radio spectrum. This would be the lowest parts of the red line. This portion of the red line contains the emission frequencies for the hydrogen atom (21-cm radiation) and the hydroxyl molecule (18-cm radiation). This has prompted the name for this regions as the **Water Hole**.

This reasoning makes sense to us humans, but may not be the same reasoning that extraterrestrials would use. Their atmosphere could be very different from ours, and if so, their minima may be in a different part of the radio spectrum. Many civilizations of extraterrestrials could be beaming communications towards us right now. Our challenge is to find the right frequency and the right direction in the sky to point our radio antennas.

## **Appendix 1: – Math for Mere Mortal Astronomers**

Astronomy is a science and yes, it is physics. All sciences and especially physics rely heavily on mathematics. But in introductory astronomy the math is at a reasonable level. But it is a bit more intensive than the stuff we learned in elementary school. This appendix is designed to give you the fundamental tools necessary to do the homework in Planetary and Stellar Astronomy. If you are a math wizard, then you don't need this appendix.

If you already understand the methodology of an item, then you can skip on to the next one.

### **Addition, Subtraction, Multiplication, and Division**

We are assuming that you are comfortable with these mathematical functions. If not, please talk with your instructor. With the plethora of low cost and well equipped calculators that are available, there is no need to do any of these functions long-hand in this class.

### **How Many Decimal Places?**

If you are using a calculator, then it will calculate as many decimal places as it has room for on the display. This is a wonderful feature, but it is excessive. You are plugging numbers into the calculator, or into an equation. Your result will be no more accurate than the numbers you start with. So if you are asked "What is the size of the floor in the room you are in now?" If you don't measure, you might say it is 15 feet by 20 feet. Both of these numbers have two digits and no decimal places. Your answer to an equation using these numbers should have no decimal places either. If you were to measure and you find the room is 14.5 feet by 23 feet, then you have either one decimal place (the 5 to the right on the decimal in the first number) or zero decimal places. At most your answer should have one decimal place.

**Rounding.** If your calculator gives you more than that, then you need to round off the answer. Rounding is what it is called when you need to decide what the rightmost digit of our answer should be. So with 14.5 and 23 you use an equation and get a result of 1.875. This is too many decimal places. You only want one. So you start with the 1.8 and then we have to decide do we round up or down. Rounding up would give you 1.9. Rounding down would give you 1.8. You ignore all of the decimal places except the next one to the right. In this case, it is a 7. You ignore the 5, so you have 1.87. If the number in that extra decimal place is 5 or larger, then you round up. If it is 4 or less, then you round down. Since 7 is larger than 5, you round up in this case. The answer you should submit is 1.9.

**Rounding – You try it.**

- |                                 |       |
|---------------------------------|-------|
| 1. 1 decimal place for 1.3193?  | 1.3   |
| 2. 2 decimal places for 1.3193? | 1.32  |
| 3. 3 decimal places for 1.3193? | 1.319 |
| 4. 0 decimal places for 1.3193? | 1     |

**Decimal Places – You try it.** You can use your calculator...

- |                 |      |
|-----------------|------|
| 1. $1.3 * 1.7$  | 2.2  |
| 2. $1.13 * 2.1$ | 2.37 |

**Exponents**

Exponents and exponential notation are a bit more of a challenge, but once you have done a few, you should be ready for them.

**What is Exponential Notation?** Exponential Notation is just a way to make large numbers smaller so we don't have to write so many zeros on the right-hand or left-hand ends. An example would be, rather than writing 300,000 km/sec for the speed of light, you could write it as  $3 * 10^5$  km/sec. The 5 in this number is called an exponent.

**Getting an Exponent.** In our example, 300,000 is really "300,000.". Whether you see it or not, the decimal place is really there. The exponent is the number of places you move the decimal place to the right or to the left.

- If you move the decimal place to the left, then the exponent will be a positive number.
- If you move the decimal place to the right, then it will be a negative number.

For 300,000, you moved it 5 places to the left. So you write  $10^5$ . This really means  $10 * 10 * 10 * 10 * 10$  which is 100,000 so  $3 * 10^5$  is really  $3 * 100,000$ , or the original 300,000.

You normally move the decimal to either a convenient number to get the units you want, or you move it so that there is only one number to the left of the decimal place.

**Exponents – You try it.**

- |                       |                      |
|-----------------------|----------------------|
| 1. 186,000 mi/sec     | $1.86 * 10^5$ mi/sec |
| 2. 0.000314159        | $3.14159 * 10^{-4}$  |
| 3. 0.0000000000001234 | $1.234 * 10^{-13}$   |



Now for an example of specific units

4. 0.000000001234 meters. You want the answer to be in nanometers. You know that there are  $10^9$  nanometers in a meter. So you want the answer to be an exponent of  $10^{-9}$ .  $0.1234 * 10^{-9}$  meters  
(Note the units are still meters because the exponent is there.)

### **Arithmetic with Exponents**

When you have  $8 * 2$  you just multiply the 8 by 2 and you get 16. Division works the same way. There will be times when you will have to do math with numbers that have exponents.

**Addition and Subtraction.** To add two numbers with exponents, they must have the same exponent. If they do not, then you move it and adjust the exponent to get a specific exponent (like item 4 above).

For example:  $3.1 * 10^2 + 3.1 * 10^4$ . You need to change the  $10^2$  to  $10^4$ . This is a change of +2 so the decimal place will move to the left.  $3.1 * 10^2$  becomes  $0.031 * 10^4$ . You now have the equation:  $0.031 * 10^4 + 3.1 * 10^4$ . Now with the exponents the same you can just add the numbers and use this exponent. The answer is:  $3.131 * 10^4$ .

Subtraction works similarly.

**Multiplication and Division.** To multiply two numbers with exponents is actually simpler. You multiply the two numbers and then add the exponents.

For example:  $(3.1 * 10^2) * (3.1 * 10^4)$ . First multiply  $3.1 * 3.1$ . This is equal to 9.61 which you will round to 9.6. Then you add the exponents  $4 + 2$ , which is 6. The answer is:  $9.61 * 10^6$ .

Division is the same except the exponent below the line is subtracted from the exponent above the line.

For example:  $(9.3 * 10^4) / (3.1 * 10^2)$ . First divide  $9.3 / 3.1$ . This is equal to 3.0. Then you subtract the bottom exponent from the top one:  $4 - 2$ , which is 2. The answer is:  $3.0 * 10^2$ .

**Exponent Math – You try it.** (Note the negative exponents.)

- |                                      |                |
|--------------------------------------|----------------|
| 1. $(1.37 * 10^5) * (2.1 * 10^3)$    | $2.88 * 10^8$  |
| 2. $(1.37 * 10^5) * (2.1 * 10^{-3})$ | $2.88 * 10^2$  |
| 3. $(1.37 * 10^5) / (2.1 * 10^3)$    | $0.652 * 10^2$ |
| 4. $(1.37 * 10^5) / (2.1 * 10^{-3})$ | $0.652 * 10^8$ |

## Rearranging Equations

Sometimes the equation is not the exact one you need. If you are trying to calculate a velocity, you want the “v” on the left side of the equal sign, and all by itself:  $v = d / t$ . If it is not there, then you need to rearrange the equation. Follow these rules.

**Moving Numbers.** If there is a number on the wrong side of an equation, use the opposite mathematical function to move it. Just be sure to do it to both sides of the equal sign.

For example, if we want to calculate “a” and we know “b” in this equation:  $a + 6 = b - 4$ , then we need to move the 6. Since it is “+ 6”, the opposite function is “- 6”. Our new equation becomes:  $a + 6 - 6 = b - 4 - 6$ . We know that  $+ 6 - 6 = 0$ . Also,  $- 4 - 6 = - 10$ . The resulting equation is:  $a = b - 10$ .

**Moving Numbers – You try it.** (Solve for “a” in all of these equations.)

- |                     |             |
|---------------------|-------------|
| 1. $a + 6 = b + 12$ | $a = b + 6$ |
| 2. $a + 12 = b + 6$ | $a = b - 6$ |
| 3. $a - 3 = b + 4$  | $a = b + 7$ |
| 4. $a - 3 = b - 4$  | $a = b - 1$ |
| 5. $b + 2 = a - 7$  | $a = b + 9$ |

**Reducing Multiples.** If you have a situation like “5 \* a” you need to get rid of the “5” to get to just “a”. Again, you just use the opposite function.

For example, if you want to calculate “a” and you know “b” in this equation:  $5 * a = 20 * b$ , then we need to move the 5. Since this is multiplication, we use division. Our new equation becomes:  $5 * a / 5 = 20 * b / 5$ . Since in multiplication and division the order of these functions is not important, we can rewrite the equation as:  $a * 5 / 5 = b * 20 / 5$ . We know that  $5 / 5 = 1$  so the left side becomes  $a * 1$  or just “a”. The right side becomes  $b * 4$ , so the final equation becomes:  $a = 4 * b$ .

Division works similarly, except rather than using division to reduce our numbers, you have to use the opposite: multiplication.

For example, if you want to calculate “a” and you know “b” in this equation:  $a / 4 = 20 * b$ , then we need to move the 4. Since this is division, we use multiplication. Our new equation becomes:  $a / 4 * 4 = 20 * b * 4$  or  $a * 4 / 4 = b * 4 * 20$ . We know that  $4 / 4 = 1$  so the left side becomes  $a / 1$  or just “a”. The right side becomes  $b * 80$ . The result is:  $a = 80 * b$ .

**Reducing Multiples – You try it.** (Solve for “a” in all of these equations.)

1.  $6 * a = 3 * b$

$a = 0.5 * b$

2.  $5 * a = b$

$a = b / 5$

3.  $a / 3 = 6 * b$

$a = 18 * b$

4.  $a / 4 = b / 2$

$a = 2 * b$

Sometimes you may have to do more than one operation to get “a” all by itself on the left.

### **Rearranging Variables**

You can do the same type of operation with variables that are on the wrong side of the equation.

For example, if you have the equation  $v = d / t$ , and we know the velocity and time, we need to do some rearranging. We need to solve for distance (d). Simply multiply both sides of the equation by time (t) and you get:  $v * t = d * t / t$ .  $t / t = 1$ , so you get:  $v * t = d * 1$  or:  $v * t = d$ .

### **Solving Equations**

**Get the Right Equation.** The first challenge in solving a problem, is finding the right equation to do what you want to do. Appendix 2 has the useful equations for introductory astronomy. Find the one that seems to do what you need to do with the variables that you have available.

**Substituting Numbers for Variables.** An equation is just a math problem where some of the numbers have been replaced with letters (variables). If you have numbers for all of the variables except one, then you can solve the math for the one that is missing.

For example: Using the equation for Velocity, we know that  $v = d / t$ . If we know d (distance travelled) and t (the time it took) then we can solve the equation by replacing the variables (the letters) with their values. If  $d = 100$  miles, and  $t = 2$  hours, then the equation becomes:  $v = 100$  miles / 2 hours, or 50 miles/hour.

When you have complex equations and someone didn’t put in a bunch of parentheses, how do you know what to do first? These are the rules of priorities in mathematics:

1. Parentheses: Do anything inside parentheses first.
2. Exponents, such as  $3^3$  which is really  $3 * 3 * 3$ , are done next. We get 27.
3. Multiplication and Division are done next.
4. Addition and Subtraction are done last.

## Astronomy for Mere Mortals – An Introductory Astronomy Text

When you move a number from one side of the equation to the other side, it operates on all of the pieces on both sides of the equation.

Let's try a complex equation. (We added the parentheses to make it easier to read.)

$$(3 * a) + (2 * b) + 12 = (60 * c) - (2 * d)$$

If we know b, c, and d, then we want to solve for a.

$$(3 * a) + (2 * b) + 12 - 12 = (60 * c) - (2 * d) - 12 \quad \text{Subtract 12, both sides.}$$

$$(3 * a) + (2 * b) = (60 * c) - (2 * d) - 12 \quad \text{Do a little math.}$$

$$\frac{(3*a)+(2*b)}{3} = \frac{(60*c)-(2*d)-12}{3} \quad \text{Divide both sides by 3.}$$

$$(3 * a)/3 + (2 * b)/3 = (60 * c)/3 - (2 * d)/3 - 12/3 \quad \text{Break it into pieces.}$$

$$a + (2/3 * b) = (60/3 * c) - (2/3 * d) - 4 \quad \text{Do a little math.}$$

$$a + \left(\frac{2}{3} * b\right) - \left(\frac{2}{3} * b\right) = (20 * c) - \left(\frac{2}{3} * d\right) - \left(\frac{2}{3} * b\right) - 4 \quad \text{Subtract the "b" piece.}$$

$$a = (20 * c) - \left(\frac{2}{3} * d\right) - \left(\frac{2}{3} * b\right) - 4 \quad \text{Do a little math.}$$

$$a = (20 * c) - (0.66 * d) - (0.66 * b) - 4 \quad \text{Change fractions to decimals.}$$

Then you plug in the values you have for b, c, and d, and do the arithmetic.

**Mixed Bag – You try it.** (Solve for "a".)

$$\text{Start with this equation: } (2 * a) + (3 * b) - \left(\frac{c}{4}\right) + 11 = (d * 4) - (e * 6)$$

Solve for a.

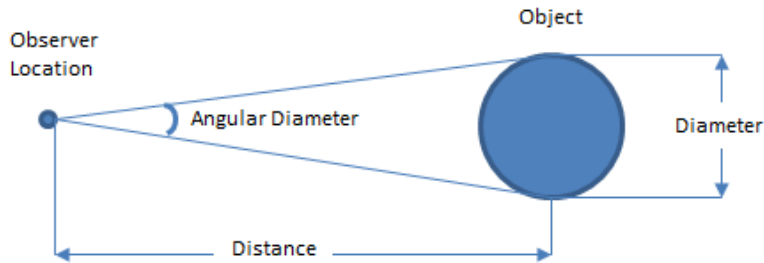
$$\text{Your answer should be: } a = (d * 2) - (e * 3) - 5.5 - (1.5 * b) + \left(\frac{c}{8}\right)$$

We will do only one of these since they are a lot of work. But if you got the same answer then you are ready for just about anything the astronomy courses will ask you to do.

## Appendix 2 – Useful Astronomy Equations

Be sure that you are comparing Apples to Apples! Do this before you start doing any math and be sure that the units match. For example, if you use Meters for one factor in an equation, do not use kilometers or miles in another part. Apply your conversion factors first.

### Triangulation / Parallax



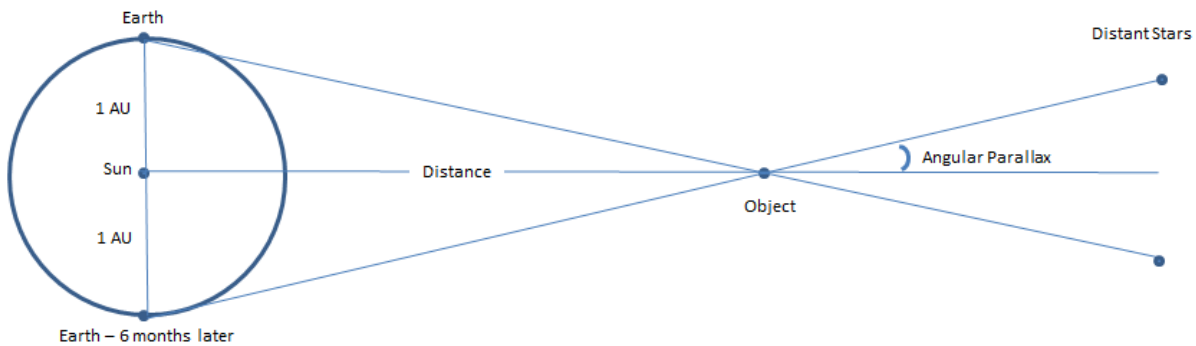
1. Calculating Distance when the Diameter of an object is known:

$$Distance = \frac{Diameter * 57.3}{Angular Diameter}$$

Note: \* is the symbol for multiplication.

2. Calculating the Diameter of an object when its Distance is known:

$$Diameter = \frac{Distance * (Angular Diameter)}{57.3}$$



3. Calculating Distance to an object using Parallax:

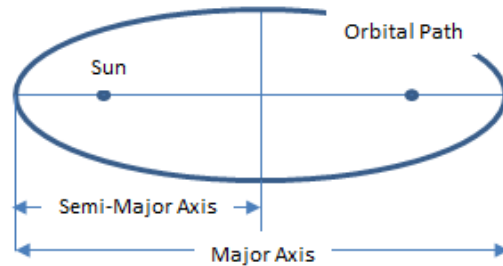
Baseline is the distance between the two observations.

Angular Parallax is half the angle between the two locations of the object.

$$Distance = \frac{\left(\frac{Baseline}{2}\right)}{\text{tangent}(Angular Parallax)}$$

**Note:** Many calculators and spreadsheets do Tangent calculations in radians not degrees. The conversion factor is:  $Radians = \frac{Degrees * 2 * 3.14159}{360}$

**Kepler's and Newton's Laws**



- 4. Kepler's 3<sup>rd</sup> Law – Calculating The semi-Major Axis based on the Orbital Period

$$(Semi-Major Axis) = ((Orbital Period in Earth Years)^{2/3})$$

Note: Note that the Period is squared and then taken to the power 1/3.

- 5. Calculating the Gravitational Force:

$$f = \frac{G * m_1 * m_s}{r^2}$$

m<sub>1</sub> is the mass of one object.

m<sub>2</sub> is the mass of the second object.

G is the gravitational constant: **6.67 \* 10<sup>-11</sup> Newton Meter<sup>2</sup> / Kilogram<sup>2</sup>**

- 6. Calculating the Mass of an Object Based on the Distance and Orbital Period of its Satellite:

$$M = \frac{r * v^2}{G}$$

M is the mass of the main body

r is the average distance to the satellite

v is the average orbital velocity of the satellite

To calculate v:

$$v = \frac{2 * 3.14159 * r}{P}$$

P is the orbital period of the satellite

- 7. Calculating the Orbital Velocity:

$$v_o = \left(\frac{G * M}{r}\right)^{\frac{1}{2}}$$

- 8. Calculating the Escape Velocity:

$$v_e = \left(\frac{2 * G * M}{r}\right)^{\frac{1}{2}}$$

**Spectra**

- 9. Calculating Frequency (v) from Period:

$$v = \frac{1}{P}$$

10. Calculating Period from Frequency:

$$P = \frac{1}{Fv}$$

11. Calculating Wavelength ( $\lambda$ ) from Frequency:

$$\lambda = \frac{C}{v}$$

C is the speed of light: 186,000 mi/sec or 300,000 km/sec

12. Calculating Frequency from Wavelength:

$$v = \frac{C}{\lambda}$$

13. Converting from Fahrenheit to Celsius:

$$C = \frac{(F - 32) * 5}{9}$$

14. Converting from Celsius to Fahrenheit:

$$F = \frac{C * 9}{5} + 32$$

15. Wien's Law: Calculating Temperature from Wavelength:

$$T(\text{Kelvin}) = \frac{2.9(\text{mm})}{\lambda}$$

16. Wien's Law: Calculating Wavelength from Temperature:

$$\lambda = \frac{2.9(\text{mm})}{T(\text{Kelvin})}$$

17. Stefan's Law: Calculate Energy Flux for an Object:

$$Fl = \sigma * T^4$$

Fl is the Energy Flux

T is the temperature in degrees Kelvin

$\sigma$  is the constant sigma:  $5.67 * 10^{-8}$  in Watts /meters<sup>2</sup> \* Kelvin<sup>4</sup>

18. Calculating the Recession Velocity based on the Doppler Effect:

$$V_r = \lambda_d * C / \lambda$$

$V_r$  is the recession velocity (velocity moving away)

$\lambda_d$  is the change in wavelength observed (actual wavelength – apparent wavelength)

$\lambda$  is the actual wavelength (the expected wavelength, the real thing...)

C is the speed of light

## **Photons**

19. Calculating the Energy of a Photon Based on its Frequency ( $v$ ):

$$E = h * v$$

$h = \text{Planck's constant} = 6.63 * 10^{-34}$  in Joule \* seconds

20. Calculating the Wavelength ( $\lambda$ ) of a Photon Emitted from a State Change of an Electron in a Hydrogen Atom (The Rydberg Formula):

$$\lambda = \frac{1}{R * \left( \frac{1}{n_2^2} - \frac{1}{n_1^2} \right)}$$

R is the Rydberg Constant:  $1.097373156852873 * 10^7$  in meters  $^{-1}$

$n_2$  is the lower or final state of the electron

$n_1$  is the higher or original state of the electron

### Telescopes and Binoculars

21. Calculating the Focal Ratio of a Telescope:

$$F = \frac{FL_T}{D}$$

F is the focal ratio for the telescope

$FL_T$  is the focal length of the telescope

D is the diameter of the telescope

22. Calculating the Magnification of a Telescope:

$$M = \frac{FL_T}{FL_E}$$

$FL_T$  is the focal length of the telescope

$FL_E$  is the focal length of the eyepiece

M is the resulting magnification

23. Calculating a Reflecting Telescope's Angular Resolution:

$$R = \frac{0.25 * \lambda}{D}$$

R is the angular resolution in arc-seconds

$\lambda$  is the wavelength of the light in micrometers

D is the diameter of the primary mirror in meters

24. Calculating a Telescope's Maximum Useful Magnification:

$$M_{max} = D * 2$$

$M_{max}$  is the maximum useful magnification

D is the diameter of the telescope in millimeters

25. Calculating a Telescope's minimum Useful Magnification:

$$M_{min} = D / D_{eye}$$

$M_{min}$  is the minimum useful magnification

D is the diameter of the telescope in millimeters



$D_{eye}$  is the diameter of the eye's pupil at night in millimeters (usually 5 mm)

26. Calculating a Telescope's Exit Pupil:

$$EP = \frac{FL_e}{F} = \frac{FL_e}{FL_t} * D$$

EP is the exit pupil

$FL_e$  is the focal length of the eyepiece

F is the focal ratio

$FL_t$  is the focal length of the telescope

D is the diameter of the telescope in millimeters

27. Calculating a Telescope's Actual Field of View:

$$FOV_a = FOV_{ap} / M$$

$FOV_a$  is the actual field of view – what you see in the telescope

$FOV_{ap}$  is the apparent field of view – provided by the telescope manufacturer

M is the magnification

## Planets

28. Calculating a Planet's Density:

$$D = \frac{M}{V} = \frac{M}{\frac{4}{3} * 3.14159 * r^3}$$

D is the density of the planet

M is the mass of the planet

V is the volume of the planet

r is the radius of the planet

## Radioactivity

29. Calculating the Amount of a Radioactive Material Remaining Based on Elapsed Time:

$$FR = \left(\frac{1}{2}\right)^{\frac{t}{T}}$$

FR is the fraction of the material remaining

t is the elapsed time

T is the half-life of the specific material you are measuring

## Roche Limits for Planets

30. Calculating the Roche Limit for a Planet:

$$RL = 2.4 * R$$

R is the radius of the planet

### Converting Mass and Energy

31. Converting Mass into Energy:

$$E = M * C^2$$

E is energy in Joules

M is mass in kilograms

C is the speed of light in kilometers per second

32. Converting Energy into Mass:

$$M = \frac{E}{C^2}$$

### Stellar Magnitudes

33. Calculating the Absolute Magnitude when the Apparent Magnitude and Distance are Known:

$$L = m - 5 * \text{Log}_{10} \left( \frac{D}{10 \text{ parsecs}} \right)$$

L is the luminosity

m is the apparent magnitude (the value we measure)

D is the distance in parsecs

34. Calculating the Distance when the Apparent and the Absolute Magnitudes are Known:

$$D = (10 \text{ parsecs}) * 10^{\frac{m-L}{5}}$$

35. Calculating a Star's Radius from its Luminosity and Temperature:

$$R = \left( \frac{L}{T^2} \right)^{\frac{1}{2}}$$

R is the radius

L is the luminosity

T is the temperature in degrees Kelvin

### Gravitational Deflection

36. Calculating the Deflection of a Star's Image because of the Sun's Gravity:

$$D = \frac{1.75 * M}{R}$$

D is the deflection of the star's image in arc-seconds

M is the mass of the Sun in kilograms

R is the radius of the Sun in kilometers

**Hubble's Law**

37. Calculating the Distance to a very Distant Object Using Hubble's Law:

$$D = \frac{V}{H_0}$$

D is the distance to the object

V is the recessional velocity as measured using the Doppler Shift

H<sub>0</sub> is the Hubble Constant: 70 km/sec/Mpc



## Appendix 3 – Pronunciation Guide

Many of the names used in astronomy are from foreign languages (Arabic, Greek, etc.). Unless you are a linguist, then they may indeed be foreign to you. This guide will help you pronounce them and sound like a pro!

This is the thorough list from A to Z of constellation names and star names, and how to pronounce them. Spellings of star names may vary from source to source.

### Star Names

Star Name	Constellation	Star Name Pronunciation
Acamar	Eridanus	AY-kuh-mar
Achernar	Eridanus	AY-ker-nar
Acrux	Crux	AY-kruhks
Adhara	Canis Major	ah-DAY-rah
Albireo	Cygnus	al-BEER-ee-oh
Aldebaran	Taurus	al-DEB-ah-ran
Alioth	Ursa Major	AL-ee-oth
Alkaid	Ursa Major	al-KADE
Al Nair	Grus	al-NAYR
Alnilam	Orion	al-NIGH-lam
Alphard	Hydra	AL-fard
Alphecca	Corona Borealis	al-FECK-ah
Alpheratz	Andromeda	al-FEE-rahts
Altair	Aquila	al-TAYR
Ankaa	Phoenix	AN-kuh
Antares	Scorpius	an-TAIR-eez
Arcturus	Bootes	ark-TOO-rus
Atria	Traingulum Australe	AT-ri-ah
Avoir	Carina	AY-vee-or
Bellatrix	Orion	BEL-a-trix
Betelgeuse	Orion	BET-el-jooz
Canopus	Carina	kah-NO-pus
Capella	Auriga	kah-PEL-ah
Deneb	Cygnus	DEN-eb
Denebola	Leo	de-NEB-oh-la

Astronomy for Mere Mortals – An Introductory Astronomy Text

<b>Star Name</b>	<b>Constellation</b>	<b>Star Name Pronunciation</b>
Diphda	Cetus	DIF-dah
Deubhe	Ursa Major	DUB-ee
Elnath	Taurus	EL-nath
Eltanin	Draco	el-TAY-nin
Enif	Pegasus	EEN-if
Fomalhaut	Piscis Austrinus	FO-mal-ought
Gacrux	Crux	GAY-kruX
Gienah	Corvus	JEE-nah
Hadar	Centauri	HAY-dar
Hamal	Aries	HAM-al
Kaus Australius	Sagittarius	KOSS aus-TRAY-lis
Kochab	Ursa Minor	KOE-kahb
Markab	Pegasus	MAR-kahb
Menkar	Cetus	MEN-kahr
Menkent	Centauri	MEN-kent
Miaplasidus	Carina	MY-a-PLAS-i-dus
Mirfak	Perseus	MEER-fak
Nunki	Sagittarius	NUN-kee
Peacock	Pavo	PEE-kok
Polaris	Ursa Minor	poe-LAHR-is
Pollux	Gemini	POL-lucks
Procyon	Canis Minor	PRO-see-on
Rasalhague	Ophiuchus	RAS-al-haig
Regulus	Leo	REG-you-lus
Rigel	Orion	RYE-jel
Rigel Kent	Centauri	RYE-jel KENT
Sabik	Ophiuchus	SAY-bik
Schedar	Cassiopeia	SHED-ahr
Shaula	Scorpius	SHAW-la
Sirius	Canis Major	SEER-ee-us
Spica	Virgo	SPY-kah
Suhail	Vela	soo-HALE
Vega	Lyra	VAY-gah
Zubenelgenube	Libra	zoo-BEN-al-je-NEW-bee

**Constellations**

<b>Constellation Name</b>	<b>Abbreviation</b>	<b>Constellation Name Pronunciation</b>
Andromeda	And	an-DROM-eh-duh
Antlia	Ant	ANT-lih-uh
Apus	Aps	AY-pus
Aquarius	Aqr	ack-KWAIR-ee-us
Aquila	Aql	ACK-will-ah
Ara	Ara	AY-ruh
Aries	Ari	AIR-eez
Auriga	Aur	or-EYE-gah
Bootes	Boo	boe-Oh-teez
Caelum	Cae	SEE-lum
Camelopardis	Cam	ka-MEL-oh-PAR-da-lis
Cancer	Can	KAN-surr
Canes Venatici	CVn	Kay-neeZ ven-AT-iss-see
Canis Major	CMa	Kay-nis MAY-ger
Canis Minor	CMi	Kay-nis MY-ner
Capricornus	Cap	kap-rih-KORN-nus
Carina	Car	ka-REEN-uh
Cassiopeia	Cas	kass-ee-oh-PEE-yah
Centaurus	Cen	sen-TAW-rus
Cepheus	Cep	SEE-fee-us
Cetus	Cet	SEE-tuss
Chamaeleon	Cha	ka-MEEL-eon
Circinus	Cir	SUR-sin-us
Columba	Col	ko-LUM_bah
Coma Berenices	Com	KO-mah bear-en-EYE-sees
Corona Australis	CrA	kor-OH-nah oss-TRAY-liss
Corona Borealis	CrB	kor-OH-nah bo-ree-ALICE
Corvus	Cor	CORE-vuss
Crater	Crt	KRAY-turr
Crux	Cru	KRUX
Cygnus	Cyg	SIG-nuss
Delphinus	Del	del-FINE-uss
Dorado	Dor	dough-RAH-dough

## Astronomy for Mere Mortals – An Introductory Astronomy Text

<b>Constellation Name</b>	<b>Abbreviation</b>	<b>Constellation Name Pronunciation</b>
Draco	Dra	DRAY-ko
Equuleus	Equ	ek-KWOO-lee-us
Eridanus	Eri	eh-RID-ah-nuss
Fornax	For	for-NAX
Gemini	Gem	JEM-in eye
Grus	Gru	GRUSS
Hercules	Her	HER-kyou-leez
Horologium	Hor	hor-o-LO-jee-um
Hydra	Hya	HIGH-druh
Hydrus	Hys	HIGH-drus
Indus	Ind	IN-duss
Lacerta	Lac	la-SIR-tah
Leo	Leo	LEE-oh
Leo Minor	Lmi	LEE-oh MY-ner
Lepus	Lep	LEE-puss
Libra	Lib	LEE-brah
Lupus	Lup	LEW-puss
Lynx	Lyn	LINKS
Lyra	Lyr	LYE-ruh
Mensa	Men	MEN-sah
Microscopium	Mic	my-kro-SKO-pee-um
Monoceros	Mon	mon-OSS-er-us
Musca	Mus	MUS-kah
Norma	Nor	NOR-mah
Octans	Oct	AHK-tahnz
Ophiuchus	Oph	off-ih-YOU-kuss
Orion	Ori	oh-RYE-un
Pavo	Pav	PAH-vo
Pegasus	Peg	PEG-uh-suss
Perseus	Per	PURR-see-us
Phoenix	Phe	FEE-nix
Pictor	Pic	PICK-torr
Pisces	Psc	PIE-sees
Piscis Austrinus	PsA	PIE-siss oss-TRY-nus
Puppis	Pup	PUPP-iss



Astronomy for Mere Mortals – An Introductory Astronomy Text

<b>Constellation Name</b>	<b>Abbreviation</b>	<b>Constellation Name Pronunciation</b>
Pyxis	Pyx	PICK-siss
Reticulum	Ret	ray-TIC-you-lum
Sagitta	Sag	sah-JIT-tah
Sagittarius	Sgr	saj-ih-TAY-rih-us
Scorpius	Sco	SKOR-pih-uss
Sculptor	Scl	SKULPT-tor
Scutum	Sct	SKYOU-tum
Serpens	Ser	SIR-pens
Sextans	Sex	SEX-tans
Taurus	Tau	TAW-russ
Telescopium	Tel	tell-ih-SKO-pee-um
Triangulum	Tri	try-ANGH-gu-lum
Triangulum Australe	TrA	try-ANGH-gu-lum oss-TRAY-lee
Tucana	Tuc	too-KAH-nah
Ursa Major	UMa	URR-sah MAY-jer
Ursa Minor	UMi	URR-sah MY-ner
Vela	Vel	VEE-lah
Virgo	Vir	VER-go
Volans	Vol	VO-lanz
Vulpecula	Vul	vul-PECK-you-lah



## Appendix 4 – Glossary of Terms

Like any science, astronomy has its own language. To be able to communicate with other astronomers, understand their communications, and understand the concepts in astronomy you need to understand the terminology.

Active Galactic Nuclei	The core of an Active Galaxy.
Granules	Small areas on the Sun's Surface (about the size of a continent on Earth). They are the tops of the solar convection cells.
Trojan Asteroids	Asteroids that are in the Lagrangian Points 60 degrees ahead or behind a major planet.
T-Tauri Star	A star with violent surface activity in the Protostar stage.
21-Centimeter Radiation	Radio waves that are emitted when an excited electron in an atom has spin in the same direction as the nucleus drops back to the ground state of antiparallel spin.
Absorption Lines	The specific frequencies of light that are absorbed by a cool non-dense gas when light passes through it that vary depending on what element or molecule is in the gas cloud.
Accretion	The act of bits of dust and gas gathering together to form larger bodies through gravitation.
Active Galaxy	A Galaxy whose core is very active and is emitting more radiation than normal due to the Black Hole consuming matter.
Active Optics	Controlling environmental and mechanical fluctuations to improve image quality. These include improved dome designs, airflow control, mirror temperature control, and mirror shape control.
Adaptive Optics	The manipulation of a mirror's shape to compensate for atmospheric changes in real time, employing a laser-generated star.
Altitude	Height above the horizon in degrees, minutes, and seconds. 0 degrees on the horizon. 90 degrees directly overhead (the Zenith).
Amor Asteroids	Asteroids that cross Mars' orbit but not Earth's.
Amplitude	The height of a wave's maximum above the center line.
Angular Resolution	The smallest angle between two objects that a telescope can split.

## Astronomy for Mere Mortals – An Introductory Astronomy Text

Aphrodite Terra	Aphrodite Terra – one of the large high altitude areas on Venus.
Apollo Asteroids	Asteroids that have orbits that cross Earth's orbit.
Associations	Very large Star Clusters.
Asteroid Belt	The region between Mars and Jupiter where most Asteroids orbit.
Asteroids	Large rocky objects. Not big enough to become round, but larger than meteoroids. Most reside in the Asteroid Belt between Mars and Jupiter.
Atmosphere	The gaseous layer above the Earth's Crust and Hydrosphere.
Atom	The smallest unit of a specific element such as Hydrogen or Iron.
Atomic Epoch	The first epoch of the Matter Dominated Universe, from 50,000 years to 200 million years after the big bang. The temperature has continued to drop to the point where electrons can combine with the atomic nuclei.
Aurora	The glow in the Atmosphere when charged particles spiral into the magnetic poles. The Northern Lights are really called Aurora Borealis. The Southern Lights are really called Aurora Australis.
Azimuth	Direction along the horizon of an object: 0 degrees is North, 90 degrees is East, 180 degrees is South, and 270 degrees is West.
Balmer Series	The photons emitted when an electron returns to the first excited state. Different electrons come from electrons at different initial excited states.
Barred Spiral Galaxies	Spiral Galaxies with a bar of stars crossing the center to which the Spiral Arms are connected.
Belts	The darker lines on the cloud tops of Jupiter. They are lower areas of downward circulation.
Big Bang	The term used to describe the start of the Universe; the start of all matter, energy, space, and time.
Binary Star Systems	When two or more stars form from the same nebula and are close enough that they orbit each other.
Black Dwarf	The theoretical endpoint of a stars life when the white dwarf has cooled to the background temperature in space. No stars in the Universe have reached this stage.
Black Hole	A very large star, at the end of its life. If it is greater than 3 solar masses is will overcome the Neutron Degeneracy Pressure and continue to collapse. Gravity is so strong that not even light can escape.

## Astronomy for Mere Mortals – An Introductory Astronomy Text

Blackbody Curve	The curve of the different frequencies of light emitted by an object. It is shaped like a hump.
Blue Shift	When an object is moving towards you, the lines in the light being emitted are moved in the blue direction (shorter wavelengths).
Brown Dwarf Stars	Objects that form that are too small to have complete Nuclear Fusion. They are dimmer and smaller than Red Dwarfs. They may have a short burst of Deuterium Fusion.
Callisto	Jupiter's outermost Galilean Moon. Unlike the other Galilean Moons, Callisto appears not to be Differentiated.
Caloris Basin	A large impact basin on Mercury.
Carbon Detonation Supernova	A White Dwarf companion in a Semi-Detached Binary Star system collects matter from its companion until it reaches 1.4 Solar Masses (the Chandrasekhar Limit). At this point the carbon in the White Dwarf spontaneously ignites in Carbon Fusion.
Cascade	An electron returning to its ground state in multiple steps.
Cassagrain Focus	The point where the image is in focus in a reflecting telescope after bouncing off the secondary mirror and exiting the tube through the primary mirror.
Cassagrain Telescope	A reflecting telescope utilizing the Cassegrain Focus.
Cassini Division	A gap of lower particle density between the A and B rings.
Catastrophic Theory	The scientific theory that addresses the irregularities and unusual situations found in the Solar System. For example Venus' rotation, the Moon, etc.
CCD	A Charged Coupled Device or digital camera used in astronomy.
Celestial Equator	The Earth's equator extended out into space.
Celestial North Pole	The point in the sky that would be directly over your head if you were standing at the Earth's North Pole.
Celestial South Pole	The point in the sky that would be directly over your head if you were standing at the Earth's South Pole.
Celsius	The temperature scale most commonly used in the rest of the world. Water freezes at 0 degrees and boils at 100 degrees.
Chromatic Aberration	A defect in refracting telescopes due to light of different colors focusing at different focal lengths after passing through the lenses.
Chromosphere	The layer in the Sun's Atmosphere above the Photosphere. This is the layer that can be seen in Hydrogen-Alpha solar telescopes.

Closed Universe	Space is curved enough that the Universe curves back and closes on itself. In two dimensions, think of the surface of a sphere. There is no edge and there is no center.
-----------------	--

## Astronomy for Mere Mortals – An Introductory Astronomy Text

Cloud Fragmentation	The breaking into smaller pieces of a nebula due to gravitational collapse, ultimately resulting in stars.
CNO Cycle	An alternative means of forming Helium that uses existing Carbon in the core of the star. This is more common in stars larger than the Sun.
Comet Coma	A gas and dust cloud around the Comet Nucleus.
Comet Nucleus	The central object in a comet.
Comet Tails	There are two tails. One is composed of ions, one is composed of dust. They always point away from the sun.
Comets	Icy bodies that have left their stable orbits beyond Neptune and travel in towards the sun.
Comparative Planetology	The study of the planets by comparing them to one another, especially comparing them to Earth.
Condensation Theory	The scientific theory that describes how planets could form from bits of matter in the Solar Nebula that stuck together or condensed. It is an add-on to the basic Nebular Theory.
Conjunction	The point when a superior planet is on the opposite side of the Sun from the Earth.
Contact Binary	A binary star system where both stars have expanded beyond their Roche Lobes and are sharing material with each other.
Continental Drift	The motion of large chunks of the Earth's Crust. Also known as Plate Tectonics.
Continuous Spectrum	The light emitted from a hot solid, liquid, or dense gas.
Convection	The boiling motion of the Earth's Atmosphere as warm air rises and cooler air drops.
Convection Zone	The region of the Sun's interior outside the Radiation Zone. The material in this region is churning like a pot of boiling water.
Core	<ul style="list-style-type: none"> <li>• The center of the Earth or any other differentiated object. Often it has an inner core and an outer core.</li> <li>• The center of the Sun or any other star.. The place where the fusion takes place.</li> </ul>
Corona	The outer solar Atmosphere. It is only visible during a Total Solar Eclipse.
Coronal Mass Ejections	Large amounts of solar material that is blown out into space.
Coronal Hole	Locations on the surface of the Sun where material can freely escape into space. They are most visible in Ultraviolet light and are the sources of Coronal Mass Ejections (CMEs).
Cosmic Microwave Background Radiation	Radio waves left over from soon after the Big Bang.
Cosmological Constant	The number that reflects the curvature of space and is a measure of whether the Universe is above or below the

## Astronomy for Mere Mortals – An Introductory Astronomy Text

	Critical Density of matter and energy.
Cosmological Principle	That the Universe is Homogeneous and Isotropic.
Cosmological Red Shift	The Red Shift due to the expansion of space.
Coude Focus	The point where the image is in focus in a reflecting telescope after bouncing off a tertiary mirror and exiting the tube near the bottom end.
Craters	Holes left by the impact of Meteors and Asteroids on the surface of a larger object.
Crest	The high point on the curve of a wave.
Critical Density	The exact amount of matter and energy required for the Universe to neither collapse in upon itself due to gravity, or to continue to expand forever.
Critical Universe	The Universe is flat, there is no curvature. It is infinite.
Crust	A thin layer that sits on top of the mantle and is hard solid materials.
Dark Energy	An unknown energy that is responsible for the expansion of the Universe.
Dark Energy Dominated	As the Universe continued to expand, Dark Energy began to dominate over matter (gravity) and the expansion of the Universe is accelerating.
Dark Energy Era	From the present to the future. This is the point where the effects of Dark Energy are dominating over matter.
Dark Matter	Matter in the outer regions of the Galaxy that we cannot see and do not know what it is. It is detectable by its affect through Gravity.
Dark Matter halo	A halo of Dark Matter outside of the Galactic Halo.
Dark Nebulae (singular is Nebula)	Regions of space where the dust and gas clouds are so dense that they block light from passing through.
Declination	Imaginary lines in the sky that form bands around the sky that is parallel to the celestial equator. They go from 0 degrees at the celestial equator to 90 degrees at the celestial poles.
Deimos	One of Mars' moons, probably a captured Asteroid.
Detached Binary	A binary star system where both stars are still within their Roche Lobes and are not sharing material with each other.
Deuterium Bottleneck	The delay in creating Helium due to the time required to make Deuterium in the early Universe.
Differential Rotations	The rotation of the atmosphere on a gaseous object (Jovian Planet or the Sun) that varies depending on latitude. Also known as Zonal Flow.
Differentiation	The separation of materials inside an object. The heaviest materials drop to the core.
Diffraction	The tendency of a light ray to spread out making it more difficult to get focus.
Diffraction Grating	An alternative to a prism that is used in some

## Astronomy for Mere Mortals – An Introductory Astronomy Text

	spectroscopes.
Doppler Effect	You can tell how fast an object is approaching you based on the shift of lines in the light it emits as it is moving.
Drake Equation	A mathematical equation designed to determine the number of planets that have intelligent species that are trying to communicate with others in a galaxy. There are a number of factors (almost all guesses) that are used to determine the number.
Dust Lanes	Regions of thick dust and gas that block the light from emission nebulae.
Dwarf Planets	Solar system bodies that orbit the Sun, are roughly spherical, but are not massive enough to clear their orbits of debris. Current Dwarf Planets are: Pluto, Ceres, Eris, Haumea, and Makemake.
Eccentricity	How elongated an ellipse is.
Eclipsing Binaries	Binary Stars that are not able to be split visually, but can be identified by observing their light curve as one star eclipses the other.
Ecliptic	The path of the Earth as it orbits the Sun. On Earth, the path the Sun seems to follow through the background stars.
Electromagnetic Force	The fundamental force governing electricity and magnetism. Photons are the transfer particle for the Electromagnetic Force.
Electromagnetic Radiation	Particles or waves of energy that transfer electrical and magnetic forces.
Electron Degeneracy Pressure	The pressure required to force hydrogen atoms close enough together for Helium Fusion to begin. This results in the Helium Flash.
Electrons	Small negatively charged particles that exist outside the nucleus of an atom.
Ellipse	An elongated circle. The path that all objects follow that are orbiting another object.
Elliptical Galaxies	Large balls of stars with no definite structure. They have from millions to trillions of stars.
Emission Lines	The light emitted from a hot non-dense gas in the forms of very specific lines of light that vary depending on what element or molecule is in the cloud of gas.
Emission Nebula	A gas cloud in space that emits light in the red because of excited electrons emitting the Balmer Series alpha line.
Emission Nebulae (singular is Nebula)	Clouds of dust and gas that glow pink from photons exciting electrons and then re-emitting them in a different direction.
Enke Gap	A gap of lower particle density in the outer A ring of Saturn.



## Astronomy for Mere Mortals – An Introductory Astronomy Text

Escape Velocity	The speed required by an object like a cannon ball that is needed to escape the Earth's (or another planet's) gravity.
Europa	Jupiter's second Galilean Moon. It may have a large liquid ocean under the icy crust.
Excited State	The state of an electron that has received additional energy by a collision with a photon.
Exoplanets	Planets that orbit other stars than the Sun.
Extinction	Dust or gas thick enough to stop light from distant stars reaching Earth.
Extrasolar Planets	Planets that orbit other stars than the Sun.
Extremophiles	Organisms that can live and evolve in environments that seem too harsh for life to exist.
Fahrenheit	The temperature scale most commonly used in the US. Water freezes at 32 degrees and boils at 212 degrees.
Filaments	Areas in the Universe where there seem to be strings of Galaxies between which there are Voids.
Flares	Short lived loops and sheets of material rising above the Sun. They may only last a few minutes.
Flatness Problem	If the Universe is curved, why does it appear to be so flat?
Fly-By	A mission for a spacecraft designed to fly past an object in space without landing or going into orbit around that object.
Focus (ellipse)	One of the two points inside an elliptical orbit that both objects actually orbit around (the Sun and the Earth, or the Earth and the Moon, etc.).
Focus (telescope)	The place in the light path in a telescope where the image is clear, due to curvature in the lenses and mirrors.
Forbidden Lines	These are spectral lines that appear in nebulae but are not visible in laboratories on Earth.
Frequency	The number of crests that pass by a point as the wave moves, per second.
Fusion	The combination of smaller building blocks to form heavier atoms.
Galactic Bulge	The central part of a Spiral Galaxy that bulges out from the Galactic Disk.
Galactic Disk	The flat part of a Spiral Galaxy where the arms are. This is where the Solar System is located in the Milky Way Galaxy.
Galactic Epoch	From 200 million years to 3 billion years after the Big Bang. This is the time when large scale structure of the Universe formed (galaxies and larger).
Galactic Halo	The sphere around a Galaxy.

## Astronomy for Mere Mortals – An Introductory Astronomy Text

Galaxy	A very large collection of stars, all gravitationally bound together and orbiting a central black hole (usually). There are from Millions to Trillions of stars.
Galaxy Cluster	A group of Galaxies that are gravitationally bound together.
Galaxy Evolution	The process by which a Galaxy evolves through mergers from a small irregular Galaxy, to one with a central Black Hole, then to a Quasar, then to a Radio Galaxy or a Seyfert Galaxy, and finally into the Elliptical and Spiral Galaxies we see today.
Galilean Moons	Jupiter's four large moons that are visible from Earth in a pair of binoculars: Io, Europa, Ganymede, and Callisto.
Gamma Ray Bursts	One of the most violent events in the Universe. Astronomers are not sure whether they are due to the merger of two Neutron Stars in a Binary Star system or if it is due to a stalled Supernova restarting.
Gamma Ray Observatory	An observatory designed to detect electromagnetic radiation in the gamma ray part of the spectrum. Note these instruments do not focus the gamma rays. They are not really a telescope.
Gamma Rays	The shortest wavelengths in the spectrum.
Ganymede	Jupiter's third Galilean Moon. Like Europa, it may have a large subsurface liquid ocean.
General Theory of Relativity	The scientific theory developed by Einstein that redefines the nature of gravity.
Geocentric	The theory that the Earth is the center of the Universe and that all objects orbit around the Earth.
Globular Clusters	Star Clusters that often have millions of stars. They are as old as the galaxy and look like snowballs of stars.
Gravitational Redshift	A redshift in light that is emitted in the vicinity of a large mass due to the curvature of space.
Gravity	The force of attraction between two objects.
Gravity	One of the fundamental forces. It affects everything. Gravitons are the transfer particle for the Gravitational Force.
Great Red Spot	This is a large hurricane-like storm that has been raging on Jupiter for over 300 years.
Greenhouse Effect	The ability of the atmosphere to act like a greenhouse and trap Infrared Radiation thereby smoothing out atmospheric temperature changes. This is responsible for nights being only a little bit cooler than days, but can also cause a dramatic increase in average surface temperature (see Venus).
Greenhouse Gases	Molecules in the Earth's Atmosphere that capture Infrared

Astronomy for Mere Mortals – An Introductory Astronomy Text

	Radiation causing the Greenhouse Effect. They include Carbon Dioxide and many complex hydrocarbons.
Ground State	The state that an electron is in normally as it exists outside of the nucleus of an atom.
Gravitational Lensing	The effect of light passing near a high mass and its path being curved.
GUT Epoch	The Grand Unified Theory Epoch, from $10^{-43}$ to $10^{-35}$ seconds after the Big Bang. Gravity has separated from the other three fundamental forces.
Habitable zone	The distance from a star where liquid water can exist. Also the distances from the Galactic Center where there are enough heavier elements and not too much radiation for life to exist.
Heliocentric	The theory that the Sun is the center of the solar system and that all of the planets orbit the Sun.
Helium Flash	The stage in the life of a star, after Hydrogen Fusion has waned. It is the point when a Sun-like star begins Helium Fusion. This does not occur in large stars.
Helium Precipitation	Droplets of helium that form in Saturn's atmosphere and drop to the lower atmosphere. This is responsible for Saturn emitting more radiation than it receives from the Sun.
Hellas Basin	A large depression in the surface of Mars caused by a large impact.
Hertz	The unit that frequencies are measured in.
Hierarchical Merging	Galaxies are formed by mergers of smaller objects into larger and larger objects.
Highlands	Highlands – higher areas on an object like the moon. They are older than the surfaces of the Maria.
Homogeneous	On very large scales, of a few hundred mega-parsecs, every chunk of the Universe is the same.
Horizon Problem	If the Universe is only 10 billion years old, and we can see 13.5 billion years in opposite directions, and everywhere we look the universe is homogeneous, how can this be? To be in thermal equilibrium, the Universe must have had time to communicate from one point to all other points. And this can only be done up to the Speed of Light.
Hot Jupiters	Planets the size of Jupiter or larger that orbit very close to their stars.
HR Diagram	A tool used to chart where a star is based on its Luminosity and temperature. Its full name is the Hertzsprung-Russell Diagram.
Hubble's Constant	A constant that defines the expansion of the Universe.
Hubble's Law	The Red Shift of a distant Galaxy is directly related to its distance.

## Astronomy for Mere Mortals – An Introductory Astronomy Text

Hydrogen Envelope	A large cloud of hydrogen surrounding the Comet Coma.
Hydrosphere	The layer of water covering much of the Earth's crust.
Hydrostatic Equilibrium	The balance between the inward pressure due to gravity and the outward pressure due to the nuclear Fusion.
Impact Theory	Impact Theory – the scientific theory that explains the origin of the Moon by a collision of a Mars-sized body with the Earth 4 billion years ago.
Inferior Conjunction	The point when an inferior planet is directly between the Sun and the Earth.
Inferior Planets	The planets whose orbits are with the Earth's orbit: Mercury and Venus.
Inflation	From $10^{-38}$ to $10^{-35}$ seconds after the Big Bang the Universe went through a rapid and immense expansion in size.
Infrared Light	The waves between radio waves and visible light.
Infrared Telescope	A telescope designed to detect electromagnetic radiation in the infrared part of the spectrum.
Interferometry	The use of multiple telescopes looking at the same object at the exact same time. This can be done with Radio, Infrared and Visual wavelengths. The resolution is determined by the baseline between the telescopes. The ability to see faint objects (light gathering ability) is determined by the actual surface area of the telescopes.
Interplanetary Matter	All of the stuff in the solar system that is not the Sun, planets, dwarf planets, or moons.
Interstellar Dust	Particles of dust in space that are rice shaped and as a result polarize the light that passes through them.
Interstellar Medium	The material (dust and gas) that exists in open space.
Ionosphere	The top layer of the Earth's Atmosphere where molecules and atoms are ionized by cosmic rays from the Sun and space.
Io	The innermost of Jupiter's Galilean Moons. It has active sulfur volcanos.
Irregular Galaxies	Misshapen Galaxies that do not fall into the other classifications.
Ishtar Terra	Ishtar Terra – one of the large high altitude areas on Venus.
Isotropic	The Universe is the same no matter which direction you look.
Jovian Planets	Those planets that are Jupiter-like; gas giants: Jupiter (Jove), Saturn, Uranus, and Neptune.
Kelvin	The temperature scale used in astronomy. It is the Celsius scale adjusted so that 0 degrees is the point where all motion stops. Water freezes at 273 degrees and boils at 373 degrees.

## Astronomy for Mere Mortals – An Introductory Astronomy Text

Kirkwood Gaps	Locations in the Asteroid Belt that are in synchronous orbits with Jupiter. They are places where Jupiter's gravity has caused the Asteroids to migrate to higher or lower orbits.
Kuiper Belt	The region beyond Neptune where icy bodies orbit the Sun. It is similar to the Asteroid Belt.
Lava Domes	Lava Domes – pancake shaped structures caused by lava welling up and then subsiding.
Lensing	An effect on light as it passes by massive objects (Black Holes, Galaxies, Galactic Clusters) resulting in multiple images of a distant Quasar. They often appear as streaks.
Lepton Epoch	From $10^{-4}$ to 102 seconds after the Big Bang. The Universe has continued to cool to the point where electrons are not destroyed by high-energy photons.
Leptons	Small particles like electrons, muons, and neutrinos.
Light Pollution	Man-made light reflecting off of dust in the atmosphere and bouncing back at the astronomer and the telescope. It makes it more difficult to differentiate an object from the background skies.
Local Bubble	The region in which the Sun is that has less gas and dust than average for space. This results in more Ultraviolet Light being able to reach Earth.
Luminosity	A star's absolute brightness as seen from 10 parsecs away.
Luminosity Class	From Roman Numeral I through V. Class V stars are on the Main Sequence. Class I is divided up into two groups Ia and Ib.
Lyman Alpha Forest	The series of Red Shifted Lyman Alpha lines apparent in the spectrum of a Quasar due to the light passing through multiple dust clouds on its way to the observer.
Lyman Series	The photons emitted when an electron returns to the ground state. Different photons come from electrons at different initial excited states.
Magnetosphere	The zone above the Earth's atmosphere where charged particles are captured.
Magnitude	The apparent brightness of a star as seen from Earth is called Apparent Magnitude. Absolute Magnitude is based on a standard scale and is the Apparent Magnitude as seen at 10 parsecs distance.
Main Belt Asteroid	Those Asteroids that orbit in the Asteroid Belt.
Main Sequence Turnoff	The stage of a star's life where it spends most of its life in a very stable state.
Main Sequence Turnoff	The point in the HR Diagram for a Globular Cluster where the stars have left the Main Sequence and are becoming

## Astronomy for Mere Mortals – An Introductory Astronomy Text

	Red Giants. It tells us the age of the Globular Cluster.
Mantle	A thick layer on Earth surrounding the cores.
Maria	Maria – (Mare is the singular form) large craters on the moon that have been filled by molten rock. They appear black when you look at the moon.
Matter Dominated	As the Universe expanded and cooled, matter could form and overtime the density of matter exceeded the density of energy.
Matter Era	The time during which matter has dominated the Universe. It includes these epochs: Atomic, Galactic, and Stellar, and brings us to the present time.
Mesosphere	The layer of the Earth's Atmosphere above the Stratosphere.
Meteor	The glowing trail of a Meteorite traversing the Earth's Atmosphere.
Meteor Shower	Multiple meteors that appear to originate in the same Radiant.
Meteor Storm	A heavy duty Meteor Shower.
Meteorite	A Meteor that has made it to the ground and appears as a rock.
Meteoroid	A small rocky body. Smaller than an Asteroid, and most are debris from comet tails.
Mid-Atlantic Ridge	A ridge formed in the middle of the Atlantic Ocean where material is coming up to fill a split between two separating plates and has formed a ridge.
Milky Way Galaxy	The Galaxy in which the Solar System resides.
Millisecond Pulsars	Pulsars that rotate so rapidly that they flash the Earth every few milliseconds. It is believed that they are the result of incoming material increasing the spin of the Neutron Star.
Molecular Clouds	Clouds of dust and gas that have a high concentration of molecules.
Molecular Rotation	A feature of molecules that emits radio waves when a rotation state returns to a lower energy state.
Molecular Vibration	A feature of molecules that emits infrared light when a vibration state returns to a lower energy state.
Molecules	A collection of two or more atoms that are chemically bound.
Moon	Any natural object orbiting another object (other than the Sun).
Nebular Theory	The scientific theory that describes how the Solar Nebula transformed into the planets of the Solar System
Neutron Capture	The activity of an atom absorbing a neutron from the environment and transforming into an atom with a higher atomic mass. There is a slow process and a rapid process.
Neutron Capture	The activity of an atom absorbing a neutron from the

## Astronomy for Mere Mortals – An Introductory Astronomy Text

	environment and transforming into a higher atom. There is a slow process and a rapid process.
Neutron Degeneracy Pressure	The point at which the electrons are pushed into the nucleus of an atom.
Neutron Star	A large star, at the end of its life. If it is between 1.4 and 3 solar masses, the atoms will all collapse upon themselves and become a giant ball of neutrons.
Newtonian Focus	The point where the image is in focus in a reflecting telescope after bouncing off the secondary mirror and exiting the tube near the top end.
Newtonian Telescope	The type of telescope that Isaac Newton invented. It is a simple reflector utilizing the Newtonian Focus.
Nova	A surface explosion on a white dwarf that is collecting material from its companion (Semi-Detached Binary). When the white dwarf collects enough material and the temperature rises enough, violent Hydrogen Fusion ignites on the surface of the White Dwarf and material is blown off into space.
Nuclear Epoch	Continued expansion of the Universe, from 100 seconds to 50,000 years after the big bang, has caused it to cool to the point where Protons and Neutrons are not destroyed by high-energy photons, and also Deuterium, and Helium can be formed.
Nucleus	The center of an atom containing Protons and Neutrons.
Olber's Paradox	If the Universe is infinite, Homogeneous, and Isotropic, then no matter where you look you will see light from a star. If this were true, then the Universe at night should be as bright as the surface of the sun. There should be no dark nighttime skies. Of course there is.
Olympus Mons	The largest volcano in the Solar System.
Oort Cloud	A large sphere of cometary bodies well beyond the Kuiper Belt.
Open Cluster	Star Clusters that are thousands of stars. They formed relatively recently and over time will drift apart.
Open Universe	The Universe is shaped like a saddle. Space is curved, but is infinite.
Opposition	The point when a superior planet is on the opposite side of the Earth from the Sun.
Outflow Channels	Evidence on the surface of Mars apparently caused by large amounts of flowing water moving from the highlands to the plains.
Ozone Layer	A layer in the Stratosphere where Ultraviolet Radiation from the Sun is absorbed by Ozone (O <sub>3</sub> ) and Nitrogen.
Pair Production	In the early Universe photons of very high energy would collide and create a pair of particles (for example, a

## Astronomy for Mere Mortals – An Introductory Astronomy Text

	positron and an electron). These particles would find each other and almost immediately annihilate each other and turn back to photons.
Pangaea	The name of the continent formed about 200 million years ago that was broken apart by Continental Drift.
Pencil Beam Theory	A survey of Galaxies that cover a small field but looks deep into the Universe. It is pencil shaped.
Penumbra	The lighter outer portion of a Sunspot.
Phobos	One of Mars' moons, probably a captured Asteroid.
Photoelectric Effect	The effect discovered by Einstein that proves that light behaves like particles, not just waves.
Photometry	The measurement of the strength or brightness of an astronomical object.
Photons	The particle form of electromagnetic radiation.
Photosphere	The surface of the Sun. This is the layer that we see in a telescope with a simple solar filter.
Planet	A body that is orbiting a star (or the Sun) that must meet these three requirements in our Solar System: Massive enough to become basically a sphere, orbit the sun, and are massive enough to have cleared their orbit of debris.
Planetary Nebula	The final result of oscillations in a Sun-like star resulting in the outer layers of the Atmosphere being blown off in a growing bubble. The Core collapses into a White Dwarf.
Planetary Transits	A common technique for detecting planets around other stars as they move across the face of their star and cause a slight dimming in the star's luminosity.
Planetesimals	Small objects that continue to grow into Planets.
Planck Epoch	The first $10^{-43}$ seconds after the Big Bang. Our theories can't tell us what occurred at this time. All four fundamental forces were unified at this time.
Plate Tectonics	The motion of large chunks of the Earth's Crust. Also known as Continental Drift.
Polarized Light	Light waves oriented in the same direction.
Prime Focus	The point where the image is in focus in a reflecting telescope after only bouncing off the primary mirror.
Prism	A triangular piece of glass in a spectroscope that causes the different frequencies of light to separate.
Prominences	Loops and sheets of the Sun's materials that rise above the surface of the Sun along the magnetic field lines. They may last for days.
Proton-Proton Chain	The nuclear fusion reaction that combines protons to produce Helium. It is the more common process believed to occur in smaller stars.
Protons	Not so small positively charged particles that exist in the nucleus of an atom.
Protoplanets	Larger objects that are almost formed into Planets.



## Astronomy for Mere Mortals – An Introductory Astronomy Text

Protostar	The stage of a star's life after it has collapsed into a sphere, but before it has begun nuclear Fusion.
Protostellar Disk	The disk of material surrounding a Protostar that will eventually form into the planets.
Protostellar Winds	The strong winds that radiate from stars while they are forming and in the Protostar Stage. These often appear as jets of material streaming from the poles of the protostar.
Pulsar	A rapidly rotating neutron star when the magnetic axis is different from the rotation axis. Material that is ejected from the magnetic poles rotates around and once each cycle is pointed at the Earth.
Quark	A tiny particle of which Protons and Neutrons are composed. There are believed to be six types: Up, down, Top, Bottom, Charm, and Strange. This is the smallest particle that we have detected.
Quark Epoch	From $10^{-35}$ to $10^{-4}$ seconds after the Big Bang. The Strong Nuclear Force follows Gravity and they are both separated from the other two fundamental forces. This is followed by the Weak Nuclear Force separating from the Electromagnetic Force as well, leaving the four separate fundamental forces we know today. The energy level has dropped to the point where Quarks can form and are not destroyed by high-energy photons.
Quasars	Very early Active Galaxies.
Radiant	The point in the sky that all meteor trails seem to have originated from in a Meteor Shower.
Radiation	The release of energy by some rare heavy elements.
Radiation Dominated	In the early Universe, matter could not form. At that time, there was much more energy than matter.
Radiation Era	The period when the Universe was Radiation Dominated. It includes these Epochs: Planck, GUT, Quark, Lepton, and Nuclear.
Radiation Zone	The region of the Sun's interior outside the Core.
Radio Galaxy	An Active Galaxy that is shooting jets of material into nearby space resulting in glowing Radio Lobes.
Radio Telescope	A telescope designed to detect electromagnetic radiation in the radio part of the spectrum.
Radio Waves	The wavelengths at the long end of the spectrum.
Rayleigh Scattering	The scattering of blue light in Earth's Atmosphere. This is why the sky is blue.
Red Giants	Large red stars in the final stages of their lives.
Red Shift	When an object is moving away from you, the lines in the

## Astronomy for Mere Mortals – An Introductory Astronomy Text

	light being emitted are moved in the red direction (longer wavelengths).
Red Shift Surveys	Surveys of the Universe studying the Red Shift of Galaxies in a specific area to determine the distribution of Galaxies.
Reddening	Dust and gas thick enough to cause the scattering of blue light from distant stars before it can reach Earth. This results in these stars appearing to be redder than they really are.
Reflection Nebulae (singular is Nebula)	Clouds of dust and gas that glow in the blue from photons that are scattered as they pass through. This is due to Rayleigh Scattering and is blue for the same reason that the sky on Earth is blue.
Reflector	A telescope that uses primarily mirrors to focus light.
Refractor	A telescope that uses primarily lenses to focus light.
Regolith	Regolith – The dust on the surface of the moon that is the result of continuous impacts of meteors.
Retrograde Motion	The apparent backwards movement of superior planets through the sky as seen from Earth.
Right Ascension	Right Ascension - imaginary lines in the sky that go from celestial north to celestial south. The sky is broken up into 24 major pieces (hours) and each of these has 60 minutes, and each minute has 60 seconds.
Rings	All of the Jovian Planets have rings. Saturn's rings are spectacular and are the only ones visible from Earth.
Roche Limit	The distance from a planet within which dust will not form into a moon due to the gravitational stress.
Roche Lobes	The theoretical limiting distance from a star beyond which its matter will flow to its binary companion.
Rotation Curve	The speed of rotation as a function of distance from the Galaxy's Core.
Rotational Flattening	An object that is a sphere flattens somewhat when it is rotated.
ROYGBV	The colors of light in the visible part of the spectrum, from longest wavelength to shortest wavelength: Red, Orange, Yellow, Green, Blue, and Violet.
R-Process	The rapid Neutron Capture process. Neutrons are captured by atoms at a very high rate. Atoms created do not have to be stable for a very long time. This process created atoms up to Uranium.
Runaway Greenhouse Effect	Runaway Greenhouse Effect – the very high atmospheric temperatures found on Venus due to the large amount of carbon dioxide in the atmosphere.
Runoff Channels	Extensive networks of channels showing movement of water.
Scarp	Scarp – large cliff on Mercury caused by the cooling of the

## Astronomy for Mere Mortals – An Introductory Astronomy Text

	planet and the surface folding.
Schwarzschild Radius	Also known as the Event Horizon. This is the distance from the Black Hole at which the Escape Velocity is equal to the Speed of Light.
Scientific Method	An approach to solving mysteries. Consists of three parts: Observation, Theory, and Prediction.
Scientific Theory	A proposal to describe why things behave the way they do. Since we cannot ever try all of the possibilities, we can never prove it. Only one failure can disprove it. It must be continually tested.
Seeing	In astronomy, the stability of the air. It directly affects your ability to focus an object in a telescope.
Seismic Waves	Vibrations that travel through the Earth and can be measured by surface detectors. They can be used to determine the Earth's internal structure.
Selection Effect or Selection Bias	The tendency to find large Hot Jupiters due to biases in our detection methods.
Semi-Detached Binary	A binary star system where one star has expanded beyond its Roche Lobe and is sharing material with the other.
Semi-Major Axis	The major axis is the longest line through an ellipse. The Semi-Major Axis is half of its length.
SETI	The Search for Extraterrestrial Intelligence. These are efforts using radio telescopes to detect signals from intelligent species out there in the Galaxy. There have been no successes as of this time.
Seyfert Galaxies	Active Galaxies that resemble normal Spiral Galaxies, but they are very active.
Shepherd Moons	Small moons on either side of a ring that gravitationally keep the rings organized.
Shepherd Satellites	Small moons on either side of a ring that gravitationally keep the rings organized.
Shield Volcanoes	The large volcanoes found on Venus <b>that</b> are formed over long periods of time by a hot spot in the planet's crust.
Singularity	The point of all matter and energy in a Black Hole's center.
Slingshot	The technique for sending a spacecraft close to a planet to use the planet's gravity to add speed and change direction.
Solar Nebula	The rotating cloud of dust and gas that surrounded the Sun and eventually became our Solar System.
Solar Neutrino Problem	The fact that there are fewer neutrinos detected than are expected due to the rates of production in the Sun's Core through Fusion.
Solar System	This is the environment around the Sun. It is the collection of all objects that are influenced by the Sun. It includes the Sun (sol), the planets, the dwarf planets, the moons, the asteroids, the comets, the meteors, the Kuiper Belt

## Astronomy for Mere Mortals – An Introductory Astronomy Text

	objects, the Oort Cloud objects, and the solar wind.
Solar Wind	The charged particles flying away from the Sun.
Spacecraft	A man-made object that is sent into space for exploration and scientific study.
Special Theory of Relativity	The scientific theory developed by Einstein that says Energy can be converted to Matter and vice versa.
Spectroscopic Binaries	Binary Stars that are too close together or too far away to be separated visually, but can be separated by observing changes in the spectra.
Spectroscopic Parallax	The technique of determining a star's distance based on its placement on the HR Diagram and its Apparent Magnitude.
Spectroscope	A tool used to observe the spectra being emitted from an object.
Spectrum	All of the different wavelengths or frequencies of electromagnetic radiation combined.
Spiral Density Waves	Pressure waves (compression) that travel through the Galactic Disk and are responsible for the formation and persistence of the Spiral Arms.
Spiral Galaxies	A galaxy with spiral arms in a flat Galactic Disk. They typically have billions of stars.
S-Process	The slow Neutron Capture process. Each neutron is captured by an atom at a rate of about once every few decades. This produces elements up to Bismuth and occurs in the final stages of normal Fusion in the star's Core. To succeed the atom created must be stable enough not to decay before the next neutron comes along.
Standard Candles	Type I Supernovae have a standard absolute Magnitude. This combined with the Apparent Magnitude can be used to calculate the distance.
Star	A large ball of gas where the temperature and pressure in the core is adequate to support nuclear fusion.
Star Clusters	Groups of stars (from a few to millions) that were born from the same Nebula. They can be Open Clusters or Globular Clusters.
Starburst Galaxy	A Galaxy with lots of new stars being created. This is due to mergers or some other kind of interaction with other Galaxies.
Stellar Epoch	From 3 billion years to 10 billion years after the Big Bang. Galaxy formation has stopped but star formation continues. This brings us to the present time.

## Astronomy for Mere Mortals – An Introductory Astronomy Text

Stellar Nucleosynthesis	The formation of the elements in a star.
Stellar Parallax	The ability to calculate the distance to an object by noting the angle associated with the object's position relative to background stars from two different observing locations.
Stratosphere	The layer in the Earth's Atmosphere above the Troposphere. This is the top of the biggest clouds and also where the Ozone Layer is.
Strong Force	This is the fundamental force that holds together the Protons and Neutrons in the nucleus of atoms. It is a very strong force, but has a very limited range.
Subduction Zone	Places where one tectonic plate slips under another plate.
Sunspot Cycle	Every 11 years, the magnetic poles of the Sun switch. When this occurs, the Sunspots go through a change from a minimum through a maximum.
Sunspots	Regions on the Sun's surface that are active magnetically. They are slightly cooler than the rest of the surface and therefore appear darker.
Superclusters	Very larger clusters of Galaxy Clusters. They have a common center around which they all rotate and are gravitationally bound together.
Superior Planets	The planets whose orbits are outside of the Earth's orbit: Mars, Jupiter, Saturn, Uranus, and Neptune.
Superior Conjunction	The point when an inferior planet is on the opposite side of the Sun from the Earth.
Supermassive Black Holes	The very large Black Holes in the center of almost all galaxies.
Supernova	When a large star has made iron in its core, Fusion will cease. When this occurs, a very violent explosion blows dust and gas out into space. This is a Type II Supernova.
Synchronous Orbit	Synchronous Orbit – When the spin of an object equals its orbital period around another object. The Moon is in a Synchronous Orbit. The result is that the same side of the Moon is always facing the Earth. This is also known as being Tidally Locked.
Synchrotron Radiation	The radiation emitted by charged particles as they spiral around magnetic field lines.
Terrestrial Planets	Those planets that are Earth-like; have a rocky surface: Mercury, Venus, Earth (Terra), and Mars.
Tharsis Bulge	A large bulge in the surface of Mars.
Thermal Radiation	Thermal Radiation - the wavelength of electromagnetic radiation that is emitted from an object. The wavelength corresponds to the temperature. Cool objects radiate in the infrared, warmer objects in the red, up to hotter objects in the violet.

## Astronomy for Mere Mortals – An Introductory Astronomy Text

Tidal Bulge	The bulges in the water on Earth caused by the gravity of the Moon and the Sun
Tidal Force	The force from the Moon and the Sun that causes the Tides on Earth.
Tidally Locked	Tidally Locked – When the spin of an object equals its orbital period around another object. The Moon is in a Tidally Locked to the Earth. The result is that the same side of the Moon is always facing the Earth. This is also known as being a Synchronous Orbit.
Tides	Tides are results from the gravitational attraction of one body on another. For example the rising and lowering of oceans on Earth are caused by gravitational attraction of the moon and the sun.
Time Dilation	The expansion of time in the vicinity of a large mass.
Titan	Saturn's only large moon. It is very similar to the Galilean Moons at Jupiter.
Transition Zone	The region of the Sun's Atmosphere above the Chromosphere and below the Corona.
Troposphere	The bottom layer of the Earth's Atmosphere. The place where the weather happens.
Trough	The low point on the curve of a wave.
Tully-Fisher Relation	A relationship that related the rotation rate for a galaxy with its absolute magnitude. This relationship, when used with the Apparent Magnitude, enables you to calculate the distance to the Galaxy.
Tuning Fork Diagram	A model for classifying the different types of Galaxies.
Ultraviolet Light	The wavelengths in the spectrum above visible light.
Ultraviolet Telescope	Ultraviolet Telescope - a telescope designed to detect electromagnetic radiation in the ultraviolet part of the spectrum.
Umbra	The dark central part of a Sunspot or the dark part of the Earth's shadow that is the location of the moon during a lunar eclipse.
Urey-Miller Experiment	An experiment that produced Amino Acids in the laboratory by mimicking the early environment on Earth.
Valles Marineris	A very large valley on Mars, many times larger than the Grand Canyon.
Van Allen Radiation Belts	Regions in the Earth's Magnetosphere where charged particles are trapped by the Earth's Magnetic Field.
Variable Stars	Stars that exhibit a characteristic brightness curve. Noting the period of the curve we can calculate the absolute magnitude. And by measuring the Apparent Magnitude we can calculate the distance. There are two types: RR-Lyrae and Cepheid variables.

## Astronomy for Mere Mortals – An Introductory Astronomy Text

Visible Light	The wavelengths that we can see.
Visual Binaries	Stars that are either far enough apart or close enough to Earth that we can visually separate them.
Voids	Areas in the Universe where there seem to be virtually no Galaxies.
Water Hole	A range of frequencies in the Electromagnetic Spectrum where there is very little background noise in the Universe. It is just above 1 gigahertz.
Wavelength	The distance between two crests of a wave.
Waves	The wave form of electromagnetic radiation.
Weak Force	This is a fundamental force that governs radioactive decay in atoms. It has a very short range.
White Dwarfs	The small white core that is the remnant of a star after fusion has ceased.
X-Ray Bursters	Violent high-energy eruptions from a Neutron Star in a Binary Star system. It is caused by material from the companion star falling on the surface of the Neutron Star. As the gas and dust builds up and temperatures rises and a short but intense burst of X-Rays is created.
X-Ray Telescope	A telescope designed to detect electromagnetic radiation in the x-ray part of the spectrum. These telescopes use nested rings as mirrors to make the reflection angle shallow and allow the focusing of x-ray photons.
X-Rays	The wavelengths of electromagnetic radiation that are even shorter than ultraviolet light.
Zenith	The point above your head at 90 degrees Altitude.
Zonal Flows	The rotation of the atmosphere on a gaseous object (Jovian Planet or the Sun) that varies depending on latitude. Also known as Differential Rotation.
Zones	The brighter lines on the cloud tops of Jupiter. They are the upwelling of atmospheric material. See Belts.

## Appendix 5 – The Sun’s Stellar Neighborhood

Dist (ly)	System	Designation Star	Stellar Class	Mv	Discovery Date	Notes and additional references
0	Solar System	Sun	G2V	4.85	—	has eight known planets
4.2421	Alpha Centauri - (Rigel Kentaurus)	Proxima Centauri (V645 Centauri)	M5.5Ve	15.53	1915	
4.365		$\alpha$ Centauri A (HD 128620)	G2V	4.38		
		$\alpha$ Centauri B (HD 128621)	K1V	5.71	1689	has two suspected planets (b & c)
5.963	Barnard's Star (BD+04°3561a)		M4.0Ve	13.22	1916	largest known proper motion
6.59	Luhman 16 - (WISE 1049–5319)	Luhman 16A	L8	14.2 J	2013	has one suspected planet
		Luhman 16B	T1			has one suspected planet
7.2	WISE 0855–0714		Y		2014	sub-brown dwarf
7.7825	Wolf 359 (CN Leonis)		M6.0V	16.55	1919	
8.2905	Lalande 21185 (BD+36°2147)		M2.0V	10.44	1801	
8.5828	Sirius - ( $\alpha$ Canis Majoris)	Sirius A	A1V	1.42		brightest star in the night sky
		Sirius B	DA2	11.34	1844	brightest star in the night sky
8.728	Luyten 726-8	Luyten 726-8 A (BL Ceti)	M5.5Ve	15.4	1949	
		Luyten 726-8 B (UV Ceti)	M6.0Ve	15.85		
9.6813	Ross 154 (V1216 Sagittarii)		M3.5Ve	13.07	1925	
10.322	Ross 248 (HH Andromedae)		M5.5Ve	14.79	1925	
10.522	Epsilon Eridani (BD–09°697)		K2V <sup>[2]</sup>	6.19	150	at least one planet
10.742	Lacaille 9352 (CD–36°15693)		M1.5Ve	9.75	1753	
10.919	Ross 128 (FI Virginis)		M4.0Vn	13.51	1925	
11.089	WISE 1506+7027		T6	16.6 J	2011	
11.266	EZ Aquarii - (Gliese 866, Luyten 789-6)	EZ Aquarii A	M5.0Ve	15.64	1937	
		EZ Aquarii B	M	15.58	-	
		EZ Aquarii C	M	16.34	1995	
11.402	Procyon - ( $\alpha$ Canis Minoris)	Procyon A	F5V–IV	2.66		
		Procyon B	DQZ	12.98	1844	
11.403	61 Cygni	61 Cygni A (BD+38°4343)	K5.0V	7.49	1725	first star (other than the Sun) to have its distance measured
		61 Cygni B (BD+38°4344)	K7.0V	8.31	-	
11.525	Struve 2398 - (Gliese 725, BD+59°1915)	Struve 2398 A (HD 173739)	M3.0V	11.16	1835	
		Struve 2398 B (HD 173740)	M3.5V	11.95		
11.624	Groombridge 34 - (Gliese 15)	Groombridge 34 A (GX Andromedae)	M1.5V	10.32	1813	has one planet
		Groombridge 34 B (GQ Andromedae)	M3.5V	13.3	-	
11.824	Epsilon Indi - (CPD–57°10015)	Epsilon Indi A	K5Ve	6.89	1597	one suspected planet
		Epsilon Indi Ba	T1.0V		2003	
		Epsilon Indi Bb	T6.0V		2003	
11.826	DX Cancri (G 51-15)		M6.5Ve	16.98	1972	
11.887	Tau Ceti (BD–16°295)		G8Vp	5.68	150	possibly five planets
11.991	GJ 1061 (LHS 1565)		M5.5V	15.26	1995	
12.068	WISE 0350–5658		Y1		2011	
12.132	YZ Ceti (LHS 138)		M4.5V	14.17	1961	
12.366	Luyten's Star (BD+05°1668)		M3.5Vn	11.97	1935	
12.514	Teegarden's star (SO025300.5+165258)		M6.5V	17.22	2003	possible planetary system
12.571	SCR 1845-6357	SCR 1845-6357 A	M8.5V	19.41	2004	
		SCR 1845-6357 B	T6		2006	
12.777	Kapteyn's Star (CD–45°1841)		M1.5V	10.87	1898	has two known planets
12.87	Lacaille 8760 (AX Microscopii)		M0.0V	8.69	1753	
13.149	Kruger 60 - (BD+56°2783)	Kruger 60 A	M3.0V	11.76	1880	
		Kruger 60 B (DO Cephei)	M4.0V	13.38	1890	
13.167	DEN 1048-3956		M8.5V	19.37	2001	
13.259	UGPS 0722-05		T9		2010	
13.349	Ross 614 - (V577 Monocerotis, Gliese 234)	Ross 614A (LHS 1849)	M4.5V	13.09	1927	
		Ross 614B (LHS 1850)	M5.5V	16.17	1936	
13.82	Wolf 1061 (Gliese 628, BD–12°4523)		M3.0V	11.93	1919	



## Astronomy for Mere Mortals – An Introductory Astronomy Text

Dist	Designation		Stellar	Mv	Discovery	Notes and additional
(ly)	System	Star	Class		Date	references
0	Solar System	Sun	G2V	4.85	—	has eight known planets
14.066	Van Maanen's star (Gliese 35, LHS 7)		DZ7	14.21	1896	
14.231	Gliese 1 (CD-37°15492)		M1.5 V	10.35	1884	
14.312	Wolf 424 - (FL Virginis, LHS 333, Gliese 473)	Wolf 424 A	M5.5Ve	14.97		
		Wolf 424 B	M7Ve	14.96		
14.4	2MASS J154043.42-510135.7		M7V	17.04	2014	
14.509	L 1159-16 (TZ Arietis, Gliese 83.1)		M4.5V	14.03		
14.793	Gliese 687 (LHS 450, BD+68°946)		M3.0V	10.89		has one known planet
14.805	LHS 292 (LP 731-58)		M6.5V	17.32		
14.809	Gliese 674 (LHS 449)		M3.0V	11.09		has one known planet
14.812	G 208-44	G 208-44 A (V1581 Cyg)	M5.5V	15.17		
	G 208-44	G 208-45	M6.0V	15.72		
	G 208-44	G 208-44 B	M5.5	18.46		

## Appendix 6 – The History of Astronomy

**Copyright © 2018 David Tomlin.** All Rights Reserved. No part of these materials may be reproduced or distributed without the prior written permission of the author. This work is included here with permission by the author.

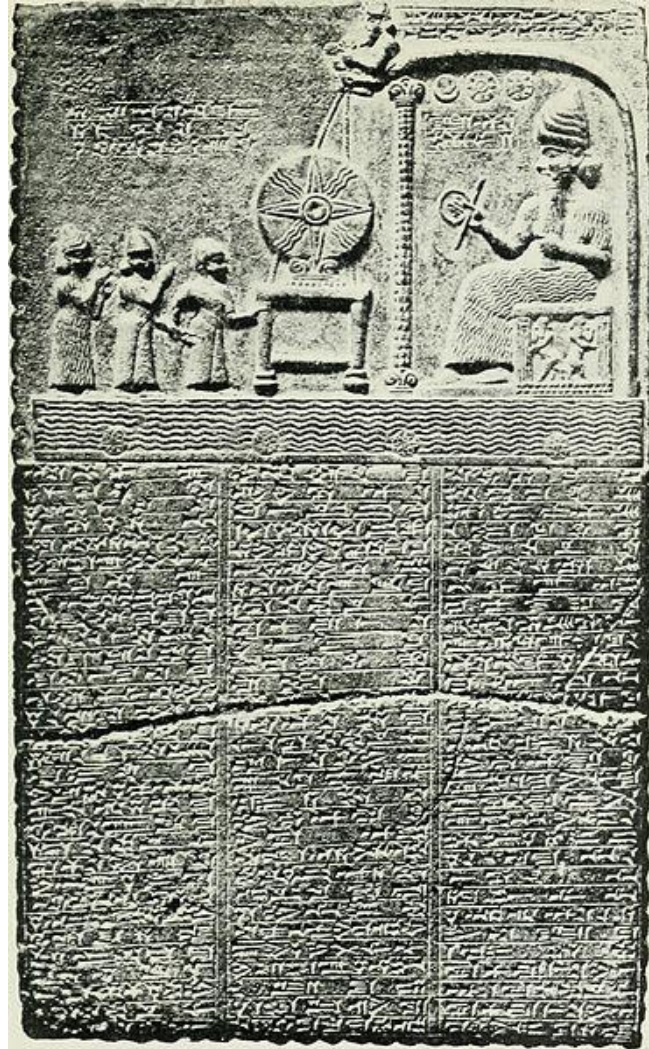
### Ancient Astronomy

Undoubtedly, pre-historic humans studied the night sky. Large stone structures oriented to various points in the sky litter the landscape on most of the world's continents. But it is not until historic eras, that is, since the invention of written records, that we can be certain what the ancients thought was important, and in some cases, why they recorded their observations.

The earliest of these records trace back to the ancient Near East, to that region of modern-day Iraq we now refer to as Babylon. The priestly caste of the Babylonians, the Chaldeans, began to produce astronomical records on clay tablets dating back to about 1800 BCE.

The observations at that time were mainly about the Sun, Moon, and Venus. Later, they included all of the other planets as well. The Babylonian achievement lies in the fact that they were eventually able to create mathematical algorithms for each of these objects, making predictions of their motions possible. This was the first time in recorded history that mathematics was combined with observations to make predictions that were reasonably accurate. Over the centuries they continued to refine their predictions by continued observation, which was a chief function of the Chaldeans in Babylonian society.

Figure 455: Chaldean Tablet



Public Domain

From other clay tablets, archeologists have been able to determine that the reasons for this long-term institutional commitment to astronomy were primarily religious. Out of all the objects visible in the night sky, just seven change their positions relative to all the other “fixed” stars. This fact was determined by the Babylonians (and other world civilizations) to have meaning, especially as these changing motions were regular enough to be predictable. For the Babylonians, this regularity seemed to mean that the gods were communicating with them (or at least to the Chaldean priests). This attempt to attach meanings to the motions of the planets became the basis for astrology.

From the standpoint of the significance for modern astronomy, we should note that the Babylonian achievement was limited to algorithms. That is, they had no theory of planetary movement; rather, they were able to create step-by-step procedures to achieve their purposes. They created no models of the heavens, though they did do some mapping of the skies.

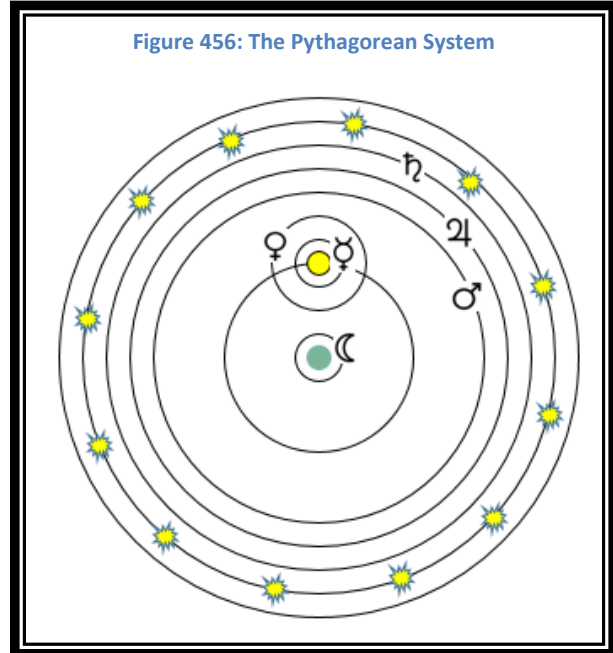
Much the same can be said for the Egyptians, who oriented some of their pyramids and temple complexes to various celestial objects. But again, they did not create astronomical models, and their interest in the heavens dealt mainly with navigating the soul through the afterlife.

## **The Ancient Greeks**

It isn't until we come to the Ancient Greeks, about 600BCE, that we find a significant new development in how to approach the study of nature. For the first time in the written record, we find speculations about the functioning of nature that “left the gods out.” This is now referred to as the beginning of philosophy. This is not to say that Greek civilization did not have religion – far from it! But a handful of philosophers created, and kept alive through each new generation, an approach to nature that we recognize today as the beginnings of science. And astronomy was the key to that new tradition.

There are several philosophical traditions, or schools, that we could discuss, but we will limit ourselves to those that relate most directly to the development of astronomy. The first is Pythagoras of Samos, who flourished about 530 BCE. After travelling throughout the Mediterranean and the Near East, Pythagoras settled in southern Italy, where he founded a community of scholars. The Pythagorean School existed for several decades, and was committed to the study of Number as the underlying reality of the Cosmos. We are all familiar with the Pythagorean Theorem for right triangles, and they went on to develop the idea of mathematical proofs for their propositions. The Pythagoreans were the first to sketch out geocentric models of the heavens. One cosmology, attributed to Philolaus of Croton (5<sup>th</sup> century BCE), placed at the center of the universe a “central fire” (*Hestia*), with both the Sun and the Earth in orbit around it.

Another system, proposed by a Pythagorean named Heraclides of Pontus (4<sup>th</sup> Century BCE), placed the Earth at the center, with the other planets in orbit around the Earth, except for Mercury and Venus, which revolved around the Sun. This would explain why Mercury and Venus never get very far from the Sun “like dogs on a leash, sometimes running ahead and sometimes running behind.” He even suggested that the Earth rotated on its axis once per day, but this was never widely accepted.



But the main contribution of the Pythagoreans was to introduce the idea of moving spheres around a fixed Earth. The seven planets (the Sun and Moon were considered planets, “planetoi” – Greek for “wanderers” – along with Mercury, Venus, Mars, Jupiter, and Saturn) were conceived to be embedded in a series of concentric spheres. Each sphere was supposed to be made of a pure crystalline material, and the rotation of each sphere around an axis carried its planet around the Earth. An eighth, and final, sphere carried the fixed stars. The spheres had to be perfectly transparent so that Earthly observers would be able to see more distant planets through the spheres carrying the closer planets.

### **The Problem of the Planets**

Unfortunately for Pythagoras, things just weren’t that simple. One of the later Pythagoreans was an aristocrat named Plato who founded his school, the Academy, at Athens in 388 BCE. Plato was the first to state the Problem of the Planets, and he also set the terms for solving it that held for the next 2000 years.

The Problem of the Planets has three components:

1. Planetary motions involve changes in speed.
2. Planetary motions involve changes in brightness.
3. Planetary motions involve changes in direction.

A satisfactory solution must account for all three components: it must “save the phenomena.”

Plato went on to state the rules by which a solution must be found: a successful model would employ only constant speeds (what he called “uniform motion”); and all motions must be

perfectly circular. So how could uniform circular motion solve the Problem of the Planets, especially since the Pythagorean model had already failed at just that?

### The Platonic 2-Sphere Model

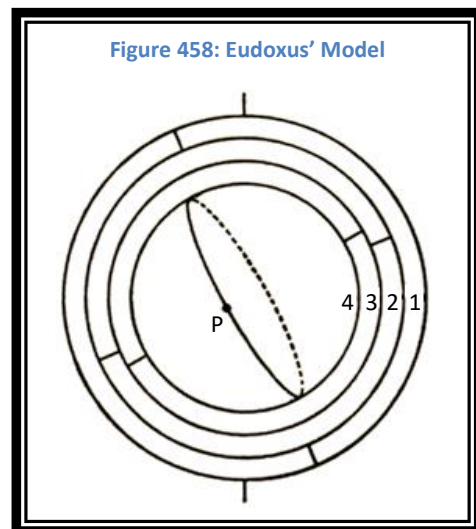
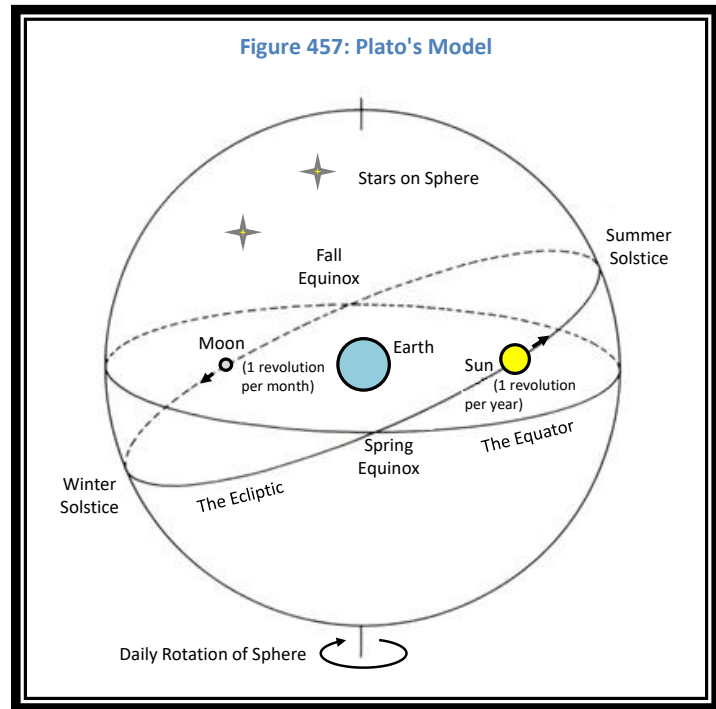
Plato was well aware of the shortcomings of the mathematics of his day, so he knew that “uniform circular motion” was as far as their limited mathematics could take them. But if you could combine simple motions in clever ways, it might just be possible to find solutions for more complex problems. Plato only sketched out a

solution by beginning with his 2-sphere model. The Earth is the small sphere at the center, fixed and unmoving. The larger sphere contains the fixed stars, and shows the apparent path of the Sun along the Ecliptic, which is tilted at an angle of about  $23.5^\circ$  to the celestial equator. The large sphere rotates once each day, which accounts for the daily rising and setting of the stars and planets. The planets travel along the Ecliptic (the Sun and Moon are shown here, taking one year, and one month, respectively, to make one revolution around the Earth).

Since Plato was not really very interested in mathematical problems (he was much more concerned with philosophy and ethics, like his teacher Socrates), he passed these ideas along to his pupil, Eudoxus of Cnidus. Eudoxus sought to improve on Plato’s model by adding more spheres, each with its own axis of rotation, each designed to deal with the Problem of the Planets. This led to the Eudoxan 4-sphere model.

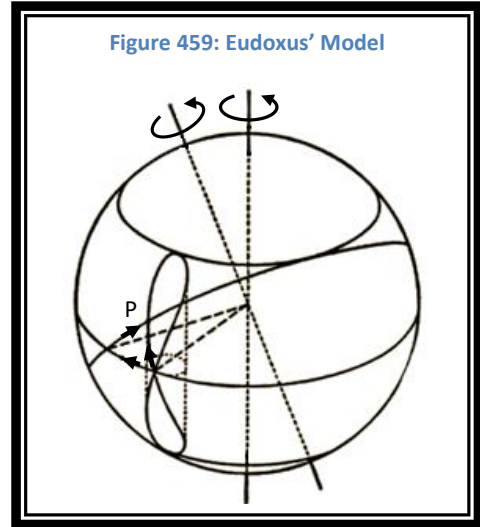
### The Eudoxan 4-Sphere Model

Eudoxus came up with a model designed to address all three components of the Problem of the Planets. Each planet had its own set of concentric spheres. If planet P in the diagram is, say, Mars, then the outermost sphere



(1) is responsible for the daily 24-hour motion; sphere (2), which revolves in the opposite direction, takes 687 days for one rotation, to account for Mars' slow sidereal motion; spheres (3) and (4), which rotate opposite each other, in combination produce retrograde motion, in the form of a figure eight, called a hippopede.

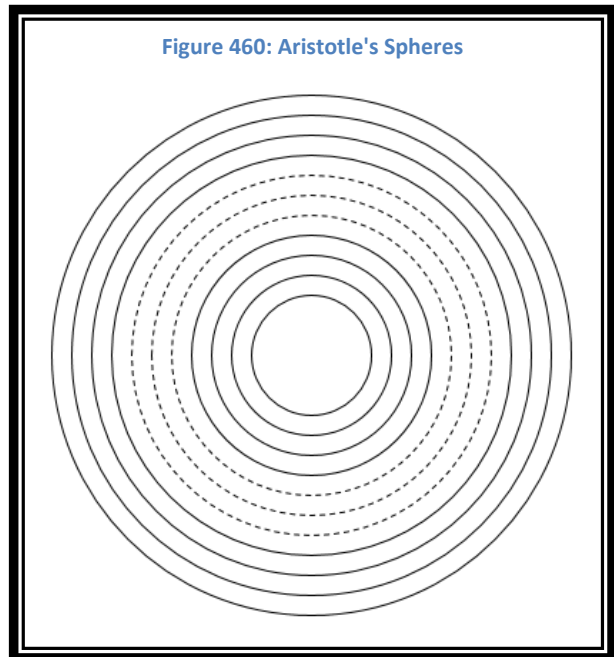
From the figure you can see that at times the planet moves forward and at other times it moves backward, or retrograde. Eudoxus created a set of 4-sphere models for each planet, except for the Sun and the Moon, which do not exhibit retrograde motion and therefore only need three spheres each.



From the existing texts, it seems clear that Plato and his school were looking for a mathematical solution, not a mechanical one. Each planet in the Eudoxan scheme was considered separately.

### Aristotle's Contribution

Another of Plato's students was Aristotle of Stagira, in Macedon. In addition to serving as the teacher of Alexander the Great, Aristotle's fame lies in his founding his own school, the Lyceum, also in Athens, after the death of Plato. Aristotle's approach to nature emphasized the real world much more than Plato's idealistic approach. So when he began to deal with the Problem of the Planets, he sought out solutions that would work mechanically as well as mathematically. He liked what Eudoxus had done, but he felt it needed modification if it was going to represent a real system.



In the figure, the solid-line circles represent the Eudoxan spheres for two adjacent planets, like Jupiter and Saturn. So the inner four circles are the Eudoxan spheres for Jupiter, and the outer four circles represent the Eudoxan spheres for Saturn. In between – the dotted line circles – are three new spheres introduced by Aristotle. These new spheres were introduced to subtract off the motions of the innermost three spheres of Saturn so that their motion would not be transmitted inward to the motion of Jupiter. Only the outermost sphere's motion of Saturn –

the motion for daily 24-hour motion - would be allowed to transfer all the way in to Jupiter's outermost sphere. In similar fashion, all the planets would have additional counter-rotating spheres to subtract off motions of planetary spheres as you work your way all the way in to the innermost spheres for the closest "planet" to the Earth, the Moon. All these new spheres were designed, at least in principle, to make it possible to model the Cosmos in a working mechanical system. In all, Aristotle's model added up to 55 concentric crystalline spheres rotating around a fixed Earth.

Aristotle's scheme would become orthodoxy for the next two millennia, because he wrote so extensively on a huge array of topics which were copied by his students and eventually codified in written texts. But there were a few significant mathematical innovations in succeeding centuries that went well beyond the Eudoxan approach. And one innovator even put the Earth in motion around the Sun.

### **Aristarchus of Samos**

Not much is known about Aristarchus, who flourished in Alexandria, Egypt around 285 BCE. Only one of his works survives, in which he calculated the ratio of the Moon's distance from Earth to that of the Sun's distance from Earth. His mathematical reasoning was correct, but the inaccuracies in observational measurements available to him made his final result well off the mark.

But Aristarchus is best known today for introducing and defending the notion that the Earth both rotated once each day, and that the Earth revolved around the Sun once each year. We know he got it right; but this model was almost universally rejected in his day. The arguments against the heliocentric (Sun-centered) system, and for the geocentric (Earth-centered) system, were both cultural and scientific.

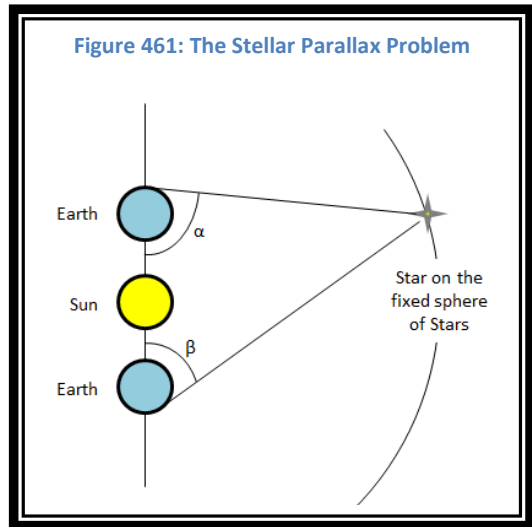
The heliocentric system violated centuries of tradition. All the cultures of the Near-Eastern and Mediterranean regions were represented in the melting-pot of Alexandria, where the great Library and Museum concentrated the intellectual wealth of the ancient world. And all of the cultures there believed in an Earth-centered system of the Cosmos. Aristarchus's heliocentrism flew in the face of all that tradition.

Heliocentrism also flew in the face of terrestrial physics as propounded by Aristotle. For Aristotle, the natural state of motion was rest. For motion to occur, an external force was required. But Aristotle did not develop the concept of inertia, where an object stays in motion unless acted upon by an external force. For Aristotle, a force was needed to start motion, and a force was needed to keep an object moving. He based this idea on common sense: objects slow down and stop unless you keep pushing or pulling on them.

So when Aristarchus stated that the Earth turns on its axis west to east once per day, philosophers objected that if that is so, objects dropped from a tower would hit the ground west of where they were actually observed to hit, right at the base of the tower. What about the wind? Shouldn't there be constant easterly winds if the Earth is spinning underneath them?

But the clinching argument against heliocentrism was the prediction of stellar parallax. In the diagram, the Earth is shown at two positions half a year apart, which would be the extremes of its orbit around the Sun. The location of a star on the sphere of fixed stars should appear to be at different angles when measured by an observer on the Earth, that is, angles A and B should be different. For the opponents of heliocentrism, the fact that no difference was ever observed meant that the Earth did not move. The only argument Aristarchus could give was that the stars were too far away for the difference in angles to be measurable. He was, of course, correct. But the absence of data is never a very strong argument in favor of a hypothesis that predicts the existence of that data.

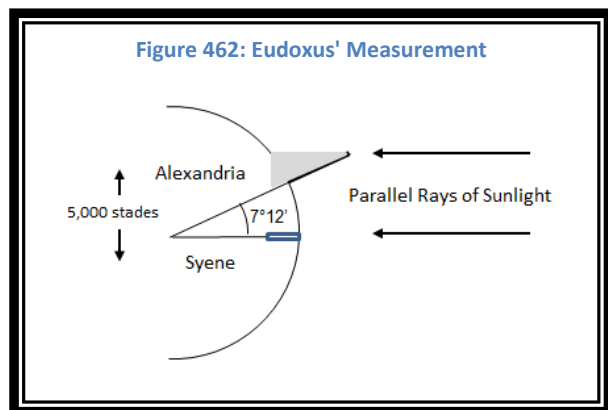
These three arguments against a Sun-centered system were never seriously challenged until Copernicus did so nearly 2000 years later. And as we will see, all of these same arguments were used against Copernicus in his day.



### More Astronomy at Alexandria

Eratosthenes of Cyrene was a scholar at Alexandria in the next generation after Aristarchus. His fame is due to the calculation of the circumference of the Earth with great precision.

The story goes that Eratosthenes had gotten word that a certain well in the Egyptian city of Syene (modern-day Aswan) on the Nile River cast no shadow at the bottom when the Sun was directly overhead on the Summer Solstice. He measured the angle of the shadow cast by a vertical gnomon on the same day in Alexandria, and came up with  $7^{\circ}12'$ . Fortunately, he had a reasonably accurate measure for the distance between Syene and Alexandria because the royal government employed civil servants to



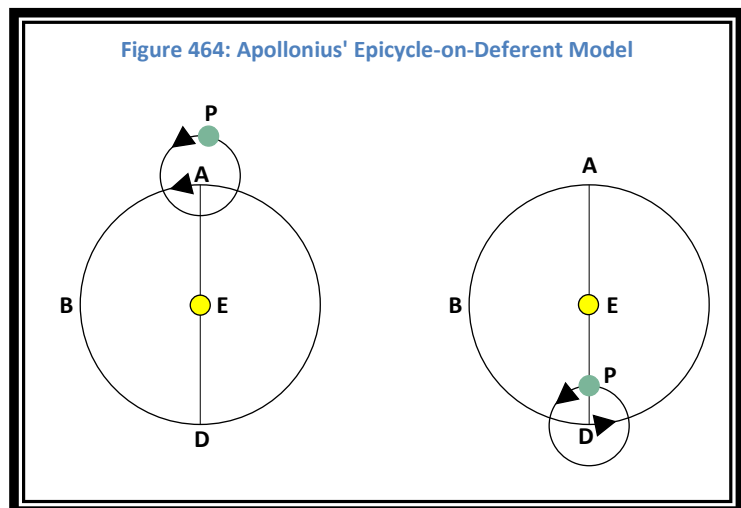
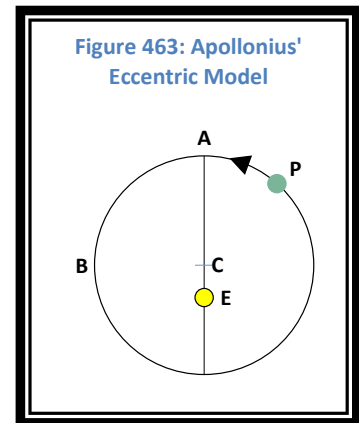


walk between various locations while counting their paces.  $7^{\circ}12'$  is  $1/50^{\text{th}}$  of a circle, and with a distance of 5000 stades paced off between the two locations, he calculated the circumference of the Earth as 250,000 stades. A stade was a standard of measure used widely thereabouts, being the distance for a footrace held at the stadium where the Olympic Games were held. Today, estimates vary about what that distance actually was. But Eratosthenes' reasoning was impeccable, and most scholars credit him with an error of only a few percent. (It is interesting to note that Columbus used the very smallest estimate for the length of a stade so that he could convince potential underwriters of the feasibility of sailing to Asia by going west.)

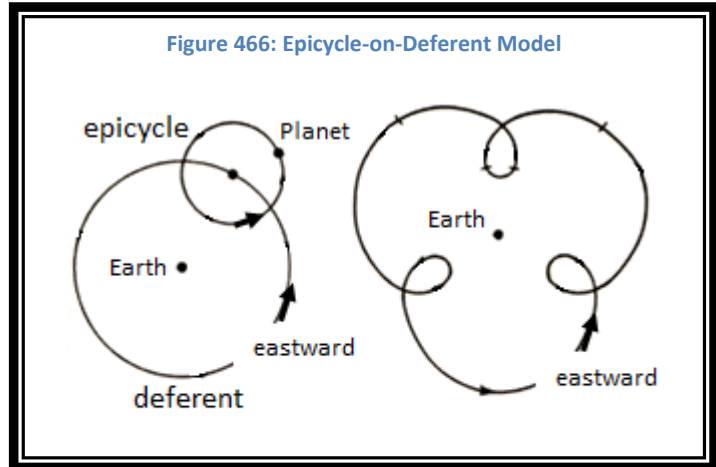
In the generation of scholars after Eratosthenes, Apollonius of Perga made very important contributions to astronomy. He introduced new mathematical models for calculating planetary positions that would be used until Kepler introduced modern methods in the 17<sup>th</sup> century CE.

Apollonius was still dealing with the Problem of the Planets, which had three components. So he came up with three different models for solving each one, still using uniform circular motion.

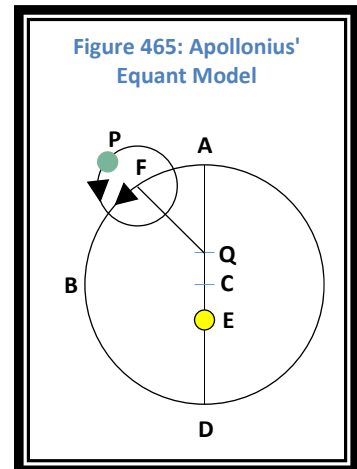
The first was the eccentric model. In the diagram, the planet travels in a circle at a constant speed around its center, C. But the Earth is not located at the center: it is eccentric (off center). This addresses the problem of variations in brightness observed for some of the planets. As you can see, the planet P will sometimes be closer, and at other times will be farther away from the Earth. By choosing values for the speed of each planet, variations in brightness can be modeled for each planet that exhibits such changes. This means that each planet will have its own mathematical model.



The second was the epicycle-on-deferent model. Here you can see that the Earth is located at the center of the large circle, the deferent. On that circle is a smaller circle, called the epicycle. The planet P sits on the epicycle and goes around it using uniform circular motion. But the center of the epicycle moves along the deferent at the same time, also using uniform circular motion. The resulting motion for the planet is a combination of both motions. Notice that in the first diagram the planet is moving in the same direction as the epicycle is moving on the deferent. The second diagram shows what happens at a later time when the planet is moving opposite the motion of the epicycle on the deferent. If you choose appropriate values for speeds of these two motions, it is possible to show how this model can solve another component of the Problem of the Planets, changes in direction, especially retrograde motion.



In this diagram, you can see how the epicycle-on-deferent model introduces a looping motion, where sometimes the planet moves normally, and sometimes moves backward. The numbers show the sequence of these motions. Each of the planets (other than the Sun and Moon) occasionally appears to move backward, so this model was introduced to solve the problem presented by each planet's unique retrograde motion.



The third model introduced by Apollonius was the equant model. This model did not follow Plato's dictum for uniform circular motion, because the equant employs equal angles in equal times. In this diagram, all three models are shown: the Earth is eccentric to the center, C, of the deferent; the planet P is on an epicycle; and the equant point, Q, is the center from which angles are measured for the planet's motion. Since the equant point is also eccentric, and exactly opposite the Earth, the planet moves more slowly when it is close to Q and far away from the Earth (you can trace this out for yourself). And it will move faster when it is far away from Q and nearest to the Earth. The equant model thus solves the third component of the Problem of the Planets, variations in speed.

But mathematical modelling was not the only kind of astronomy performed in Alexandria. The greatest observational astronomer in the ancient world was Hipparchus of Nicaea, in the 2<sup>nd</sup>

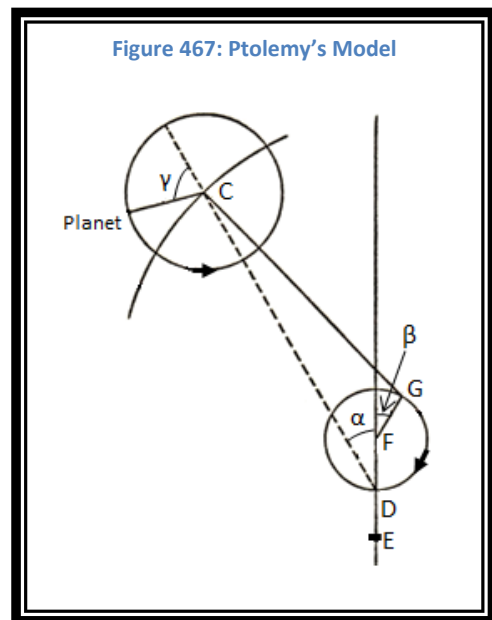
century BCE. By his day, the great Library had accumulated works from the known world, and in its collections were some of the records of the Chaldeans that had passed down to the Assyrians and the Persians. Hipparchus noticed that a few positions for the so-called “fixed” stars had actually moved somewhat over the centuries. Taking his own measurements for the star Spica, and comparing them with older records, he calculated that its position moved about  $1^\circ$  per century. Hipparchus had not only discovered Precession of the Equinoxes, he had also measured it with naked eye observations (the actual rate is closer to  $1^\circ$  every 71.6 years, or 50.3 arc-second per year). He also produced the first reasonably accurate map for stars visible from Alexandria, which included about 850 of the brightest stars (obviously he wasn’t hampered by light pollution).

Finally we come to Claudius Ptolemy, who, at Alexandria around 150 CE, composed his system, the Syntaxis. Ptolemy was not so much an innovator as he was a compiler of everything known in his day. He used all three models developed by Apollonius; he used the observations of Hipparchus; and he followed Plato’s injunction that only uniform circular motion may be employed to solve the Problem of the Planets. Using the best observations available to him, he produced mathematical models for each planet, and then calculated tables from those models for their future positions. The figure here is Ptolemy’s actual model for the planet Mercury.

The Syntaxis also included Aristotle’s mechanical models, and he included what was known about Babylonian and Egyptian astrology. Because he was able to solve the Problem of the Planets and “save the phenomena,” Ptolemy’s system became authoritative, and the high-water mark of ancient astronomy. It would remain unchanged for centuries.

### Toward the Scientific Revolution

Historians of science have described the era in Western thought that marked the transition from Medieval to Modern thought as the Scientific Revolution. A major component of that era was the revolution in astronomy pioneered by Nicolaus Copernicus, Tycho Brahe, Galileo Galilei, Johannes Kepler, and Isaac Newton, in the 16<sup>th</sup> and 17<sup>th</sup> centuries CE. But some mention needs to be made of the period from Claudius Ptolemy in the 2<sup>nd</sup> century until the 16<sup>th</sup> century.



Though Ptolemy worked in Alexandria and wrote in Greek, the entire Mediterranean and much of the Near East, including Egypt, were under the rule of the Latin-speaking Roman Empire. When Ptolemy produced the Syntaxis, about 150 CE, Rome was at its peak. But, in general, educated Romans did not pursue scientific subjects, though a few notable exceptions can be found. Status and rewards went instead to those activities that served the state, like engineering aqueducts, road building, and the design and construction of monumental architecture. Some Romans did value Greek contributions in philosophy, but most Romans valued practical activities, and were a bit suspicious of the foreign ideas of a conquered people.

As the pressures of holding together a far-flung empire began to be felt by the 4<sup>th</sup> century CE, the emperor Constantine removed the capital from Rome to Constantinople (modern-day Istanbul, Turkey) to defend the eastern, Greek-speaking and wealth-generating, half of the empire from northern invaders. The result was the eventual complete split between the eastern and western halves by the 6<sup>th</sup> century CE. The eastern half would continue to flourish until the 15<sup>th</sup> century. But the western, Latin-speaking half, entered that cultural nadir usually referred to as the Dark Ages.

In the East, the Byzantine Empire, which included Alexandria, retained much of the Greek legacy. But as in the West, scholars were discouraged on religious grounds from pursuing and contributing to Greek science. The history of the period after Constantine is rife with religious conflict. The last non-Christian philosopher at Alexandria, the great mathematician and neo-Platonic philosopher Hypatia, was killed by a Christian mob early in the 5<sup>th</sup> Century CE. Thereafter, Alexandria's reputation as a center of learning declined quickly.

Figure 468: Ulugh Beg's Observatory in Samarkand

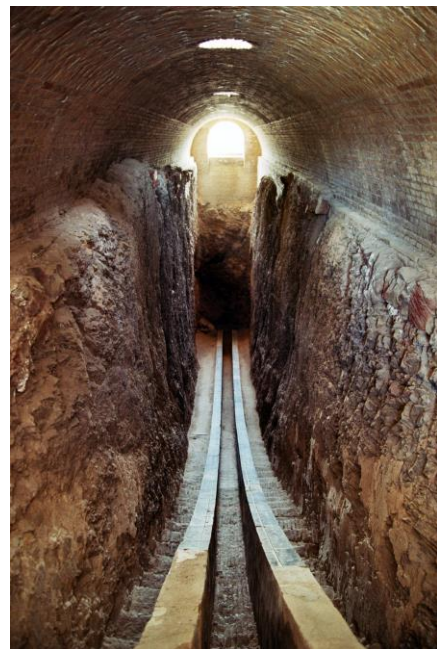


Photo by Igor Pinigin



But this improved version of Ptolemy's astronomy was eventually passed on to the West beginning in the 12<sup>th</sup> century CE and thereafter. (Additional legacies of Arabic astronomy carry over even to the current day, where many star-names are Latinized versions of Arabic names, as are terms like *azimuth* and *zenith*.) The re-acquisition of the Greek legacy was gradual (since the number of translators fluent in both Arabic and Latin was limited), and not without controversy. But in less than two hundred years, Western Europe went through a complete intellectual overhaul. Even the Church was forced to make accommodations, which it did mainly through the work of Thomas Aquinas. The result was that by the early 14<sup>th</sup> century CE, a Christianized version of Plato and Aristotle had become officially sanctioned by the Church. If no conflict with scripture could be detected, then Aristotle's science was the accepted channel for any interpretation of natural phenomena. This meant that geocentrism was the official cosmology of Christian theology, and the Almagest became the accepted model of astronomy in the West.

This table is for the planet Mercury from the Alfonsine Tables (ca. 1275), made at the behest of Alfonso X of Castile. Although Latin had displaced Greek, and Arabic numerals had displaced the Greek notation, Claudius Ptolemy would have been right at home with this table. Despite the translation from Greek to Syriac to Arabic and finally to Latin, no radical changes had been made to his system in over a millennium. So the stage was now set for a young Polish scholar who was just trying to please his uncle, and irritate his father.

### **Nicolaus Copernicus (1473-1543)**

Copernicus (born Mikolaj Kopernik in Torun, Poland) is most remembered for initiating a revolution in astronomy, even though he did not view himself as a revolutionary. On the contrary, his intention seems to have been to revive what he and other Renaissance scholars thought was the true Pythagorean ideal of astronomy, including mathematical and mystical interpretations of that ancient philosophy. In an early draft of his seminal work, De Revolutionibus Orbium Coelestium (*On the Revolutions of the Celestial Spheres*, 1543), Copernicus even made reference to the work of Aristarchus, who we recall introduced the heliocentric system (the final draft of the 1543 edition did not include this reference for reasons unknown). So Copernicus was not a forward thinker – he took his inspiration from an ideal past. This was in keeping with the whole approach of Renaissance Humanism.

Copernicus was about ten years old when his father died and was then adopted by his uncle, Lucas Watzenrode, who was a church official. Uncle Lucas was made Bishop of Warmia in 1489, which conferred significant status and wealth on the household. Realizing his nephew's potential, he sent Copernicus first to the University of Krakow and later to universities in Bologna and Padua, in Italy. By 1503, Copernicus had received degrees in both canon law and

medicine in order to serve as his uncle's private secretary and physician. It is believed that Copernicus underwent minor orders, but did not become an ordained priest. After the death of his uncle in 1512, he was made a canon (an administrator) at Frombork cathedral, a position he occupied for the rest of his life. It was at this time that he first went public, in a small way, with an outline called the Commentariolus, where he introduced his heliocentric astronomy.

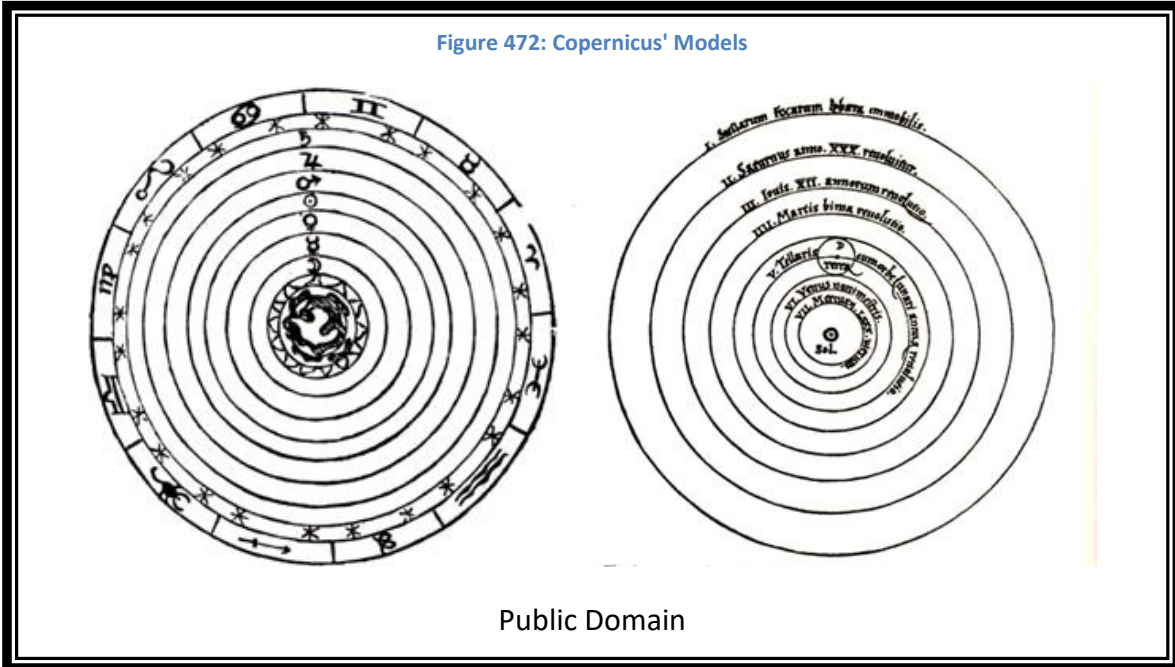
The Commentariolus was only circulated among a handful of friends, but by 1533 it had finally reached Rome, where he was encouraged to enlarge and elaborate his system because of a growing interest in calendar reform by the Church. But Copernicus hesitated, not for fear of accusations of heresy (since the Church was actually encouraging him), but for fear of ridicule. Others before him had offered up new theories, only to be attacked and rejected by scholars and theologians.

This might have been the end of it had not a young Protestant professor at the University of Wittenberg, Georg Rheticus, gotten wind of the theory and personally goaded Copernicus into releasing the full version. The final version was seen through the press by another young Protestant pastor, Andreas Osiander. De Revolutionibus Orbium Coelestium Libri Sex (*Six Books on the Revolution of the Celestial Orbs*) was published in 1543; legend has it that the first printed copy was seen by Copernicus on his death bed. But the 1543 edition was not exactly as he originally intended. Unbeknownst to Copernicus, Osiander included an unsigned preface that stated that the heliocentric system was not to be considered real, but only as a mathematical theory. This may have been a key factor in its not being considered heretical until Galileo defended it seven decades later.

De Revolutionibus was taken seriously by the next generation of mathematicians because of the way in which Copernicus made his case. De Revolutionibus was written, page by page and section by section, in parallel with Ptolemy's Almagest. The next generation of scholars usually studied both systems, literally side-by-side with each other. By 1582, when Pope Gregory XIII called for calendar reform, De Revolutionibus was used for the astronomical portions of that effort.

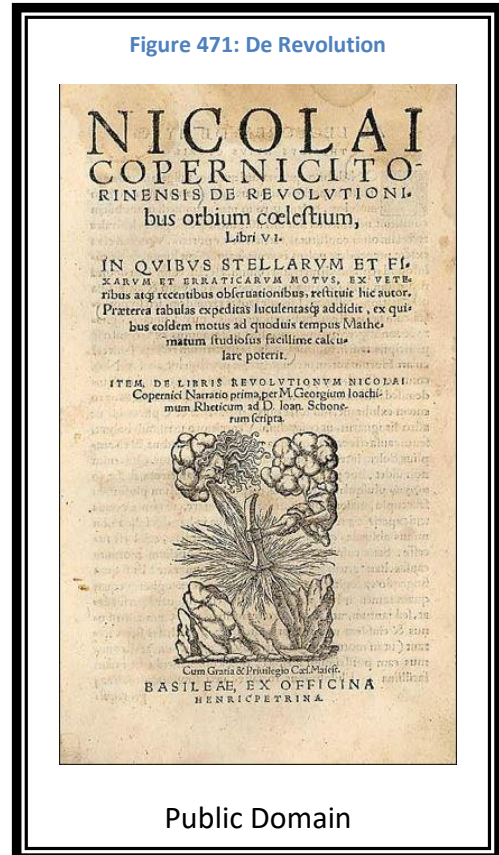
So what arguments did Copernicus make in defense of heliocentrism? Most of his arguments involved the need to re-impose the Pythagorean/Platonic purity that had been degraded, he felt, over the centuries. The equant point, which used equal angles in equal times, clearly did not follow Plato's injunction that only uniform circular motion could be used. Copernicus was able to use combinations of eccentrics with epicycles to eliminate equants.

Copernicus also argued on purely rational grounds that heliocentrism was esthetically more



pleasing, because the order of the planets, starting with Mercury and ending with Saturn, increased their periods of motion around the Sun in increasing order: Mercury completed one revolution in 88 days, while each of the others' orbits took increasingly longer times, ending with Saturn taking nearly 30 years for one revolution. To Copernicus, this increasing time with increasing distance idea resonated very strongly with the Pythagorean Number ideal.

And of course there was the problem of retrograde motion. The heliocentric model made short work of that: the planets did not actually change direction; it was simply an optical illusion created by the fact that the Earth moves, sometimes overtaking and passing the outer planets, and sometimes being overtaken and passed by the inner planets. This may have been his strongest argument. But there were still arguments against heliocentrism, the same arguments that bedeviled Aristarchus: theological tradition, Aristotle's physics, and the lack of stellar parallax. Osiander's preface, however, made these arguments moot. If De Revolutionibus was just a mathematical tool, and not



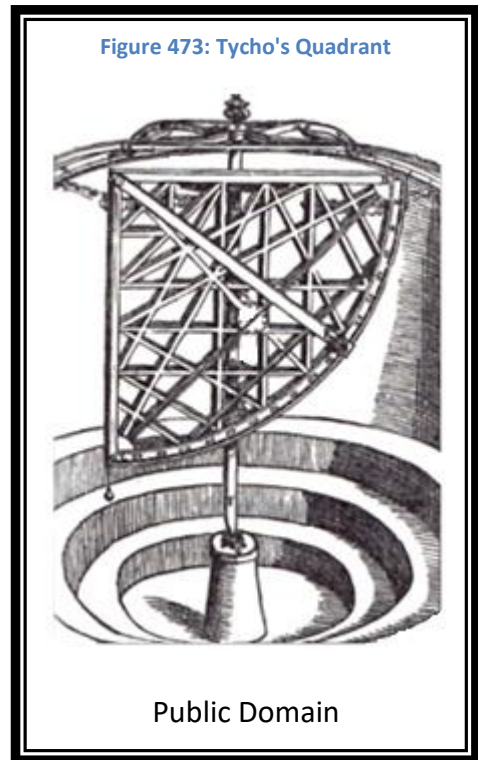


the model for a real system, then it didn't matter whether heliocentrism was real or not. What did matter is that the new system was easier to use, and, with more up-to-date observations, it was more accurate.

So Copernicus' worries about ridicule were unfounded. Over the next two generations, perhaps only about two dozen scholars mastered his system, and the Church, even during this period of the Counter-Reformation, found no reason to suppress it, or even to consider it controversial in any way. That remained for a later generation of scholars who depended more on actual observations, and combined these with new arguments for a revision of astronomy.

### **Problems with Aristotle's World-View**

Tycho Brahe (1546-1601), was born into the Danish nobility. His early interest in astronomy was natural, since he had no astronomy teachers, and his father actively suppressed Tycho's interest since astronomy had no bearing on the father's plans for Tycho's future as a statesman. He wanted Tycho to study law, and just forget about this astronomy silliness.



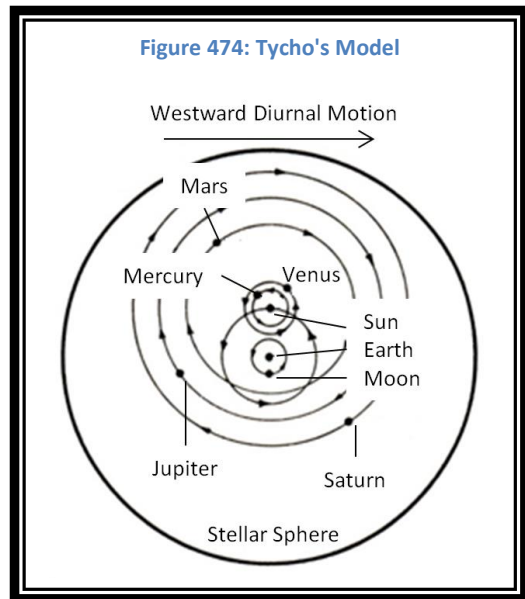
Tycho's early interest in astronomy seems to have been two-fold: he truly enjoyed observing the heavens, and he developed a life-long interest in astrology and prognostication. A solar eclipse on August 21, 1560, occurred just as predicted by both the Almagest and De Revolutionibus. The fact that celestial events could be predicted at all amazed the teenage boy. But three years later, when a predicted conjunction of Jupiter and Saturn was off by a month in the Almagest, and off by a day in De Revolutionibus, Tycho was totally unimpressed. Clearly, more and better observations were needed if astronomy (and the predictions of astrology) were to be valid.

Tycho's father kept up the pressure, though, to give up astronomy in favor of more practical pursuits. He might have won had not the supernova of 1572 intervened. Tycho made multiple observations and kept scrupulous records over the 18 months it remained visible. When he compared his observations with others from across Europe, he was able to conclude that the "new star" did not occur in the sub-lunary realm where Aristotle stated that all ephemeral phenomena must occur (since beyond the Moon the heavens were unchangeable and perfect). Tycho published his results in De Nova Stella (*On the New Star*) in 1573, making Tycho known

throughout Europe. The Danish King, Frederick II, decided that Tycho need not choose between statesmanship and astronomy: he awarded the island of Hveen off the Baltic coast of Denmark for Tycho to rule, and to establish an observatory funded by the king himself.

Needless to say, Tycho immediately accepted the offer, and began construction of his observatory, Uraniborg. It became the premier naked-eye observatory in Europe, where Tycho lived and worked until 1597, when Frederick's successor cut off funding. During that period, Tycho assiduously performed thousands of observations with a large mural quadrant which was accurate to about 2' of arc. He also observed the great Comet of 1577, and again demonstrated that it could not have been in the sub-lunary realm; indeed, it must have cut through the orbits of several planets, which meant that Aristotle's model of crystalline spheres must be wrong. The path he calculated for the comet was the first known instance of non-circular motion attributed to a celestial body.

After 1597, Tycho wandered around Europe, cutting a swathe through upper society, and gaining a reputation for his quick temper and prodigious ability to party. Back in his university days he got into a duel and had a major chunk of his nose sliced off. So Tycho brazenly manufactured a metal nose (in fact he made several, of different colors and materials, so he would always be the center of attention). By the time he arrived at the court of the Holy Roman Emperor, Rudolph II, in Prague, Tycho's reputation had preceded him. Rudolph loved collecting interesting people and loved to entertain, so they seemed made for each other. Tycho was anxious to find a patron to pay to have his decades of observations published, and Rudolph agreed; but they would have to be converted into usable tables, and they would have to be a major upgrade to the antiquated Alphonsine Tables still in use throughout Europe. Tycho immediately accepted and agreed that they would be called the Rudolphine Tables. Thereupon he hired the best mathematician he could find to make the laborious calculations, a fellow by the name of Johannes Kepler.



Tycho and Kepler had an uneasy working relationship. Tycho the Danish noble seemed more interested in partying than work, and was very secretive with his data. Kepler, on the other hand, was a sober and hardworking Protestant commoner. But more fundamentally, Kepler did not agree with Tycho's solution to the Problem of the Planets.

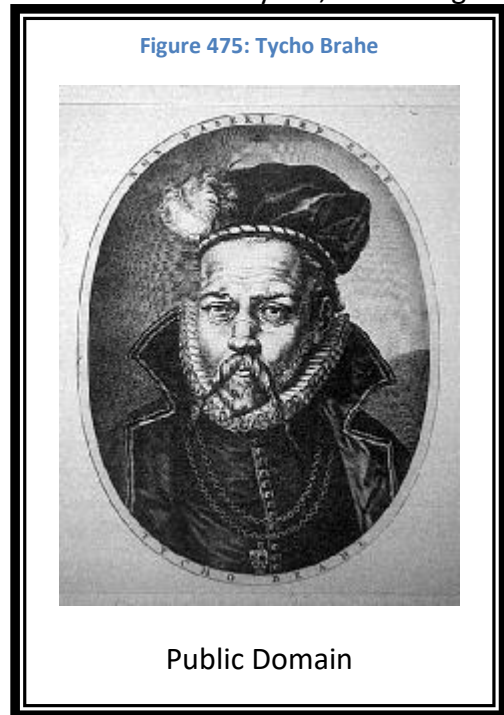
Tycho's system was a hybrid of the Ptolemaic and Copernican models, which historians now call the "geo-heliocentric" system. The Earth is still unmoving at the center of the cosmos, and the Sun and Moon both revolve around the Earth. But Tycho put the planets in orbit around the Sun, not around the Earth. The advantages of this system are that there are no conflicts with religious tradition or Aristotle's physics, and of course an unmoving Earth would not predict stellar parallax. But the problem of retrograde motion is also explained as an optical illusion as in the Copernican model. Indeed, the Tychonic model is just as accurate as the Copernican model, since they are mathematically equivalent (try erasing the orbit for the Sun around the Earth and then drawing an orbit for the Earth around the Sun: you have just converted Tycho's system into Copernicus' system).

But Kepler disagreed with Tycho. Kepler was totally convinced that heliocentrism was the true model of the heavens based on mystical Pythagorean principles of symmetry and beauty. Besides, Tycho's model would have the orbit of the Sun cross the orbit of Mars: how was that supposed to work? Kepler was glad to be working with the best data in existence, but he hated that it was being used to support the Tychonic model. This all ended when Tycho, after a night of drinking and feasting, died of a burst bladder in October, 1601. After wrangling with Tycho's widow, Kepler finally inherited Tycho's data.

### **Kepler's War on Mars**

Johannes Kepler (1571-1630) was the son of a soldier-of-fortune whom he barely knew, and a mother who owned a small property that would be the source of her sorrow. Young Johannes showed early promise in school, and managed to win a scholarship to the University of Tübingen, in modern-day southwestern Germany. There he met Michael Maestlin, an astronomer and mathematician, who introduced Kepler to Copernican astronomy, Pythagorean mysticism, and astrology. Kepler was there ostensibly to study theology, and although he always considered himself to

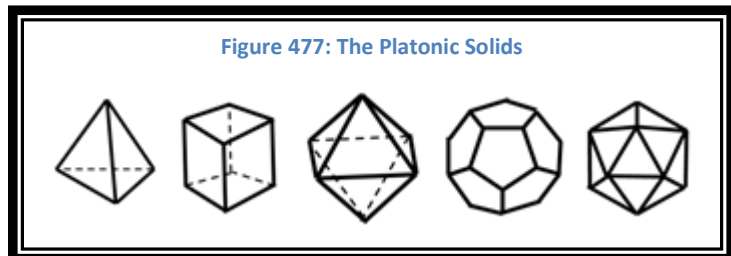
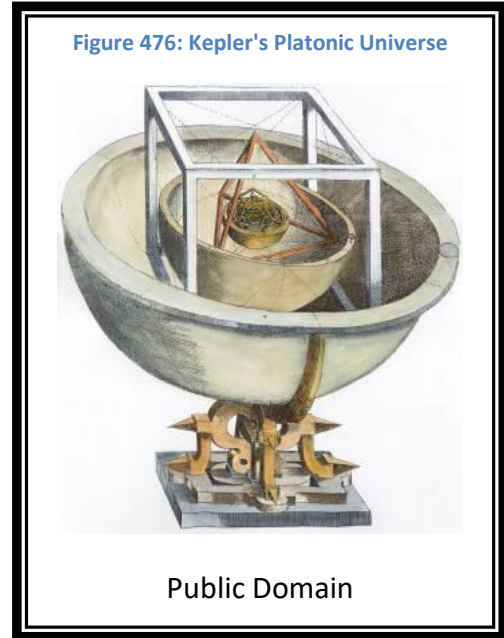
be a good Protestant, he could never adhere to every dogma or doctrine of either the Lutheran or Calvinist sects. This would be the source of lifelong frictions and conflicts with theologians and civil authorities. And it didn't help that he was friendly with other mathematicians, some of whom were Catholic, or, even worse, the despised Jesuits.



Kepler's first published work, Mysterium Cosmographicum (*The Cosmographic Mystery*, 1596), was a defense of Copernican heliocentrism based entirely on mystical Pythagorean arguments. A famous example: Why are there just six, and only six, planets? Answer: Because there are exactly five, and only five, Platonic Solids. The diagram shows the five Platonic Solids: the tetrahedron, octahedron, icosahedron, the cube, and the dodecahedron. The Pythagoreans had proved that there could be no sixth perfect solid, that is, a solid where every facet is either an equilateral triangle, square, or pentagon. For Kepler, this kind of perfection must be mirrored in the heavens, so he produced a model based on this notion. This

diagram is from the Mysterium Cosmographicum showing how spaces between the six planets are filled with the five Platonic Solids. Each sphere (here shown as half-spheres so you can see inside) carries a planet, and between each sphere is a Platonic Solid nested between them. This is typical mystical Pythagorean reasoning, and Kepler's 1596 book is loaded with it. (Kepler sent a copy to Galileo, who wrote back a pleasant, but nevertheless, noncommittal reply.) However, the Mysterium Cosmographicum was popular in scholarly circles, and Kepler became known to an international audience.

Kepler was aware of Tycho Brahe's reputation as a keen observer, and heard that he needed help with reducing his observational data for the Rudolphine Tables. Because of a property dispute with one of her neighbors, Kepler's mother was accused by the neighbor of witchcraft. The charges were pursued because the neighbor cut a deal with the local magistrate; this meant that Kepler himself was forced to commit his limited resources to her defense, which dragged on for several years, due largely to Kepler's dubious standing with the local clergy. So the opportunity to work with Tycho was timely, and saved the magistrate the trouble of expelling him. He arrived in Prague in the autumn of 1600.



After the death of Tycho in 1601 and the acquisition of the data, Kepler took up the task of devising the Rudolphine Tables as court mathematician to Rudolph. But Kepler had more important items on his personal agenda, so the Tables weren't published until 1627. He had no intention of defending Tycho's geo-heliocentrism.

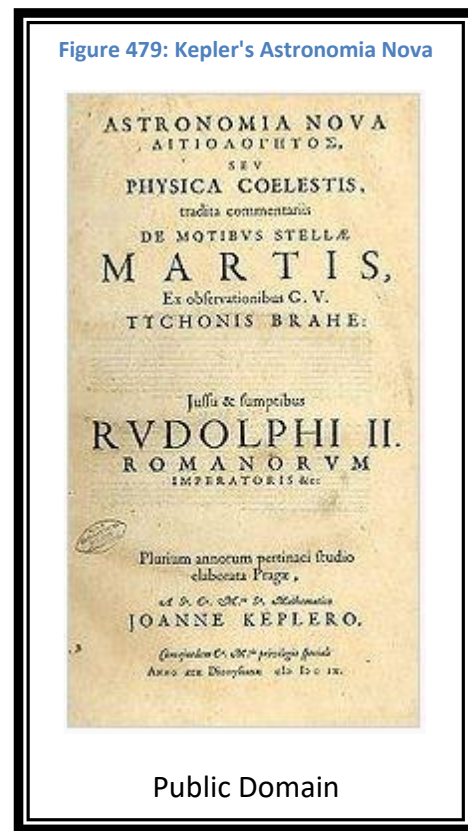
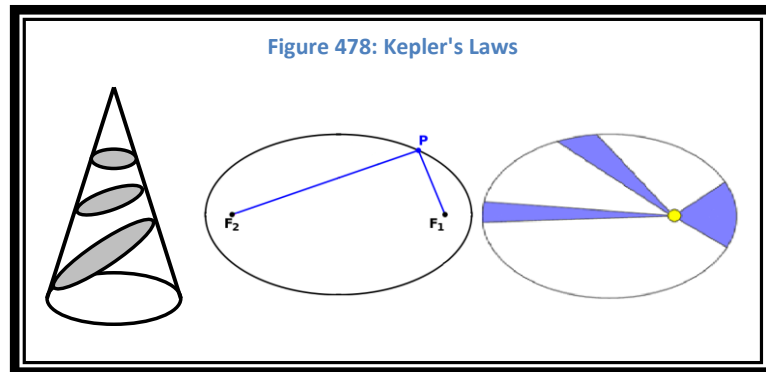
The chief defining factor in Kepler's success was not his mathematical ability or his astrological and mystical predilections. It was, rather, his complete faith in Tycho's data and his incredible persistence that served him best. Between 1601 and 1609, when his work *Astronomia Nova* (*New Astronomy*) was published, Kepler tried many possible solutions to the

Problem of the Planets – but in particular to one planet, Mars.

Mars' orbit is more eccentric than the other planets, except for Mercury, and getting accurate observations of Mercury was notoriously difficult due to its nearness to the Sun. And Tycho had taken many observations of

Mars at many different positions in its orbit. For Kepler, Mars was a perfect target.

Kepler also knew just how accurate Tycho's observations were. Many times Kepler would work out a solution that was off by only a few minutes of arc; but because he knew the data were accurate to less than two minutes of arc, Kepler would reject that attempt and try again. He describes in *Astronomia Nova* how one promising series of calculations, (which he was forced to carry out by hand and had to be continuously revised as small errors crept in), after two full years had to be scrapped because it failed to live up to Tycho's data. Mars, the Roman god of war, was living up to his reputation, and Kepler even called his long mathematical assault his "War on Mars." But finally he struck on a solution that fit the data, and it didn't involve uniform circular motion after all. Mars moves in an ellipse. In fact, all the planets move in ellipses, with the Sun at one focus. This finding is now known as



### Kepler's First Law.

This wasn't the only result of eight years of labor. The Astronomia Nova also contains Kepler's Second Law: as the planets travel their elliptical paths and as they are viewed from the Sun's vantage point, they sweep out equal areas in equal times.

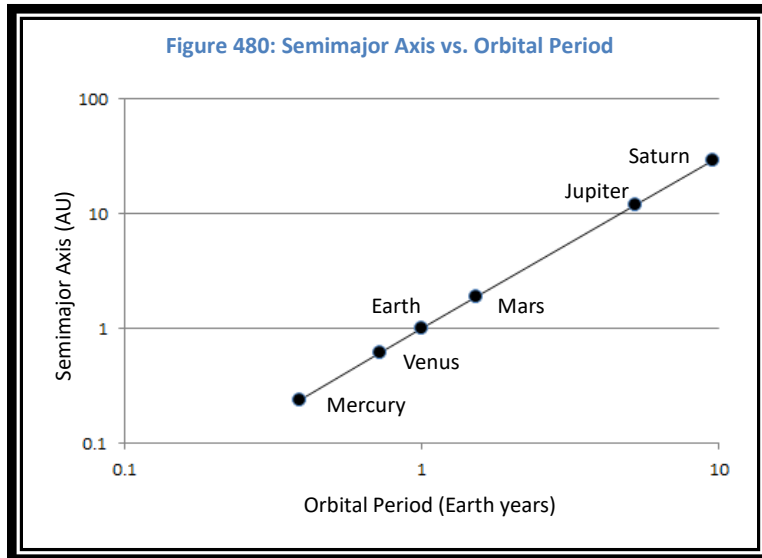
The diagram shows how an ellipse is generated (first figure),

the two foci of an ellipse (second figure), and Kepler's Second Law (third figure). An ellipse is generated when a plane intersects a right circular cone: if a plane slices the cone at right angles, it produces a circle; if it slices at an angle, it produces an ellipse; the steeper the angle, the more eccentric the ellipse. The second figure shows the two foci ( $F_1$  and  $F_2$ ) of the ellipse, and for planet P the Sun will always occupy one of the two foci. The third figure shows how a planet P at three different parts of its orbit always sweeps out equal shaded areas when the times between the measurements at P and P' are equal and the areas are measured from the Sun at one focus at S.

These results from the Astronomia Nova are, from our point of view, its key scientific findings. But if you actually read this work, you may be baffled by all the findings that have no scientific value. It is still loaded with mystical Pythagorean musings. You have to search the book closely to find the two Laws. Kepler sent one copy to Galileo, who again responded politely, but privately did not believe in ellipses or anything else in the book. (Contrast this with Kepler's response to Galileo's 1610 best seller, Siderius Nuncius, where he was positively effusive in his praise.)

Another decade would pass before Kepler produces his last major work, Harmonices Mundi (*Harmonies of the World*, 1619).

This book was written with much of the same mystical speculation as his other works, as the title implies. He spent much of his time trying to determine that the orbital distances of the planets were in whole number ratios to each other, and that these ratios corresponded to musical notes, chords, and harmonies. This is classic Pythagoreanism, as it was Pythagoras himself who discovered the same thing for the mathematical ratios of the lengths of plucked



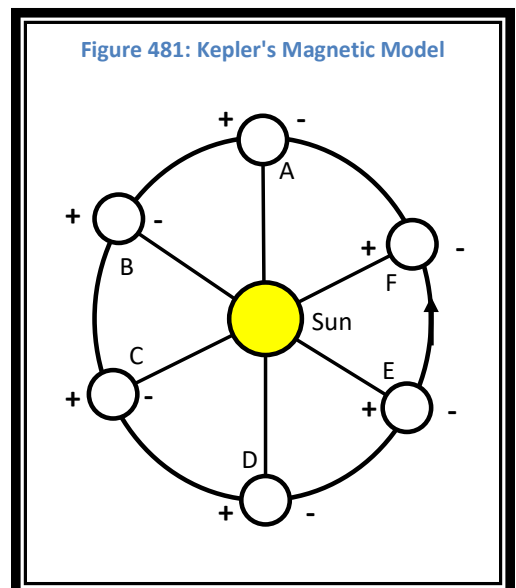
strings and their corresponding musical tones. But buried deep inside the Harmonices Mundi lies Kepler's Third Law: for any planet, the ratio of the square of its orbital period to the cube of its mean distance from the Sun is a constant. In the diagram, the straight line relationship demonstrates how the ratio is the same for each planet. The formula  $a=P^{2/3}$  uses the modern notation for the distance,  $a$ , and the period,  $P$ . (You can cube both sides to get:  $a^3=P^2$  which is closer to how Kepler stated it, and is sometimes called the cube-square law.) Kepler's Third Law is correct, but the reasoning behind it is totally mystical. Again, it is Tycho's data that is the key ingredient, and Kepler's faith in the data was total.

Kepler's last contribution (from a scientific point of view) was his recognition that elliptical motion could not arise in any kind of model that employed crystalline spheres. Since all the planets orbited the Sun in the Copernican system, Kepler assumed that the Sun must exert a force of attraction on the planets. Having read a work on magnets by an English natural philosopher, William Gilbert (De Magnete, published in 1600), Kepler decided that the Sun exerted a magnetic force of attraction that caused the planets to move in ellipses. In this diagram, the Sun's surface is one magnetic pole while its center is the other magnetic pole. Each planet also has a set of magnetic poles, which are attracted to the Sun's surface at points B to C, and are magnetically repelled at points E to F (at points D and A the forces are equal and cancel each other). This accounts for the changes in speed, and the elliptical orbit, of the planet.

Johannes Kepler died in 1630, just three years after publication of the Rudolphine Tables. Due to the accuracy of Tycho's data, the Tables were a major improvement over any others, so they were quickly adopted by astronomers throughout Europe. And because Kepler propounded the Copernican cosmology throughout, the Rudolphine Tables was the single most influential factor in the gradual acceptance of heliocentrism in the 17<sup>th</sup> century CE. But that acceptance was gradual, and confined mainly to Protestant northern Europe. Catholic southern Europe still defended an unmoving Earth, and the scholarly arm of the Church, the Jesuits, stolidly defended Tycho's geoheliocentrism over all challengers.

### **Galileo and the Church**

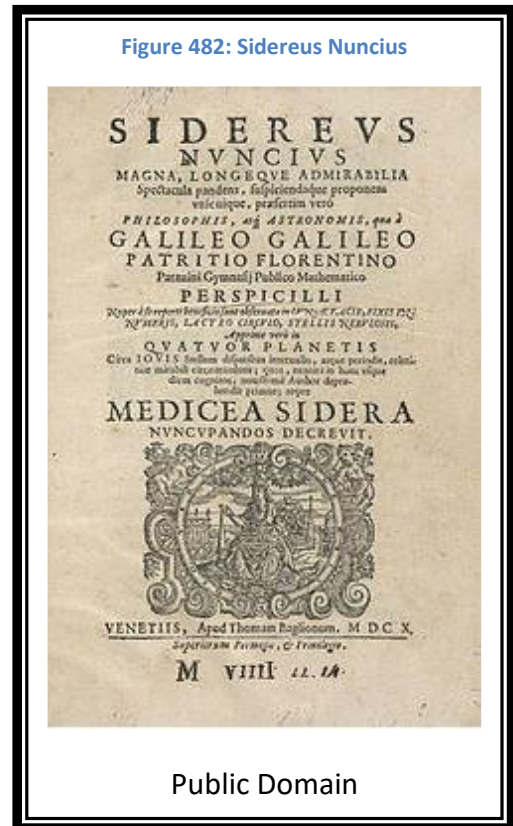
Galileo Galilei (1564-1642) is probably the best known of all the Renaissance astronomers. His contributions to observational astronomy and to the analysis of terrestrial physics were a turning point in the Scientific Revolution. But his fame rests largely on his



defense of Copernicus in the face of religious objections, where his personal demise is usually cast as a scientific martyrdom.

Galileo was born in 1564 in Pisa, Italy, to a father who was well educated, a respected cloth merchant, and somewhat of an authority in musical theory. The father wanted his son to study medicine, but Galileo early on got hooked by mathematics. By age 25, he had become head of the mathematics department at the University of Pisa. But his father did not approve, since mathematicians were held in low regard, and the salary was quite low.

One of Galileo's character faults manifested itself during this early part of his career: when arguing forcefully, his disdain for anyone who disagreed with him created enemies. His attitude seemed to be that everyone should acknowledge him as the "smartest guy in the room," and if that didn't happen, Galileo was very good at belittling any holdouts. He was particularly disdainful of anyone who defended Aristotle's theory of falling bodies, which he felt he had completely disproven. Galileo's analysis was, of course, the first step toward modern physics. But it was in Galileo's nature to offend nearly everyone while taking that step. His position became untenable, and he was forced to go elsewhere. He got a similar position at the University of Padua, which was part of the Venetian Republic, where he taught mathematics from 1592-1610. It was during this period that he completed his revision of terrestrial physics, including Galilean Relativity and the concept of inertia. But he chafed under the demands of teaching when he wanted to pursue his own interests.



The course of his career suddenly changed when he got word that the Venetian ambassador to Holland had recently returned with a new toy invented by Dutch spectacle-makers, a spyglass. Galileo quickly understood its principles and set out to build his own, improved version. This he did in 1609, and during the winter of 1609-10 made the first recorded telescopic observations of the night sky, and publicized them in the Sidereus Nuncius (*The Starry Messenger*, 1610). The book was instantly popular and went through additional printings, the Renaissance version of a bestseller. Galileo set up a workshop and hired artisans to build telescopes, which became a lucrative side business, because suddenly everybody wanted one. He even had one built for the Doge of Venice, who was intrigued by its potential for national defense.



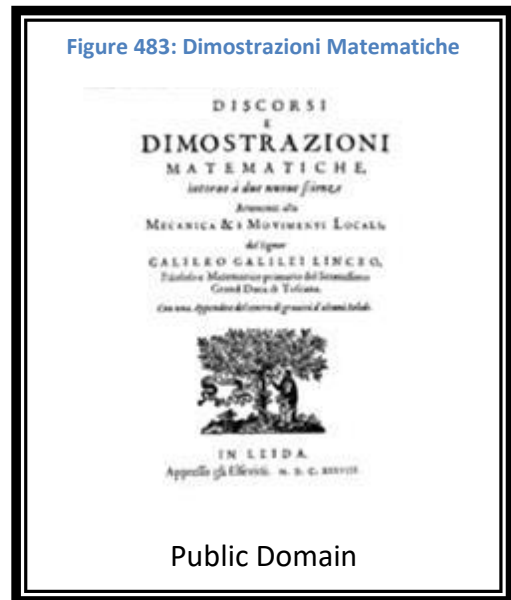
Within a year Galileo's observations were confirmed by a number of observers, including the renowned Jesuit mathematician, Christopher Clavius, in Rome. Galileo was invited to Rome and enjoyed celebrity status. He was received and recognized by Pope Paul V. The Jesuits even published a Chinese version at Peking in 1616. But while everyone agreed on what Galileo observed, conflict arose when he used his observations to support heliocentrism. He got into arguments, and, again, his personality began to create enemies; his greatest allies, the Jesuits, over time, became his greatest opponents.

So what did Galileo observe and what interpretations caused so much trouble? Under the telescope, the Moon was revealed to have Earthlike features, including mountains and valleys. The surface of the Sun was not the pristine orb lauded from earliest antiquity; instead it had black spots that moved across

its face. The Milky Way was actually composed of thousands of faint stars. Jupiter had "stars" of its own, that were clearly in motion around the much larger planet. And the planet Venus went through phases, much like the Moon did, which would clearly be impossible in the Ptolemaic geocentric system.

So Galileo had observations that repudiated the old cosmology instituted by Aristotle. But Tycho Brahe had also revealed problems with Aristotle's system with his observations of the supernova and the comet, yet did not support heliocentrism. The phases of Venus, which are devastating to geocentrism, are quite adequately dealt with in Tycho's geo-heliocentrism, and it has an unmoving Earth at the center. It is perhaps only natural, then, that the Jesuits championed Tycho's model over the Copernican model, since religious tradition calls for an unmoving Earth.

Galileo resorted to rhetorical ploys, hoping to shape the ongoing argument in terms of his choosing. He never addressed Tycho's system at all; he always made his case by contrasting geocentrism with heliocentrism. And he began to venture into the realm of theology by questioning whether the Bible could or should be used as a source for scientific argument: "the Bible tells us how to go to heaven, not how the heavens go." Making these arguments in a public letter to the Grand Duchess Christina of Tuscany, in 1615, brought the situation to a head. It was one thing to dispute among scholars; it was something else entirely when expressed in public. The Holy Office began an official investigation by the Congregation of the Index, and in early 1616, De Revolutionibus, which had been taught and published for 73 years,

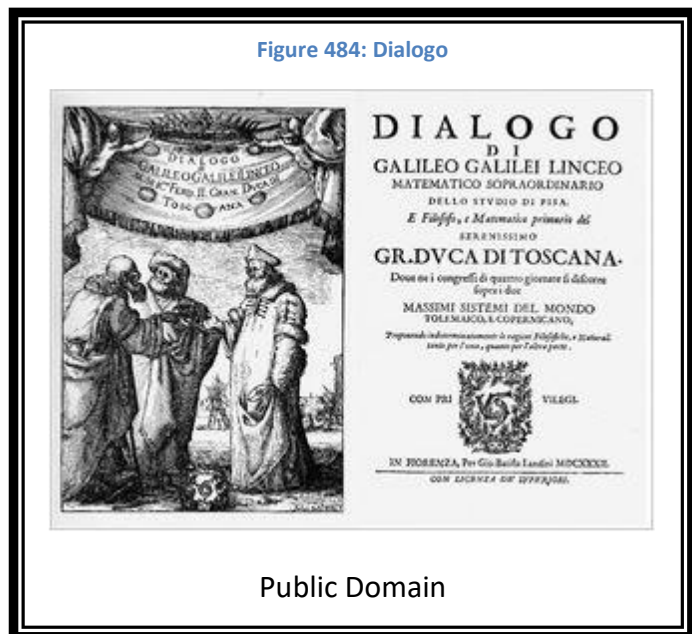


was placed on the Index of proscribed works until it could be “corrected.” And Galileo was informed that he could not hold or defend heliocentrism, since a moving Earth was “foolish, absurd, and heretical.”

This wasn’t the end of it, however. One prelate, Cardinal Maffeo Barberini, was a supporter of Galileo, even at one point writing a poem celebrating him. He told Galileo it would be acceptable to discuss heliocentrism if he made it clear that it was only a hypothesis. In 1623, this same Cardinal Barberini was elected Pope Urban VIII, and Galileo chose to take advantage of the new situation. He published a book, Il Saggiatore (*The Assayer*, 1623), that supported the ancient idea of atomism, which some Church scholars interpreted as an attack on the dogma of Transubstantiation. But the new pope, who was not a patron of the Jesuits, would not allow any attacks on his great friend.

Emboldened even further, Galileo went on to publish the work that eventually proved to be his downfall, Dialogo...sopra i due massimi sistemi del mondo... (*Dialog on the Two Chief World Systems*, 1632), which was written in Italian to assure a wide public readership. The Dialogo has three characters that spend four days discussing philosophical issues, in particular, the Ptolemaic and Copernican systems. One of the three represents Galileo, who defends Copernicus; another represents an intelligent layman; and the third represents a simple-minded defender of Ptolemy and Aristotle. The Jesuits cleverly compared the opinions of Simplicio, the simpleton, with statements that had been made by the Pope, making it appear that Galileo was publicly ridiculing him. The Pope was completely turned around and allowed charges to be brought forward by the Inquisition.

Ultimately, Galileo was convicted of “grave suspicion of heresy” and not heresy itself, in 1633. A conviction for heresy would have meant that Galileo would have undergone torture, and then he would have been burned at the stake. Instead, he was shown the instruments of torture, after which, as a good Catholic, he recanted. His crime was failing to obey the 1616 order not to hold or defend heliocentrism, for which he was sentenced to house arrest until his death in 1642. The key point is that Galileo did not have the proof he needed to win the scientific argument,



since stellar parallax was not observable even with his new telescope. And by venturing into theology he really had no chance to win that kind of turf war. His ability to create enemies at every turn was also certainly a factor.

But even house arrest and the onset of blindness could not completely deter him. Discorsi e Dimonstrazioni Matematiche Intorno a Due Nuove Scienze (*Discourses and Mathematical Demonstrations on Two New Sciences*, 1638) was smuggled out of Italy and published in Leiden, South Holland. This was Galileo's last book, and it was a summation of all his work on terrestrial physics. It was this work that had the greatest impact on Isaac Newton. It was Newton who finally put Kepler's astronomy together with Galileo's physics to complete the Scientific Revolution.

### **Newton's Solution to the Problem of the Planets**

Isaac Newton (1642-1727) was born on Christmas Day, 1642. His father died before he was born, so he was raised on a farm owned by his mother in rural England. His childhood was not a happy one, because his mother re-married and the young Isaac never accepted his stepfather. Early on it became clear that Isaac had a talent for schoolwork and was a disaster at farm-work. He entered Cambridge University in 1661 as a subsizar, a kind of work-study servant to older, wealthier students. The curriculum still emphasized Aristotle, but Newton read widely outside of the required subjects. Within four years, this self-directed course of study led him to become the most advanced mathematician in the world.

Newton is a fascinating figure for historians of science, because there are many facets to his life and work, not all of which are explicable in the light of modern science. In addition to the invention of calculus and the Newtonian reflector telescope, not to mention the codifying of the three Laws of Motion and the first studies in spectroscopy, Sir Isaac was also a lifelong alchemist and heterodox Bible interpreter. Indeed, in his later years he considered his scientific work mere diversions from his more important theological speculations, and he always considered his work in alchemy as by far the most important of his practical pursuits. Scientific tradition still sees Newton as the first true scientist, when it would be more accurate to describe him as the last true alchemist.

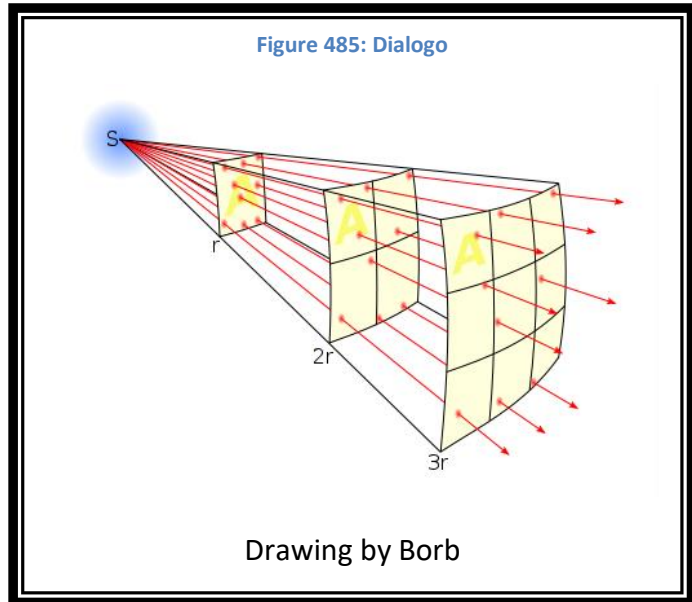
Nevertheless, Newton's solution to the Problem of the Planets is the one that has come down to our day. He recognized that Galileo's concept of inertia was the key to overthrowing Aristotle's objections to an Earth that rotates on its axis. Galileo described how he observed a ship sailing slowly through a harbor, its motion determined by reference to the background of other ships, piers and buildings. As it sailed past, a sailor dropped an object from the top of a mast, and struck the deck at the foot of the mast. From the point of view of the sailor, the

object fell straight down. But from Galileo's point of view against the background of the harbor, the object moved in a curve, because the object moved forward with the same speed and direction as the moving ship while it was dropping. For Newton, all objects on the spinning surface of the Earth carry the same speed and direction as the spinning Earth. An object dropped from a tower does not land to the west because that object is carried to the east like everything else, including the tower. So the object lands at the base of the tower just like that object dropped from the mast of the moving ship hits the foot of the mast. This tendency to keep moving illustrates the concept of inertia: objects will maintain a state of rest or of constant motion unless acted upon by an external force. This is Newton's First Law of Motion.

The analysis Galileo provided for falling bodies and inertia appeared in his Two New Sciences. By looking at the problem of the ship in the harbor from two

different points of view, that of the sailor and that of Galileo on shore, this is the basis for Galilean Relativity. Newton went on to generalize the analysis of problems in physics by using the idea of the Reference Frame, because what you observe and how you conduct measurements only have meaning when you take fully into account your frame of reference. This is where Aristotle got it wrong and Galileo got it right.

From Kepler, Newton recognized that for planets to move in elliptical orbits, some force must be acting on them. (Otherwise, from the First Law, planets would travel in straight lines.) By the 1660's, a number of natural philosophers had speculated that such a force would be an inverse square force, meaning that the strength of the force would decline as you got farther away as the square of the distance from the source. This idea flows naturally from simple geometry: anything that radiates from a central source in 3-dimensional space does so as an expanding sphere of influence. A given amount will thus spread out over the surface of that sphere, and as time passes and the sphere gets larger, the amount of that initial influence spreads out and gets less intense. Since the surface area of the sphere, from elementary geometry, is  $A = 4\pi r^2$ , the force decreases as the distance increases, and the rate at which that initial influence decreases is related to the square of the radius of the sphere,  $r$ . This is the definition of an inverse-square force.



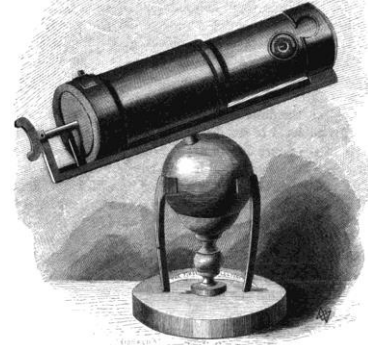
So the idea of an inverse square force was bandied about, but the question was, can you actually prove that Kepler's Laws must obey an inverse-square force? This was the question that astronomer Edmond Halley (of Halley's Comet fame) put before Isaac Newton in 1684. This question was the inspiration for Philosophiae Naturalis Principia Mathematica (*Mathematical Principles of Natural Philosophy*, 1687), the culminating work of the Scientific Revolution.

Halley was 14 years younger than Newton, and had been a member of the Royal Society of London for Improvement

of Natural Knowledge since 1678. This was several years after Newton had distanced himself from the Royal Society and its members because of a dispute over his theory of colors, which he submitted as a letter to them early in 1672. Just one month before, members of the Royal Society first became aware of Isaac Newton because of his telescope. This is a drawing made in London after they first used it. (Newton's reflector is about 6 inches long.) Needless to say, the new telescope was a sensation, and Newton went from being an obscure Cambridge scholar to an internationally known natural philosopher. But the theory of colors, based on his work with a prism and the refraction of sunlight, met with considerable resistance.

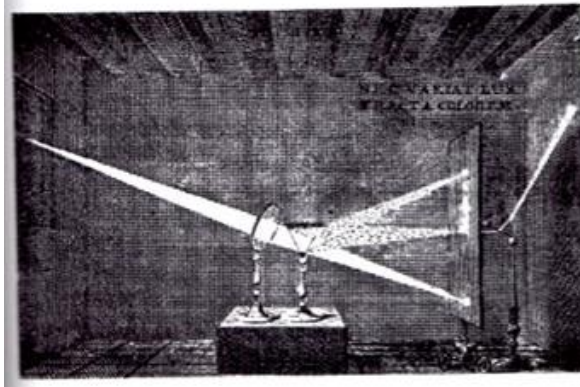
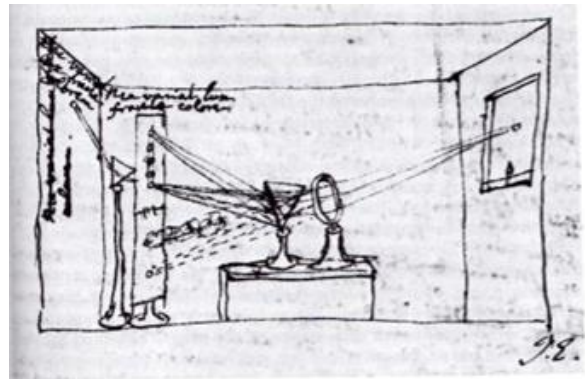
From 1665 until his coming out in 1672, Newton's work in mathematics and optics was known only to a handful of scholars in Cambridge, the most important of which was the Lucasian Professor of Mathematics, Isaac Barrow. Barrow had done important work in both subjects, but quickly realized that Newton

Figure 486: Newton's Telescope



Drawing by David Brewster

Figure 487: Newton's Spectrum



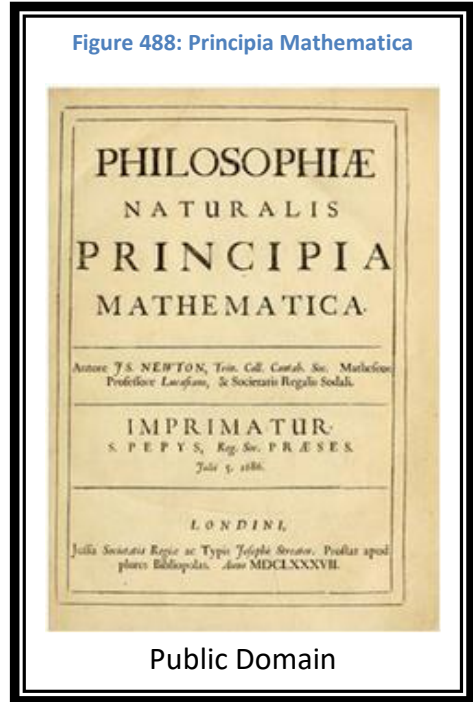
Public Domain

had gone well past him. When Barrow was offered the position of Chaplain to the King in 1669, he nominated as his replacement the obscure and secretive Isaac Newton. (The current Lucasian Professor is Sir Stephen Hawking.)

He built his telescope that same year, but was timid in going public. Not until late 1671 did he allow anyone outside of Cambridge to see it or talk about it, but he gradually warmed to the universal praise it received. But when he sent in the letter to the Royal Society in which he showed that white light is an amalgam of colored light, and that the individual colors themselves could not be refined any further, he met with many objections. His response was to withdraw again, and he would remain out of the limelight until Halley approached him in 1684.

$$F = G \frac{m_1 m_2}{r^2}$$

Cambridge to it, but he gradually warmed to the universal



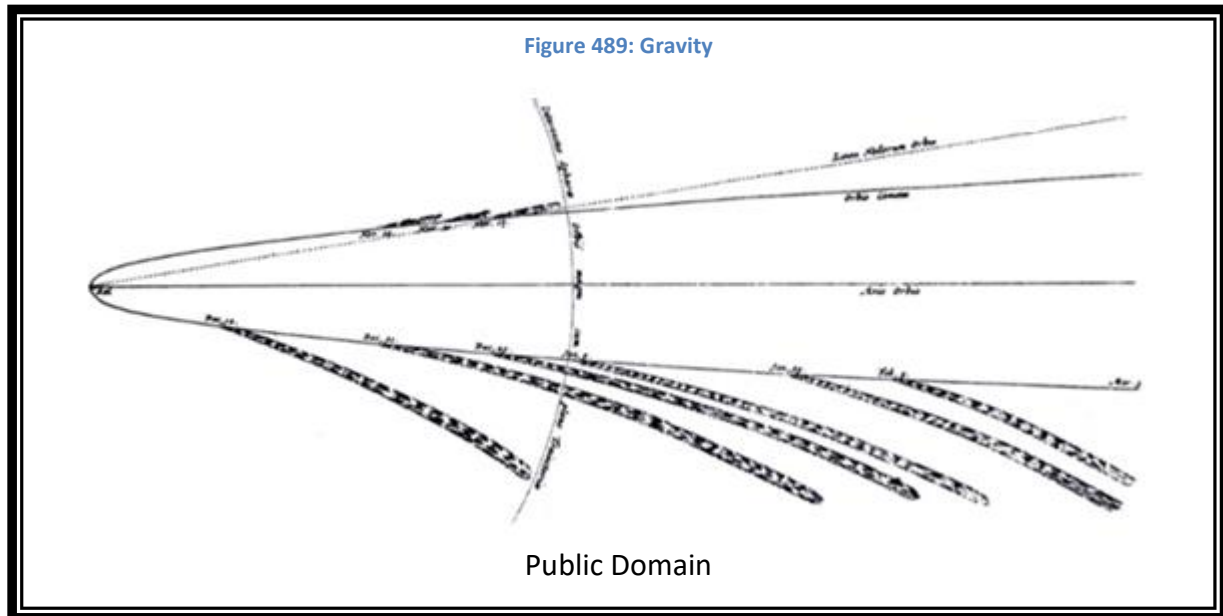
Public Domain

Figure 553 shows Newton's own sketch of his apparatus and the bottom version shows how it appeared in the second French edition of his *Optique* (*Optics*, 1722). The printed version is reversed, but they show the same setup: sunlight enters at the left, passes through a lens and then passes through a prism. Some of the light continues down to the right, the rest is refracted and appears as a vertical band of colors, a spectrum, on the screen at the right. The screen itself has a hole through which one of the colors is allowed to pass and is refracted through a second prism behind the screen. That light hits the wall at the upper right, and is still the same color, proving that the colored light is primary, while sunlight is not. This scientific study of spectra launched by Newton in the *Optics* marked the beginning of a new analytical technique, spectroscopy, which would prove invaluable for physics, chemistry and astronomy.

The dozen years between the letter on optics and Halley's overture in 1684 Newton spent on alchemy and unorthodox theology. But Halley's question stirred him to reconsider scientific problems. What started out as a fairly simple monograph blossomed into a full-blown book, with axioms, postulates, and proofs, dealing with everything from terrestrial motion to planetary astronomy. The key finding was his proof that Galileo's analysis of falling bodies due to gravity applies to all bodies, including the planets.

The law of gravity, where  $m_1$  and  $m_2$  are the masses of two bodies,  $r$  is the distance between them, and  $G$  is a constant, gives the force due to gravity. Since the force law applied to any two bodies, it was universal. The same physical laws that applied to objects here on the Earth also

applied to objects in the heavens. The ancient precept that held that the sub-lunary realm was the region of all ephemeral impurity, and that the heavens were eternally perfect, was finally



dealt a death blow. (This is Newton's analysis of the great comet of 1680-1 in the 1687 edition of the Principia.)

Not all natural philosophers, however, accepted Newton's interpretation of the law of gravity as an attraction-at-a-distance force, because Newton did not explain just how gravity was supposed to work. The reigning scientific philosophy of the 17<sup>th</sup> and 18<sup>th</sup> centuries required that actual mechanical models must be used in any explanation of natural phenomena, and Newton did not do that. To men like Christiaan Huygens and Gottfried Wilhelm Leibniz, it seemed that Newton was trying to introduce mystical influences into natural philosophy. But on the whole, the Principia made Newton famous, and its principles were adopted well outside the field of natural philosophy. It would take several generations for science, philosophy, government, literature, art, religion, and all other institutions in Western society to digest the full implications of universal scientific laws. But in the end, the Scientific Revolution proved to be, in the widest sense, truly revolutionary.

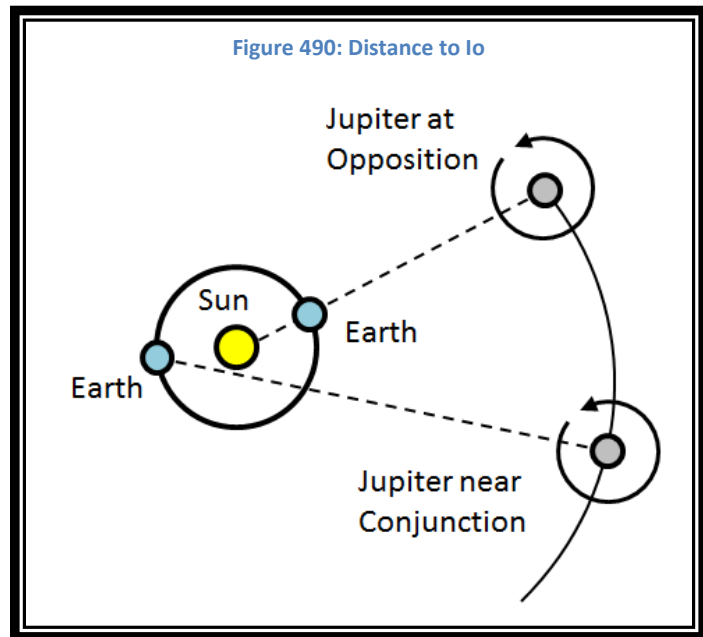
### Old Problems Get New Solutions

Isaac Newton was not the only natural philosopher working on important astronomical problems in the late 17<sup>th</sup> century CE. Giovanni Domenico Cassini (1625-1712), an Italian astronomer and astrologer, was hired by Louis XIV of France in 1669 to establish an observatory

in Paris. As head of the new Paris Observatory, Cassini hired an assistant, Jean Richer, and dispatched him to Cayenne, just off the South American coast near French Guyana. With Richer in Cayenne and Cassini in Paris making simultaneous angular measurements of the position of the planet Mars, Cassini calculated the Earth-Mars distance by parallax, or triangulation. Then using Kepler's Laws, he calculated the distance from the Earth to the Sun, or 1 AU, the Astronomical Unit. Cassini's value of 140,000,000 km (about 87,000,000 miles), turns out to be off by less than 7%. (A modern examination of Cassini's notes, however, has determined that there were many inaccuracies in both astronomers' measurements, but their estimate of the baseline distance between Cayenne and Paris was also well off the mark. The errors mostly canceled out, luckily giving a reasonably good final value. Such was the reputation of Cassini throughout Europe that later attempts to determine the Astronomical Unit were always referred back to his 1672 measurement, and those who came up with a significantly different number tended to withhold their own.)

Another of the assistants at the Paris Observatory was a Dane, Ole Roemer (1644-1710). Roemer was measuring the periods of the orbits of the moons of Jupiter, but over several years kept

getting values that differed significantly. Jupiter's moon Io has a period of about 42 hours on average, as determined by the moment Io disappears (is occulted) by Jupiter's disk. But instead of variations of perhaps a few seconds, he was getting variations of several minutes. In 1676 he figured it out: as the Earth in its orbit got closer to Jupiter (at opposition), Io's period got shorter than the average by 11 minutes; and when the Earth got farther away at conjunction), Io's period got longer than the average by 11 minutes. The conclusion: the light from Io had farther to travel at conjunction than at opposition, which affected the timing of the eclipses measured by Roemer back on Earth. With values for Cassini's Astronomical Unit, Roemer concluded that it took light 22 minutes to cross the Earth's orbit. This resulted in a calculated speed of light of just over 200,000 km/sec, or about 70% of the current value. This was the first reasonably accurate determination of the speed of light. More importantly, Roemer showed that the speed of light was finite, not infinite as many previously had thought.





Another problem that still had not been solved was the issue of stellar parallax. By the early 18<sup>th</sup> Century CE most natural philosophers had accepted that Kepler's system was correct, but there were still significant holdouts supporting Tycho's geo-heliocentrism who believed that since stellar parallax still had not been observed, heliocentrism was not fact, just a theory.

An English theologian and amateur astronomer named James Bradley (1693-1762), decided to take up the challenge of observing stellar parallax. His method was drawn from a suggestion first made by Galileo, and first attempted by English natural philosopher, Robert Hooke, in 1674. In the diagram, a telescope is mounted vertically, and secured so that it cannot move, stability being the chief advantage of this setup. This limits the observer to stars that can be seen at the zenith, but any reasonably bright star would serve. The idea was to make very accurate measurements of a selected star, and, over time, it was hoped that slight differences in position would be found as the Earth moved in its orbit. Unfortunately for Hooke, his attempt was made in a rented London apartment (note the hole he cut in one of the floors so he could observe from the floor below, and the hole in the roof), and the landlord took a very dim view of Hooke's alterations. The attempt was abandoned, mainly because the building shook any time horse-drawn wagons went past his "observatory."

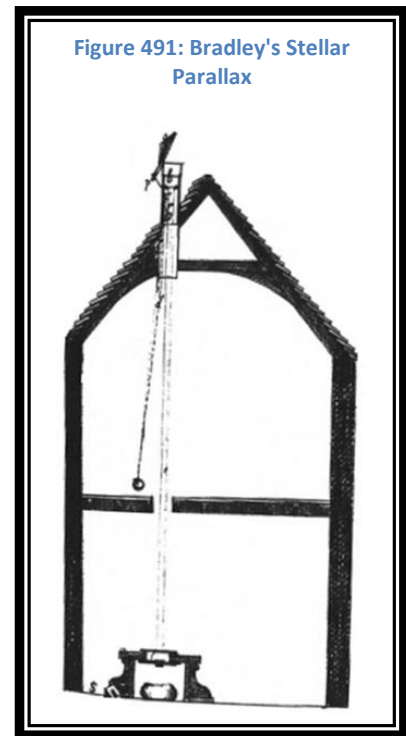


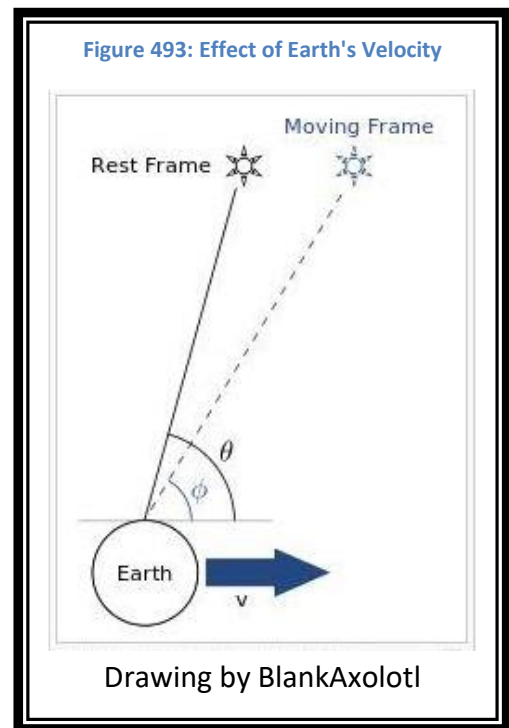
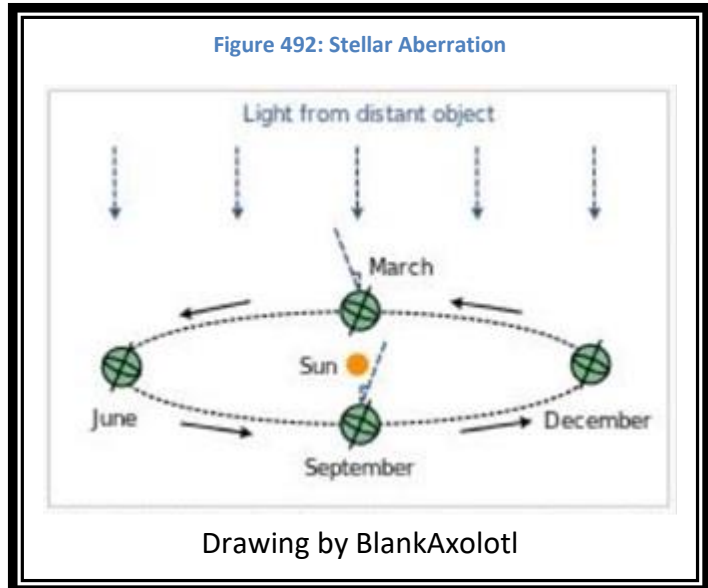
Figure 491: Bradley's Stellar Parallax

James Bradley adopted a similar set-up in 1725. With Samuel Molyneux, a wealthy amateur who purchased a purpose-built telescope and contributed his mansion in Kew Green, outside London, Bradley established his version of a zenith observatory. At the latitude of London, the star Gamma Draconis passes directly overhead, and Bradley chose it as the target for stellar parallax. After working through various problems with mounting the scope (he strapped it to a chimney), keeping it vertical (using a plumb bob), and other issues, Bradley was able to get precision measurements good to 1 arc-second. He calculated that if stellar parallax was detectable with his setup, it would reach its extremes in December and June, and appear as a slight annual "wobble" in the position of Gamma Draconis. After the unexpected death of Molyneux, Bradley continued observations with a second purpose-built telescope mounted in a cottage owned by his aunt.

Observations that Molyneux and Bradley made were added to by Bradley alone well into 1728. He detected a wobble, but it was much too large and occurred at the wrong time, maximizing in March and September instead of what he had predicted. In the diagram you can see that in March and September the incident rays from a star swing through the largest angle for an observer on Earth's northern latitudes. It wasn't until late in 1728 the Bradley understood what was happening.

The effect discovered and explained by James Bradley is called stellar aberration. An analogy helps to visualize it: suppose you are walking in the rain with an umbrella, where the rain is falling straight down; but in order to protect your legs from getting soaked, you have to tilt the umbrella forward a bit to intercept the raindrops in flight. This is true no matter what direction you walk; you always tilt the umbrella in the direction of your motion. Stellar aberration works the same way, where starlight stands for the rain, the moving Earth stands for the walker, and a zenith telescope stands for the umbrella. Bradley realized from Ole Roemer that the speed of light is finite, and therefore takes a finite time from the moment light enters the telescope until it is observed at the eyepiece. Bradley was actually measuring the angle the telescope had to be tilted to intercept the falling starlight, which would only be necessary if the Earth was moving. Stellar aberration was thus observable proof that the Earth does move in an orbit around the Sun.

In ensuing years Bradley would find another subtle wobble, called nutation. The Earth is a sphere, but not a perfect one. During its formation from molten rock, the spinning Earth became somewhat thicker at the equator, and slightly flattened at the poles (the Earth is now described as an oblate spheroid). The Moon's gravity tugs a bit more strongly on the thickened

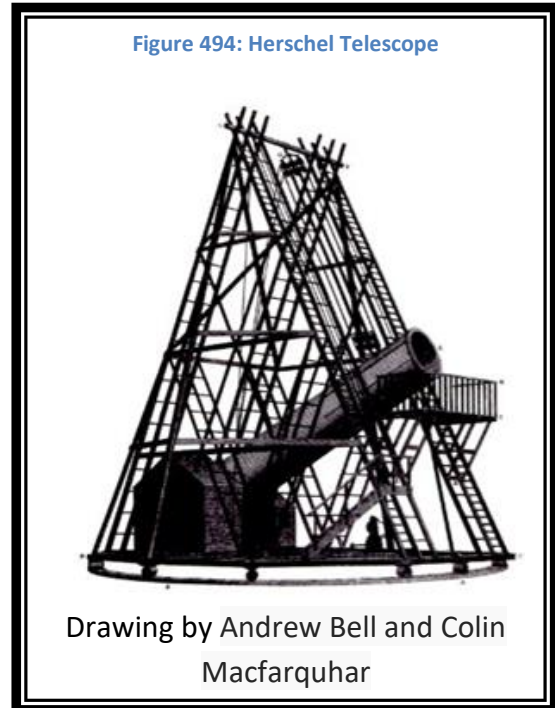


equator than on other parts of the globe, and that added force causes a slight wobble in the Earth's axis. For those astronomers seeking finally to observe stellar parallax, Bradley's discoveries of aberration and nutation were added to precession and atmospheric distortions, making the job even trickier than before. Stellar parallax would have to be teased out of a series of wobbles – a wobble within a wobble. For Bradley, though, these discoveries elevated him to the highest ranks of European astronomers, where he was named England's Astronomer Royal after the death of Edmond Halley in 1742.

### **William Herschel (1738-1822)**

Born Friedrich Wilhelm Herschel in Hanover, Germany, Herschel anglicized his name shortly after his arrival in Bath, England, in 1757. He was employed as a musician and conductor, but early on became obsessed with astronomy and building telescopes. Initially he built refractor telescopes, but was disappointed with problems endemic to all refractors of that era, chromatic aberration and the very long telescope tubes used to minimize its effects. So he switched to building reflector telescopes.

Like Isaac Newton, Herschel made the objective mirrors of his telescopes out of metal. Soon after bringing his sister, Caroline, from Hanover to be his assistant, in 1772, he produced a 5" mirror made of an amalgam of copper, tin, and antimony (called speculum). So pleased was he with this first attempt, he began a building craze that filled every room of their cottage with mirror blanks, grinding and shaping tools, and all the other materials and apparatus needed for telescope construction. Between 1773 and 1795, Herschel built and polished 430 telescope mirrors, ranging in size from the 5" model he started with, up to two mirrors each weighing one ton and with diameters of four feet. A telescope with a 4-foot mirror required a tube 40 feet long, and also required several people to operate (note the circular track, the pulleys, the movable observing platform just under the nose of the telescope). He also found it difficult to keep them polished, and the heavy mirrors tended to deform under their own weight. He much preferred a telescope he made that had a 19" mirror and a 20-foot tube. He spent hundreds of nights systematically "sweeping" the sky, calling out his observations for Caroline to record.



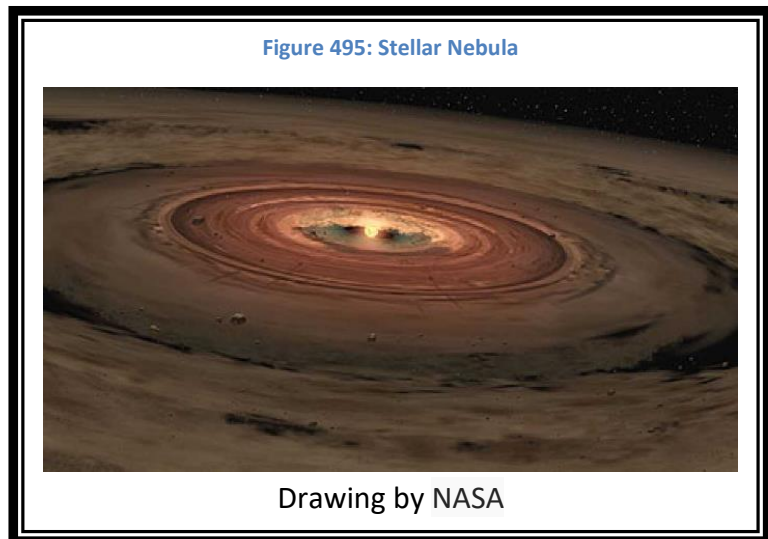
On the evening of March 13, 1781, Herschel recorded what he at first thought was a comet. But over the next few weeks he determined that the object did not move like a comet, finally concluding that the new object must be a new planet. He had discovered Uranus. He became instantly famous, receiving numerous awards and recognition from professional astronomers all over Europe. He went on to discover two moons of Uranus (Oberon and Titania), as well as two moons of Saturn (Mimas and Enceledus). While working on methods for observing sunspots, he found that using a red filter produced a lot of heat; this suggested that something interesting was happening at the red end of the solar spectrum: infrared light, which raised the temperature of a thermometer placed just beyond the red end of the visible spectrum. He was the first to measure the axial tilt of Mars, and the first to conclude that the solar system itself is moving through space.

William Herschel's legacy is a rich one. He initiated what later historians have called "aperture fever," where sheer size of telescope objectives became a goal in itself. He issued three catalogs of stars and other objects, which were supplemented by observations made by Caroline and, later, his son John. When these were supplemented some years later by John Dreyer in 1888, it was called the New General Catalog of 7840 deep sky objects. The NGC numbering system is still in use today.

## **Laplace and the Nebular**

### **Hypothesis**

The late 18<sup>th</sup> – early 19<sup>th</sup> centuries witnessed more than just new telescopes and new observations. Astronomical theory also evolved after Newton's theory of gravity. Questions arose as to the origins of the solar system and how it developed. One line of speculation that had implications for current theories of solar system evolution was the nebular hypothesis.



The nebular hypothesis was first suggested by scientist/theologian Emanuel Swedenborg in 1734, and expanded by philosopher Immanuel Kant in 1755. But it took on its most detailed and plausible form in the work of Pierre-Simon Laplace. This version of the theory survived well into the 19<sup>th</sup> century.

Laplace (1749-1827) was sent by his father to the University of Caen in Normandy, France, to study theology. But early on he discovered a great talent for mathematics, so he abandoned Normandy for Paris. Recognized by such pillars of French science as Joseph-Louis Lagrange and Jean le Rond d'Alembert, they found Laplace stable employment as a teacher. His main fields of mathematics were in probability and statistics, and later he considered problems in astronomy related to the long-term stability of the solar system. It was out of this later work that he produced the nebular hypothesis.

Beginning with a large cloud of incandescent gas, a rotating disk of material formed as the cloud cooled and condensed. As this process continued, the speed of rotation increased, causing successive rings of material to be cast off. From these rings, planets condensed one-by-one to form the solar system as we know it today. A general outline of this process was published in 1796 in his Exposition du Système du Monde, (*Exposition of the System of the World*), and a full, mathematically reasoned version later appeared in his Mécanique Céleste (*Celestial Mechanics*, vol. 1 and 2, 1799, with a total of 5 volumes through 1825).

The physics of this model was later criticized by the great 19<sup>th</sup> century physicist James Clerk Maxwell, who demonstrated that Laplace's theory must be rejected because it fails to conserve angular momentum. But portions of the nebular hypothesis were revived in the 20<sup>th</sup> century, including the Sun "condensing" out of a gaseous nebula, and the formation of protoplanetary disks.

### **Finally, Stellar Parallax**

The story of how stellar parallax was successfully observed for the first time is the story of two men. One, the telescope builder, was Joseph von Fraunhofer; the other, the astronomer, was Friedrich Bessel. By the 1820's, several astronomers across Europe had taken up this challenge, using differing strategies, equipment and techniques. So there was a bit of a competition going on, though a friendly one. But it was Bessel who was the eventual winner when he became the first to publish his results in 1838.

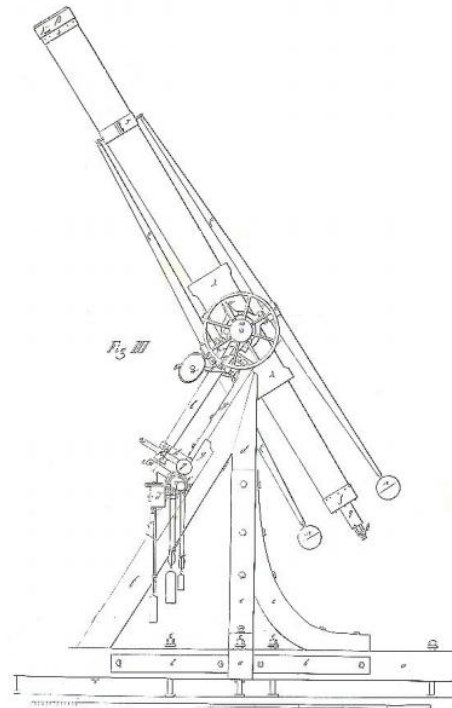
Joseph von Fraunhofer (1787-1826) was born in Bavaria and was orphaned at age 11. He became apprenticed to a glassmaker, whose shop was so ramshackle that it collapsed, trapping the 14-year-old Joseph in the rubble. By chance, the Prince-Elector of Bavaria, Maximilian Joseph, was passing nearby and organized his rescue. So taken by this apparent miracle, the prince began to take an interest in the boy and arranged to give him books and to require of Joseph's employer time off each day so that he could study. The investment quickly proved fruitful as Fraunhofer began to improve many of the processes of glassmaking. By 1809 he became part of the firm's management, and later its director.

Beginning with improvements in the design of the furnaces, Fraunhofer developed methods for precisely measuring and controlling temperatures. He experimented with formulas for casting new types of glass and developed new methods of testing them. In particular for astronomy, Fraunhofer invented new machines for grinding and polishing lenses that were far in advance of the state of the art. Along the way, he produced a special telescope for viewing light from his furnaces through a prism, which he also used on light from the Sun: this was the invention of the spectroscope (he catalogued 574 absorption lines in the solar spectrum, and the brightest of these are still called the Fraunhofer lines).

Word gradually spread of the remarkable results he was getting, and astronomers were insistent that he build telescopes for them. When he finally decided to do so, he also made innovations in mounting and controlling telescopes. This figure shows the design for the Dorpat refractor, built for astronomer Wilhelm Struve, and completed in 1824. The 9.5" objective lens was not only the largest, clearest, most flawless of any lens ever produced up to that time; Fraunhofer had corrected it for chromatic aberration (the tendency of a lens to focus light of different colors at different focal points, making for a very annoying rainbow effect). This was the first precision achromatic telescope.

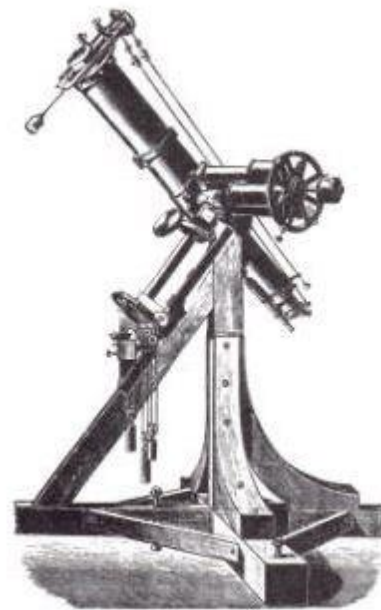
The mounting was also innovative. One axis is oriented to the celestial pole, making it possible to track stellar movements by simple rotation around that axis. Note the weight-driven mechanism for that turning, which was designed to match the rate at which celestial objects appear to move

Figure 496: Dorpat Refractor



Public Domain

Figure 497: Königsberg Heliometer



Public Domain

across the sky. This was the invention of the so-called “German equatorial” mount, Bavaria then being a part of greater Germany.

Unfortunately, Fraunhofer would only live long enough to complete one more telescope, the Königsberg heliometer that Friedrich Bessel used. Here you can see how the mounting is the same as for the Dorpat refractor. The difference is that the telescope’s objective lens is really two lenses mounted side by side. Fraunhofer crafted a 6” achromatic lens, then, using a diamond, cut the lens in half. So Bessel actually had two telescopes. The advantages of this design were two-fold: atmospheric disturbances that plague all telescopes would be exactly the same in each telescope, which would now be easy to deal with; the second was that measurements of star positions would be more accurate, as the operator positioned the two images to overlap. Using a micrometer indicator, the amount of the lens movement could be determined very precisely. So even though the 6” objective was much smaller than the 9.5” objective of the Dorpat refractor that Struve was using, the Königsberg refractor was significantly more precise.

Joseph Fraunhofer lived long enough to see that the Königsberg refractor was completed to his specifications, but died in 1826 before Bessel received it. He had established a new standard for precision astronomy both in conception and in fabrication.

### **Friedrich Bessel (1784-1846)**

Friedrich Bessel was the son of a low-level government functionary, so at age 15 he dropped out of school and migrated to the bustling port city of Bremen where he signed on as an apprentice for an import-export firm. His days were spent writing and copying business correspondence, but at night he studied finance and overseas trade. He hoped one day to involve himself in international trade and traveling the world.

Bessel discovered that he loved the precision of numbers, and by age 20 he had become a rising star in his firm’s accounting office by self-study and talent. In preparation for his planned travels, he began the study of navigation, and soon mastered the use of sextants, chronometers, charts, and tables. This is where he got bitten by the astronomy bug. He quickly mastered Newton’s Principia and the works of Edmond Halley, after which he decided to calculate more precisely the orbit of Halley’s Comet. Wishing to check his work, he contacted Bremen’s leading astronomer, Wilhelm Olbers. Olbers was quite impressed with the young man, and consulted with his good friend, Carl Friedrich Gauss, the pre-eminent mathematician of the early 19<sup>th</sup> century. They decided to help Bessel get a job in astronomy.

Thus it was that Bessel gave up his dreams of an exciting life as a world traveler and settled in Lilienthal, a small, bucolic village where he served as an assistant to its resident astronomer.

Using a reflector set up much the same as Herschel's, Bessel learned at first hand the frustrations of trying to carry out observations that involved a team of assistants to move the telescope and try to get it pointing at his target star. (One wonders if he was tempted in those years to go back to Bremen where he was offered a salary seven times the amount he was making in Lilienthal.) But his commitment was total, and for five years he persevered, corresponding with astronomers all over Europe and mastering the arts of astronomical observation.

Like astronomers everywhere, Bessel dreamed of better equipment. He envisioned himself making significant upgrades to the star atlases of his day, a task that most astronomers found tediously boring; but, as a numbers guy, this appealed to him. Astrometry – the precision measurement and mapping of star positions – was Bessel's calling. In November, 1809, his dreams came true: out of the blue he received a letter from none other than Friedrich Wilhelm III, King of Prussia, who offered him a position as director for a new observatory to be constructed at the University of Königsberg, in Prussia. It seems that all that correspondence had taken root, and Alexander von Humboldt, advisor to the king, had recommended Bessel for the job.

Bessel arrived in Königsberg in the spring of 1810, but Napoleon was on the march in those years, so it wasn't until 1813 that the observatory was completed. He used that time to begin a mathematical analysis of James Bradley's observations of 3000 stars, published in 1755. Factors that he included were the effects of the atmosphere, peculiarities of Bradley's instruments, and even peculiarities of Bradley's own observational habits (for example, he determined that observations of one of Bradley's assistants was systematically off by one second, which Bessel added back into each of that assistant's observations). This project took Bessel seven years to complete, but by the end he had revolutionized the procedures for "reducing" the raw observational data. A new standard was being established where no inaccuracies would be tolerated, and where every observatory would have to search for its own idiosyncratic sources of error.

In 1820, Bessel received a Fraunhofer-influenced precision transit circle, which he used during the next decade to measure the positions of 32,000 stars, which established him as the premier observer in Europe. It was at that point that Bessel decided to take up the challenge of stellar parallax. He didn't do this lightly, because he was all too aware of the many well-publicized failures of the past. As a numbers guy and an acknowledged leader in precision astrometry, he knew his reputation was on the line. Even after receiving the Fraunhofer heliometer, Bessel used it for five years before beginning the attempt, time he spent analyzing every source of error he could find and obsessively tweaking his instruments and his methods.



His first step was to choose a target star. He settled on 61 Cygni. An Italian astronomer, Giuseppe Piazzi, a Theatine monk in Palermo, Sicily, was respected for his discovery of the first asteroid, Ceres. In the northern constellation of Cygnus, the Swan, was a small, undistinguished star that had one distinguishable feature: a large proper motion that Piazzi had measured to be 5.2 arc-seconds per century when compared to nearby stars. Bessel concluded that 61 Cygni, “Piazzi’s Flying Star,” was moving so fast because it must be relatively close to the Sun. And the closer the star, the easier it should be to measure its parallax.

As it turned out, the Königsberg heliometer resolved 61 Cygni into a double star, so Bessel had two stars to measure and check against each other. Beginning in August, 1837, Bessel was spurred on by word that Wilhelm Struve, using the Dorpat refractor, was attempting to measure the parallax of the star Vega, the brightest star in the constellation of Lyra, the Lyre. The race was on, and Bessel knew he was behind because he needed a full year of observations to be certain of his results.

In December, 1838, Bessel was confident enough to publish his results. The parallax was quite small: 0.318 arc-seconds. This made it possible to determine its distance: 660,000 AU, which meant that the actual velocity of 61 Cygni relative to the Earth was 170,000 miles per hour, truly a “flying star.” To check his work, Bessel completely disassembled his telescope and re-assembled it, searching for any source of error. He then repeated his observations of 61 Cygni, measuring the parallax this time as 0.348 arc-seconds, a difference of about 10% from the original (the modern value is 0.287 arc-seconds).

Bessel was offered the directorship at the prestigious Berlin Observatory, but he turned it down to stay in Königsberg. But his fame as an astronomer allowed him finally to travel the world, receiving honors wherever he went.

### **The Discovery of Neptune**

Johann Gottfried Galle (1812-1910) was designated by King Friedrich Wilhelm IV to be the successor to Bessel at the Königsberg Observatory in 1847. The year before, on September 23, 1846, Galle discovered the planet Neptune.

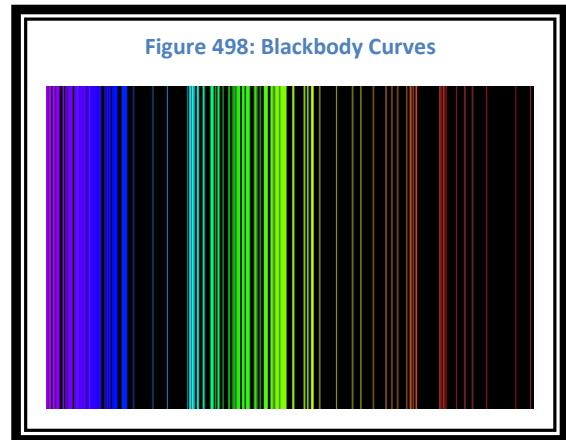
Galle was the son of a tar oven operator who believed in the power of education to raise his son’s prospects. He sent Johann to the Friedrich Wilhelms University in Berlin in 1830, where, after graduation, he briefly taught mathematics and physics before becoming an assistant to Johan Franz Encke at the Berlin Observatory in 1835. The Berlin 22.5cm refractor had been begun by Fraunhofer, and after his death was completed to his specifications by his assistants, so it was a premier instrument.

While working as an assistant, Galle completed his Ph.D. dissertation in 1845, analyzing observations Ole Roemer had made in 1706. He sent copies of his work to astronomers across Europe for comment and criticism, which was standard practice; and one of the recipients was Urbain LeVerrier, a French mathematician at the Paris Observatory, where Roemer once worked. LeVerrier did not reply until September, 1846, but his letter did not mention Roemer.

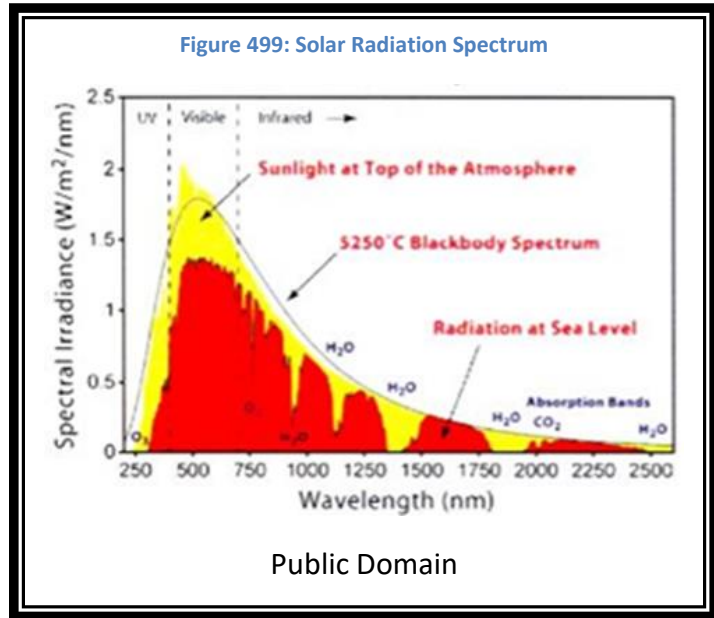
Urbain LeVerrier (1811-1877) studied at the École Polytechnique, one of France's top universities, and in the 1830's he worked briefly with the chemist, Joseph Louis Gay-Lussac. When LeVerrier got bitten by the astronomy bug it was celestial mechanics that attracted him. His earliest work was on the stability of the solar system, a very complex problem involving the gravitational forces of all of the planets acting on each other all of the time. By late 1845, LeVerrier began to find that observations of the planet Uranus could not be accounted for by the influences of the known planets. He concluded that Uranus was being "perturbed" by an unknown eighth planet beyond the orbit of Uranus. In August, 1846, he finally had a mathematical prediction for the position of the new planet. The Paris Observatory did not have adequate telescopes, he felt, so he wondered if someone at the Berlin Observatory would help him out. That's when he remembered that dissertation about Roemer sent to him by Galle.

On September 18, 1846, LeVerrier posted a letter to Galle with its predicted position. Galle received it on the 23<sup>rd</sup>, and immediately requested permission for telescope time for the same night from Encke. Encke was skeptical, but finally relented. Galle and one assistant found the new planet less than 1° from its predicted position. This was a major confirmation of the power of celestial mechanics and Newton's law of gravitation.

But the discovery of the new planet was not without controversy. An Englishman, John Couch Adams (1819-1892; his middle name was pronounced "cooch" by his native Cornish relatives), also claimed discovery of the new planet, also by analyzing perturbations in the orbit of Uranus. Adams was the son of a poor tenant farmer who got bitten by the astronomy bug as a youngster. At age 16 he observed the return of Halley's Comet, and resolved to calculate its orbit. His mother received a timely inheritance that allowed Adams to attend Cambridge University as a sizar, just like his hero Isaac Newton. When he graduated in 1843 he was at the top of his class.



According to Adams, he had worked out a position for the new planet by the middle of 1845. But a series of miscommunications and missed appointments with the Astronomer Royal, George Biddell Airy, delayed an actual search. But by the summer of 1846, Airy had heard about LeVerrier's efforts and was struck by similarities he found in Adams' work. Desiring that England obtain the glory of discovery, Airy induced James Challis at the Cambridge University Observatory to begin an immediate



search. After Galle's announcement it was later determined that Challis had actually observed the new planet on August 8<sup>th</sup> and August 12<sup>th</sup>, but didn't realize it because he had out-of-date star charts.

Adams always accorded the right of discovery to LeVerrier and Galle, and apparently held no ill will toward Challis or Airy. He would go on to do important work on the subtleties of the Moon's orbit. As for Galle, he turned down the appointment at Königsberg due to academic politics; he later became director of the observatory at Breslau. And LeVerrier continued his work on celestial mechanics; in 1859 he discovered an anomaly in the orbit of Mercury that could not be accounted for by using Newtonian mechanics. This anomaly would go unexplained until 1915, when it was successfully explained by Albert Einstein.

### **Astronomical Spectroscopy: A Powerful New Tool**

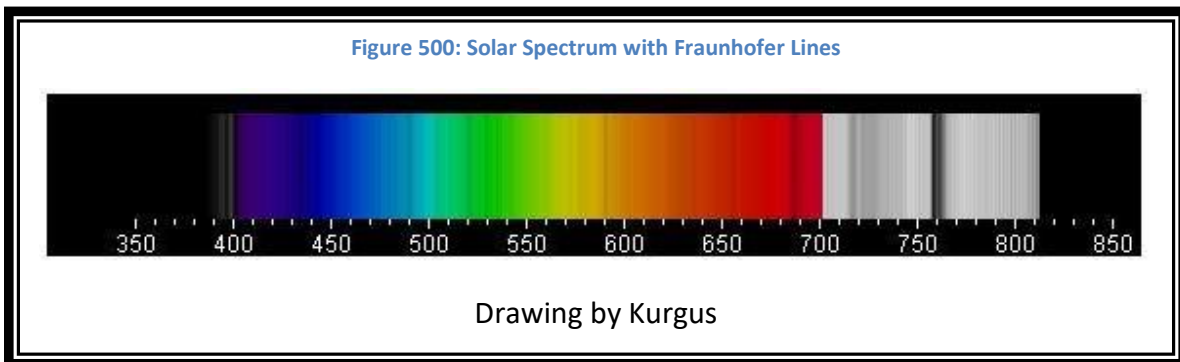
Gustav Robert Kirchhoff (1828-1887) was born in Königsberg, the son of a lawyer, who sent him to the University there. Kirchhoff was not an astronomer, but his radiation laws would revolutionize the ability of astronomers to analyze the light they captured in telescopes. With his colleague, chemist Robert Bunsen at the University of Heidelberg, Germany, they established the theory of Black Body Radiation in 1860. Kirchhoff analyzed a hypothetical object that would be a perfect radiator and absorber of heat, which he called a Black Body. This led him to the radiation law:  $\lambda_{\text{max}} = 2,897,820 / ^\circ\text{K}$ , where  $\lambda_{\text{max}}$  is measured in nm ( $10^{-9}$  meter).

When plotted as shown in the diagram, the temperature of a heated object could be determined from the peak intensity of its blackbody curve. This led them to three radiation laws associated with the spectra of heated materials:

## Astronomy for Mere Mortals – An Introductory Astronomy Text

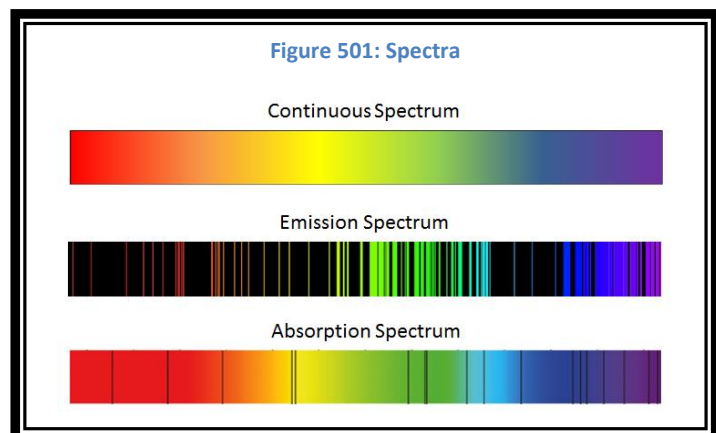
1. An incandescent solid or a gas under pressure will produce a continuous spectrum
2. An incandescent gas under low pressure will produce an emission-line spectrum.
3. A continuous spectrum viewed through a low-density gas at low temperature will produce an absorption-line spectrum.

From the spectra obtained for various substances, Kirchhoff and Bunsen were able to identify different chemical elements, a powerful analytical tool for chemists, but also for astronomers. One of the first applications for this new tool was an analysis of the Sun's spectrum. Due to various effects arising from sunlight having to penetrate the layers of the Earth's atmosphere, the solar spectrum is somewhat different from a perfect blackbody. This diagram shows the results of modern measurements that take place at different levels of the atmosphere in order to show how the Sun conforms to the typical blackbody curve. Since the Sun's outer layers are a gas at low pressure, dark absorption lines are recorded by a spectroscope. So now it was possible to determine the chemical composition of the Sun and other objects, as well as their temperatures.



Among a rapidly growing number of spectroscopists was Anders Jonas Ångström (1814-1874), a graduate of Uppsala University and later keeper of the Uppsala University Observatory in Uppsala, Sweden. He was the first to use an etched glass grating rather than a prism to obtain spectra. This new technique allowed him to measure over 1000 absorption lines in the Sun's spectrum, which he published in 1868. His measurements all used units of  $10^{-10}\text{m}$ , which are now known as Ångström Units (Å), still widely used today.

Through spectroscopy, American astronomers finally stepped on to the world stage. Henry Draper (1837-1882) used yet another new technology –



photography – to record the spectrum of the star Vega at Harvard University. His successor, Edward Pickering (1846-1919), built a team at Harvard that used advances in photographic methods combined with newer, more precise diffraction gratings to complete the Henry Draper Catalogue of over 230,000 stellar spectra which quickly became an international standard (the HD Catalogue).

Pickering's team was unusual for its day, in that he employed women ("Pickering's harem" as they were dismissively referred to by his colleagues). At the height of the Draper project, 80 women worked as "computers," that is, they were responsible for the long, tedious, and boring computations that were thought to be too much drudgery for their male counterparts, and they were paid the grand sum of \$0.25 per hour. But out of all that repetition came an intimate knowledge of subtle variations and consistencies in the data, which bore unexpected fruit later on.

One of those women was Annie Jump Cannon (1863-1941), the daughter of a Delaware state senator and shipbuilder. Under the encouragement of her mother, Cannon attended Wellesley College to study astronomy, receiving a degree in physics in 1884. Over the next decade she traveled widely and developed skill in the new art of photography. She joined Pickering's team in 1896.



Cannon early on in the project negotiated a compromise among various team members on how to classify the stars they were cataloguing. Under her direction, stars would be divided into spectral classes designated as O, B, A, F, G, K, M. Her scheme was based on the strength of the absorption lines in the visible spectrum of each star. It was Cannon herself who came up with the mnemonic "Oh Be A Fine Girl, Kiss Me" as a way to remember the order of the spectral classes. During her lifetime, Annie Jump Cannon manually classified 350,000 stars, more than anyone else in history.

One of Cannon's colleagues was Henrietta Swan Leavitt (1868-1921), who was the daughter of a Congregational minister in Lancaster, Massachusetts. She attended Radcliffe College, graduating in 1892, where she got bit by the astronomy bug. She started work as a computer

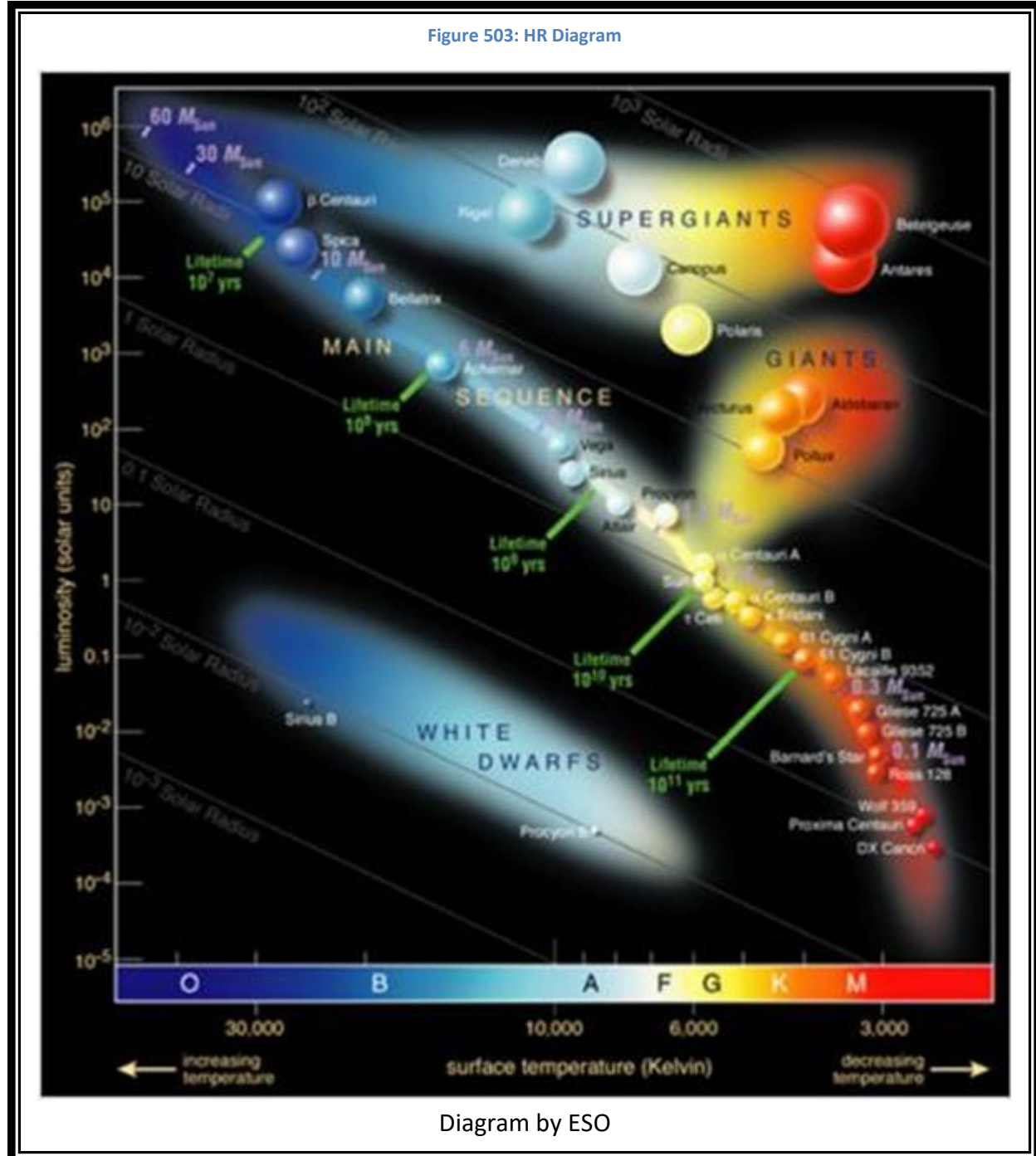
for the Draper project in 1893, and was later assigned by Pickering to focus on variable stars. The work was long and difficult because several photographic plates taken over time were needed just to determine that a star was a variable.

But after 15 years of analysis, in 1908 she concluded that stars in the Magellanic Clouds (minor galaxies visible in the southern hemisphere) contained many variable stars, some of which exhibited interesting regularities. Since these stars were grouped together in the cloud, she assumed as an approximation that they were all equidistant from the Earth, which meant that variations in brightness must be due to the stars themselves and not to differences in their distance from the Earth. For a particular class of variables, called Cepheid Variables (first discovered in 1784 by astronomer John Goodricke for the star Delta Cephei), she found that the intensity of the Cepheid was directly related to the period of its variation: the brighter the Cepheid, the longer it took for it to cycle from maximum to minimum to maximum again.

By 1912 she had additional corroborating data and published her findings. Her discovery, known now as the period-luminosity law, made it possible to determine stellar distances without resorting to stellar parallax. Leavitt's Law was the first "standard candle," meaning that a measure of the period and intensity of any Cepheid anywhere could be compared to a known standard, and distance to that Cepheid could then be determined quickly and easily, a fact that astronomer Edwin Hubble would later use to his distinct advantage.

Another result of the Draper project was the classification system developed by Henry Norris Russell (1877-1957), and Danish astronomer Ejnar Hertzsprung (1873-1967). During the years 1911-1913, Russell and Hertzsprung collaborated to produce the Hertzsprung-Russell diagram.

Figure 503: HR Diagram



Here you can see a graph of luminosity versus surface temperature (and spectral class). What they discovered was the first hint of the story of the birth and death of stars, in other words, stellar evolution. In just a few decades, spectroscopy had completely transformed astronomy.

### **The Universe Expands**

Physics in the decade 1895-1905 underwent a period of transition so abrupt and transformative that it has sometimes been called the Second Scientific Revolution. X-rays were discovered in 1895, radioactivity in 1896, the electron in 1897, the early quantum theory was proposed in 1900, and the special theory of relativity appeared in 1905. No such revolution occurred, however, where the age and large-scale structure of the universe was concerned. Cosmology had changed little since Newton's day.

The age of the universe was an unsolved problem. By the end of the 19<sup>th</sup> century, estimates for the age of the Earth varied widely. Geologist Charles Lyell and biologist Charles Darwin favored estimates in the hundreds of millions of years. But the physicist William Thomson, Lord Kelvin, using thermodynamics for the time a molten Earth would have taken to cool to its current state, estimated that the Earth was only 20 million years old.

As for the size of the universe, astronomers still believed that the Milky Way galaxy was the only such structure in existence. The billions of objects that we know today as other galaxies were thought to be curious "spiral nebulae" in our own galaxy. Some astronomers had suspicions that they might be extra-galactic, but there was no observable proof to think differently.



It is only in retrospect, of course, that we can see this state of affairs as decidedly provincial. What were needed were larger telescopes with greater light-gathering power. The last half of the 19<sup>th</sup> century had witnessed the fabrication of ever-larger refractor telescopes. The firm of Alvan Clark & Sons in Cambridgeport, Massachusetts, were masters of the art of lens-grinding, producing objective lenses for Lowell Observatory (24-inch), the United States Naval Observatory (26-inch), Lick Observatory (36-inch), and Yerkes Observatory (40-inch) in 1897. But the Yerkes Observatory lens was so massive it would deform under its own weight. It had to be periodically rotated to ensure that it didn't sag too far in any one direction. No larger lens has ever been successfully used for astronomy. So by 1897 the state of the art for refracting telescopes had entered a cul-de-sac; the Yerkes 40-inch is still the world's largest refracting telescope. For astronomers to gain more light-gathering power, therefore, the switch to large reflector telescopes was inevitable.

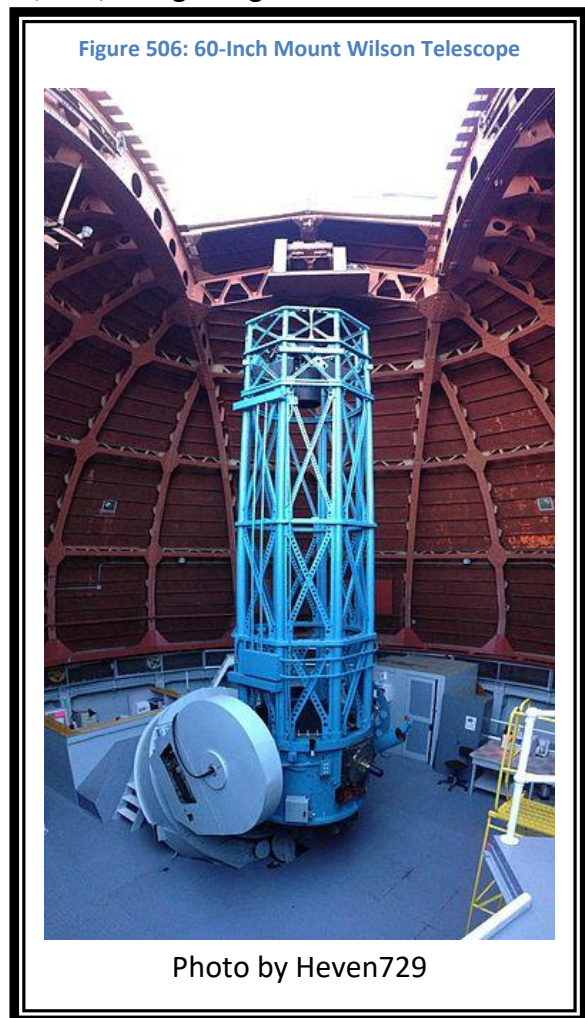
Reflectors had traditionally been fabricated from speculum metal, as we saw with Newton and Herschel. The largest telescope of this type was built in 1845 by the 3<sup>rd</sup> Earl of Rosse, in Parsonstown, Ireland, with a speculum mirror measuring 72 inches in diameter. Though it remained in operation until 1890, its effectiveness was limited by its lack of mobility, the rapidity with which the mirror tarnished and needed repolishing, and the fact that Parsonstown only averaged about 60 nights per year that were good enough for observing. Reflectors had distinct advantages over refractors in that era. Overseeing the transition from lenses to mirrors was George Ellery Hale (1868-1938), son of a wealthy manufacturer in Chicago, Illinois. Hale's early interests in



astronomy were encouraged by his father, who bought him an Alvan Clark refractor that Hale used to learn astrophotography and to begin a life-long study of the Sun. He attended the Massachusetts Institute of Technology, where, as an undergraduate, he invented the spectroheliograph, a telescope designed specifically to photograph the Sun in specific wavelengths of light. He gained further expertise at the Harvard College Observatory under Edward Pickering, and at the Berlin Observatory. Shortly thereafter he joined the faculty at the University of Chicago, where, in 1897 he designed and then managed the 40-inch Yerkes refractor and its associated laboratories. (Figure 571 is from several years later, during a visit by Albert Einstein, fifth from the right.)

But Hale was always thinking about bigger telescopes, and, recognizing that refractors were a dead end in that respect, he began to design large reflecting telescopes. To that end, his father commissioned a 60-inch glass mirror blank as a gift to his son. When Hale received funding for an observatory from the newly established Carnegie Institution in 1904, Hale and his team began grinding the mirror and searching for a suitable site. In December, 1908, the Hale 60-inch telescope on Mt. Wilson, near Los Angeles, saw “first light.” While this instrument was still under construction, Hale began designing an even larger telescope with a 100-inch mirror, financed by a grant from hardware magnate John D. Hooker, and additional funding from Andrew Carnegie personally. The Hooker telescope saw first light in November, 1917. In the 1930’s, Hale went on to design the 200-inch reflector that was eventually installed on Mt. Palomar in late 1948, and which was posthumously named after him. Thus, George Ellery Hale designed what were in his day the four largest telescopes of their type in the world.

As it turned out, the 60-inch reflector on Mt. Wilson was not large enough to change cosmology. But with the 100-inch everything did change. Using Leavitt’s Law for Cepheid variables, Edwin Hubble was finally able to resolve individual Cepheids in the Andromeda Galaxy. The distance worked out to nearly a million



light-years, well beyond the confines of the Milky Way. The universe had just become a lot bigger.

Edwin Hubble (1889-1953), the son of an insurance executive, graduated from the University of Chicago in 1910 and then became a Rhodes Scholar, where he studied law at Oxford University for three years at the request of his father. When his father died in 1913, Hubble decided he didn't want to be a lawyer and began the process of re-tooling as an astronomer. He did his astronomical "apprenticeship" at the Yerkes Observatory studying different kinds of nebulae, where he came to the attention of Hale, who hired him to help staff the new Hooker telescope. The 1923 discovery of extra-galactic Cepheids in Andromeda was followed with measurements of other Cepheids in other nearby galaxies.

Hubble then turned his attention to the question of why almost all galaxies seem to have their spectra shifted to the red end of the scale. Was this due to the Doppler shift, indicating that all those galaxies are receding from us? Building on the pioneering work done at the Lowell Observatory in Flagstaff, Arizona, by Vesto Melvin Slipher, and with spectroscopic data provided by his colleague at Mt. Wilson, Milton Humason, Hubble finally concluded that the observed redshifts were directly proportional to the distances of those galaxies. A doubling of the redshift meant a doubling of the distance. The year was 1929.

### **Einstein and Cosmology**

Albert Einstein (1879-1955), was the son of an electrical engineer and early on showed a talent for mathematics and physics. Though born in Ulm, Germany, Einstein chose to become a Swiss citizen at age 16 to avoid military service (he was a life-long pacifist). He entered the Zurich Polytechnic, graduating in 1902, only to find that none of his professors would recommend him for a job because of Einstein's habit of cutting classes to work independently. Through a friend, he finally got a job at the Swiss patent office in Bern in 1903 as a patent examiner, third class.

Easily able to complete his work quickly, he used his spare time at the patent office to pursue theoretical physics (this picture shows Einstein at his work desk in 1905, his "miracle year").

In 1905, Einstein published three groundbreaking scientific papers:

1) Demonstrating that light must be both emitted and absorbed in discrete “quanta” in order to explain how electrons are displaced from metals when irradiated by ultraviolet light – the so-called “photoelectric effect.”

2) Demonstrating from statistical methods how the random movements of small pollen grains suspended in water must require the existence of molecules – the so-called “Brownian Motion.”

3) Demonstrating from two postulates:

1) the constancy of the speed of light in any inertial reference frame (moving at a constant speed); and

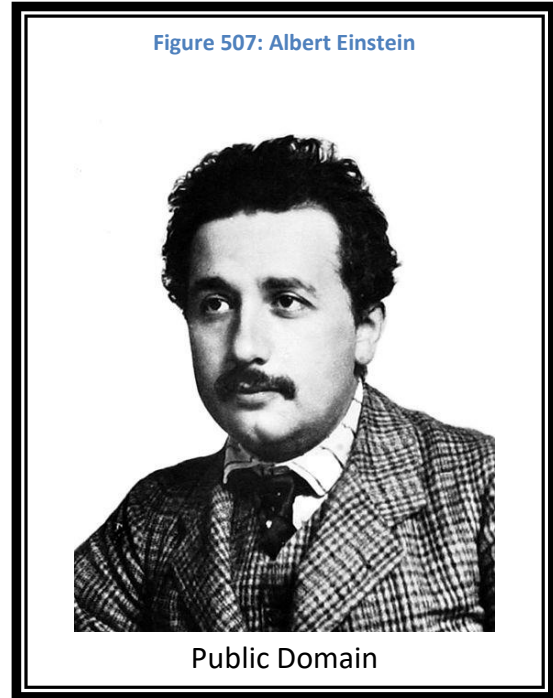
2) treating all inertial reference frames as equivalent; Einstein went on to show that the familiar concepts of space, time, and mass undergo transformations not in accord with Newton’s laws of motion – the so-called “theory of special relativity.”

A fourth paper, a few months later, demonstrated that mass and energy are equivalent, the now famous  $E=mc^2$ . Einstein was 26 years old.

There was no immediate recognition by other physicists of these results, any of which were career-making publications. The only significant change in his status in 1905 was that his provisional status as a patent examiner was changed to permanent. But the special theory of relativity is only valid for systems moving at constant velocity, and Einstein began to wonder if relativity could be expanded to dynamical systems, systems that undergo accelerations.

In 1907 he began to think about gravity. It occurred to him that a person in free-fall does not experience gravity. This is true for any object in free-fall, so all such reference frames are equivalent. Further, a person standing on the earth experiences the force of gravity as 1g, which would be the exact experience a person in empty space in a spaceship propelled at a steady acceleration of 1g would feel. This equivalence is deceptively simple, and from it (and some rather daunting mathematics) would emerge the “general theory of relativity” in 1915.

We need not immerse ourselves in 4-dimensional pseudo-Riemannian geometry and curved space-time to appreciate the results of Einstein’s quest. The path of a light beam will be altered



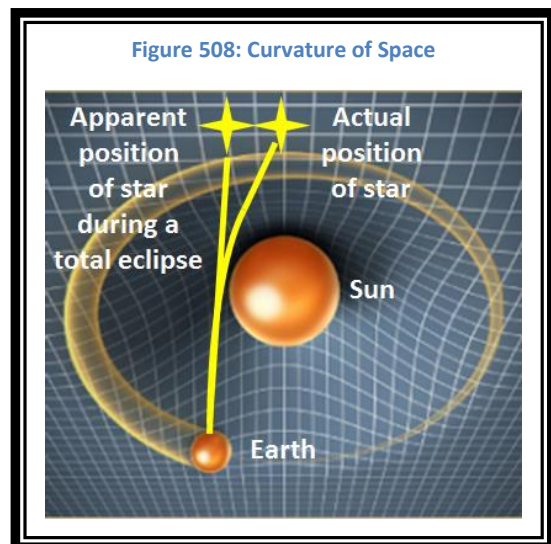
by a gravitational field, as was first measured by English astronomer Arthur Stanley Eddington (1882-1944), in May, 1919. Gravity will cause a Doppler red-shift in objects accelerating or decelerating relative to the Earth. And the precession of Mercury's orbital perihelion that Urbain LeVerrier had discovered but could not explain, was exactly accounted for in the theory by the effects of gravity on space-time. Each of these effects was confirmed by astronomers. Where Einstein's 1905 papers were virtually ignored, general relativity theory made Einstein an international scientific superstar.

The impact on cosmology was gradual but revolutionary. In 1917 Einstein turned his attention to the universe as a whole, beginning the field of relativistic cosmology. In accord with the general views of the day, he assumed that the universe was static, and added a new parameter that did not emerge directly from his field equations, the cosmological constant, to force his equations to produce a static universe. But other mathematicians, notably the Russian, Alexander Friedmann (1888-1925), and the Belgian priest Georges Henri Joseph Édouard Lemaître (1894-1966), pointed out those solutions to the field equations strongly implied that the space-time continuum must be expanding. In 1929, Edwin Hubble's results on galactic red-shifts showed that the most distant galaxies were receding the fastest; therefore, the universe was expanding. A chagrined Einstein exclaimed that his cosmological constant was the biggest blunder of his life. But all the predictions of general relativity theory, including gravitational waves, have been borne out by observation and experiment. Theory and observation are in agreement: we live in an expanding universe.

### **The Solar System Expands, Too**

By the end of the 1920's professional astronomy had become the province of Ph.D.'s, huge telescopes, and precision instrumentation. It is interesting to note, then, that one of the most celebrated discoveries of the 20<sup>th</sup> century was made by a high school graduate with a 13-inch telescope.

Clyde William Tombaugh (1906-1997) was the son of a farmer in Streator, Illinois, who got bitten by the astronomy bug as a boy. His plans to attend college were thwarted, however, when a hail storm destroyed an entire crop, plunging his family into debt. Beginning in 1926 Tombaugh began building a series of telescopes from materials he could scrounge, and he made sketches of his observations of Mars and Jupiter. He sent some of his work to the Lowell Observatory in Flagstaff, Arizona, which was famous for its work on



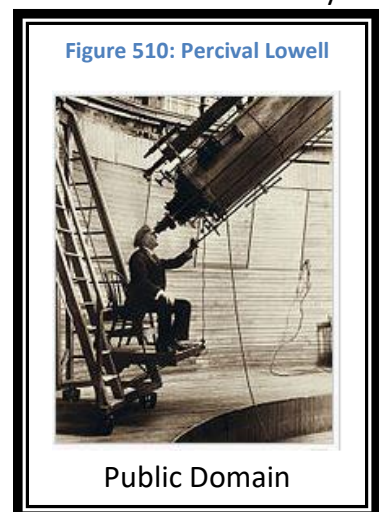
Mars. He was hoping for advice on how to improve his methods. What he got in return was a job offer.

When Tombaugh arrived in Flagstaff in January, 1929, he was taken under the wing of the observatory's director, Vesto Slipher. Tombaugh was an amateur who needed to be trained in every aspect of his assigned duties: there was the use and maintenance of the 13-inch refractor; there was the Zeiss blink comparator; there were the 14" by 17" photographic plates that had to be precisely mounted to the scope and developed with extreme care. All of these tasks would be needed for the project he was assigned: go out and discover a new planet.

The effort to find a planet beyond the orbit of Neptune was begun by the observatory's founder, Percival Lawrence Lowell (1855-1916), a member of the wealthy Lowell family of Boston, Massachusetts. He was sent to Harvard, of course, where he graduated with highest honors in mathematics. Subsequently he worked in the family business, and traveled widely throughout Asia. When he returned he decided to build a private observatory, and chose Flagstaff, in the Arizona Territory, because of its altitude and for the many nights of clear weather.

Inspired by the work of Italian astronomer, Giovanni Schiaparelli, who had mapped "canali" (Italian for "channels") on the surface of Mars, Lowell decided to commit himself to the study of the red planet's "canals," because he believed Mars was inhabited by an advanced race of beings that had desperately constructed canals to funnel water from the Martian polar icecaps to its population centers in ever-widening central deserts. In 1894 he began construction of Lowell Observatory, and in 1896 he received from Alvan Clark & Sons a 24-inch refracting telescope.

Searching for Martians was not Lowell's only interest. Early on he became aware that Neptune alone could not account for all the perturbations in the orbit of Uranus. Between 1896 and his death in 1916, Lowell assembled an experienced staff and a number of additional instruments, including a 42-inch reflector telescope, to begin the search for the new planet. But Lowell's death brought operations nearly to a standstill due to complications with his will. Not until 1926 was the search resumed, at which time the observatory commissioned a 13-inch astrograph, specially designed for wide field



photography, by C. A. R. Lundin, chief optician at Alvan Clark & Sons. They took delivery of the astrograph one month after the arrival of Clyde Tombaugh.

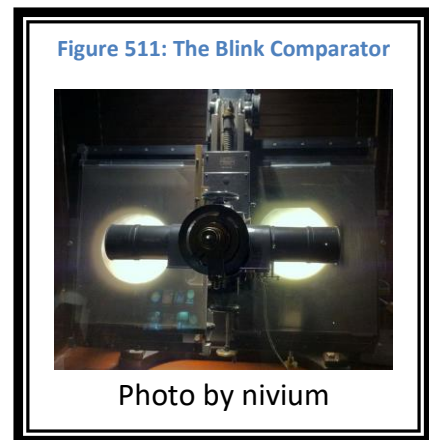
After mastering all the steps in the process of imaging, Tombaugh had to perform the incredibly tedious comparison of the developed plates. Each plate contained images of hundreds of individual stars, each of which would have to be compared with their positions on a second photographic plate taken several days or weeks before. This was done with a blink comparator, a device that projected first one, then the other plate to the viewer, who would blink them back and forth looking for any change in position. Almost always, no change would be observed, and Tombaugh would mark each star as he went. Rarely, there would be a jump from one plate to the other, but this was always due to an asteroid. Most of the asteroids he observed were known, but over the course of about two years he discovered 15 new asteroids.

But things changed on February 18, 1930, when he was comparing plates taken on January 23<sup>rd</sup> and January 29<sup>th</sup>. There was an ordinary-looking star-like object that jumped, but a much smaller distance than was usual for fast-moving asteroids. Subsequent observations confirmed what he had hoped, and an orbit was calculated for the new object. The announcement of the discovery of a new planet, later designated as Pluto, was made on March 13, 1930, Percival Lowell's birthday. Hubble may have increased the size of the universe, but Clyde Tombaugh had increased the size of the solar system.

### **How the Universe Began: Big Bang vs. Steady State**

The astronomical revolution that occurred between 1915 and 1930 left one fundamental question untouched: How did it all begin? This is an age-old question going back to the beginning of history. Many guesses both mythological and scientific have been advanced over the centuries, without resolution. With the new telescopes and advanced theories, was it possible to find an answer that would meet scientific scrutiny?

The results of relativity theory and of Hubble's observations strongly suggested that the universe is currently expanding. So if it is expanding now, in the past it must have been smaller than it is today. If you go back far enough, there must have been a moment of creation from nothing. But some scientists and philosophers rejected this as impossible on grounds that science does not recognize creation *ex nihilo*, that is, for every material effect there must be a material cause. Several decades passed without conclusive evidence one way or another. One critic of the idea of a single moment of creation for the entire universe, astronomer Fred Hoyle



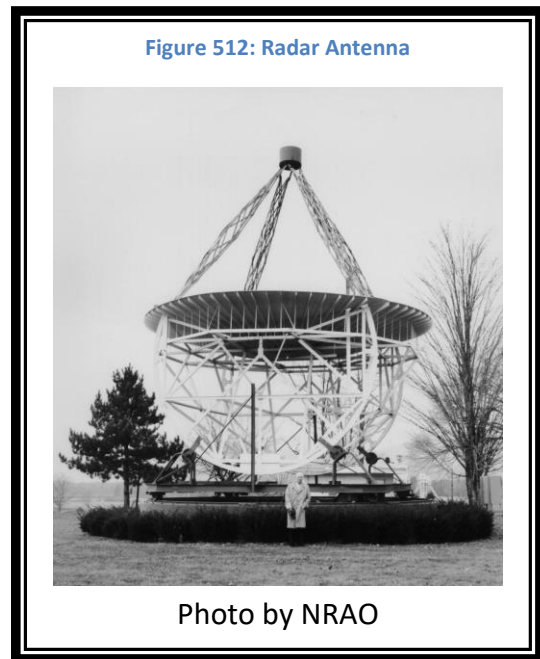
(1915-2001), derisively said during a popular radio broadcast in 1949 that it was as if the universe had been created in a “big bang.” The term stuck.

The Steady State theory was propounded by physicists Herman Bondi (1919-2005), Thomas Gold (1920-2004), and Fred Hoyle (1915-2001) in a series of scientific papers beginning in 1948. At the heart of the theory was what has become known as the Perfect Cosmological Principle, which states that at the largest scales the universe is essentially the same at any time and in any direction (homogeneous and isotropic). The Big Bang theory employs a more restricted principle stating that in the past the universe was fundamentally different than it is now and how it will be in the future. Steady State theory asserts that the universe is essentially always the same: the universe is eternal.

Bondi, Gold, and Hoyle did not dispute Hubble’s findings that the universe is expanding. To maintain homogeneity, therefore, they posited the spontaneous creation of matter between individual galaxies so that the average density of the universe would always remain a constant. They computed that it would only take one new atom per cubic meter per billion years. Critics immediately attacked this idea of spontaneous creation as absurd and unscientific. But they retorted in kind: it was no more absurd or unscientific than having the entire universe suddenly explode into existence out of nothing. What was needed was hard data to resolve the issue.

Beginning in the late 1950’s astronomers began to produce observations from all-sky surveys that seemed to support the Big Bang. The post-World War II era witnessed the advent of radio-astronomy and its expansion into the microwave region of the electromagnetic spectrum, largely due to wartime experience with radar (Bondi, Gold, and Hoyle all worked on radar for Great Britain during the war). By 1963, the 200-inch telescope at Mt. Palomar and other observatories began to detect in visible light what the radio-telescopes were finding, namely “quasi-stellar objects” that were very small for the huge amounts of energy they were radiating.

Observing objects like 3C 48 and 3C 273 in visible light meant that they’re spectra could be imaged, and very large red-shifts were measured. At the same time, these small, star-like objects (hence “quasi-stellar” and later shortened to “quasars”) were emitting the kinds of





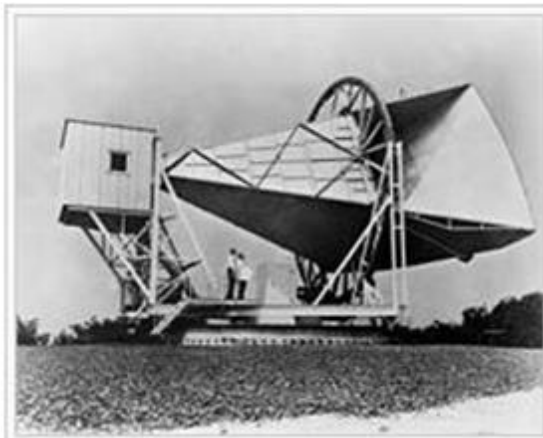
energies reminiscent of entire galaxies. This quandary was exploited by both the proponents of the Big Bang and by the adherents of the Steady State theory, often in quite ingenious ways. But now that the field of radio astronomy had proven its worth, it had another ace up its sleeve that would prove to be decisive. And it came about completely by accident.

In 1964, Arno Penzias (born 1933) and Robert Woodrow Wilson (born 1936) were physicists working for the Bell Telephone Laboratories on a supersensitive microwave receiver intended for satellite communications. Located in rural Holmdel, New Jersey, measuring a modest 15 meters across and shaped like a horn, their antenna nevertheless had state-of-the-art electronics cooled to near absolute zero. Penzias and Wilson had spent a lot of time and effort trying to eliminate all spurious radio sources, including commercial radio and the radio “glow” from New York City. But a nagging persistent hiss kept them from achieving the results they anticipated, so they doggedly tracked down every possible source, including cleaning a layer of pigeon droppings from inside the horn. Still, there was a hiss that seemed to have no identifiable source and was constant night or day.

At nearby Princeton University, astrophysicist Robert H. Dicke (1916-1997) and his team were preparing to build a similar receiver expressly to detect the remnants of the Big Bang “explosion.” Penzias and Wilson got word of this and contacted Dicke to see what they had theorized such a signal should look like. They learned that it should be isotropic and correspond to a temperature of about 5°K, which is almost exactly what they were getting (they got 3°K). They suddenly realized that their annoying hiss was actually the faint echo of the Big Bang.

The discovery of the Cosmic Microwave Background (CMB) convinced the overwhelming majority of astrophysicists that the Big Bang theory had won the debate over the Steady State theory. Over the next few decades additional observations of quasars showed that they were not evenly distributed throughout the cosmos, confirming that the past was fundamentally different from the present. The Perfect Cosmological Principle would have to be abandoned. The universe was not eternal.

Figure 513: The Horn Antenna



## **Epilog**

It has not been the intention or within the purview of this brief history of astronomy to consider every twist and turn of the historical record. Many interesting stories and many key findings have been left out. Interested readers are encouraged to discover for themselves other fascinating episodes and people.

Since World War II, astronomy has experienced a remarkable transformation not limited to radio astronomy. After the launch of Explorer I in early 1958 and the discovery of the Van Allen radiation belts, a continuous stream of ever more sophisticated spacecraft (including flybys, orbiters, and landers) has demonstrated the advantages of doing astronomy beyond the Earth's pesky atmosphere. At the same time, a new era of mega-telescopes much larger than Mt. Palomar's 200-inch Hale reflector have been constructed, employing new detectors and adaptive optics. A whole new zoo of strange and interesting objects has been discovered since the quasars, including pulsars, gamma-ray bursters, and black holes. The nebular hypothesis has been completely re-worked using advances in nuclear physics and computer modeling of accretion disks. Nuclear physics itself has become increasingly dependent on astronomy for its theories involving energies well beyond the capabilities of Earth-borne particle accelerators.

The enterprise of astronomy has itself changed. Cutting edge instruments and observing programs are now rarely the result of individuals like Percival Lowell, or through the contributions of philanthropists like James Lick and Charles T. Yerkes. Such resources now come from scientific foundations, university consortia, national governments, and international organizations. Professional astronomers find themselves spending as much time writing grant proposals and serving as project managers as they do on their scientific work.

At the same time, some of the same advances in computing and imaging have become available to the general public. It is now possible for an astronomical enthusiast with a modest investment of time and money to contribute relevant scientific data, and even search for extra-solar planets.

Suffice it to say that the 21<sup>st</sup> century has many exciting avenues to explore and new mysteries to solve. What is dark matter? Will dark energy be explained with the help of the new gravitational wave detectors? But some of the same questions raised in ancient Babylon and Alexandria are with us today: What is the nature of the Cosmos, and where do humans fit into the grand scheme of things? As can be seen from this short historical sketch, a key tool in the search for answers to such questions has been, and will continue to be, astronomy.

## Index

---

### A

Absolute Brightness · 107, 108, 251  
 Absolute Magnitude · 107, 108, 109, 236, 254, 284, 285, 386  
 Absolute zero · 96  
 absorption lines · 238, 342  
**Absorption Spectrum** · 97, 98  
 accretion disk · 309, 332, 333  
**Active Galactic Nuclei** · 333  
 Active Galaxies · 333, 409, 411  
 Active Galaxy · 333, 395, 409  
 Active Optics · 80, 395  
 adaptive optics · 81  
 Adaptive Optics · 81, 395  
 Alpha Process · 269, 278, 280, 282, 298, 299  
 altitude · 22, 24, 65, 74, 76  
 Altitude · 395, 415  
 ammonia · 122, 141, 192, 202, 203, 209, 210, 292, 293, 366  
 amplitude · 67  
 Amplitude · 395  
 Andromeda Galaxy · 18, 19, 33, 319, 339  
 Angular Momentum · 120, 264  
 annular eclipse · 41  
**Apollo** · 129, 154, 221, 396  
**Apollo Asteroids** · 221  
 Apparent Brightness · 107, 251  
 apparent magnitude · 108, 215, 217, 218, 251, 386  
 Apparent Magnitude · 107, 108, 149, 161, 168, 178, 189, 201, 207, 236, 284, 386, 405, 412, 414  
 Aristotle · 30, 50, 51, 53, 56  
 asteroid · 64, 79  
 Asteroid Belt · 105, 116, 117, 120, 217, 220, 396, 405  
 asteroids · 16, 117, 177, 184, 186, 195, 200, 218, 220, 221, 226, 369, 411  
 Asteroids · 117, 130, 215, 220, 221, 395, 396, 399, 405  
 astrometry · 79  
 astronomical unit · 16, 31  
 atmosphere · 15, 40, 69, 80, 81, 82, 85, 98, 117, 122, 124, 127, 137, 138, 139, 140, 141, 142, 147, 148, 152, 156, 158, 161, 166, 167, 168, 170, 174, 176, 179, 181, 182, 183, 185, 190, 191, 192, 196, 197, 201, 203, 208, 210, 226, 236, 237, 238, 240, 242, 244, 298, 299, 351, 366, 367, 374, 399, 402, 403, 405, 410, 415  
 Atomic Epoch · 360, 396

AU · 16, 105, 106, 118, 119, 130, 156, 161, 168, 178, 189, 201, 207, 215, 217, 218, 230, 257, 264, 324  
 autumnal equinox · 36  
 Axial Tilt · 133, 149, 156, 161, 165, 168, 178, 180, 189, 201, 202, 207, 209, 236  
 azimuth · 22, 24, 65, 76  
 Azimuth · 396

---

### B

Balmer Series · 92, 102, 294, 396, 400  
 Barred-Spiral Galaxies · 313  
 Barringer Meteor Crater · 222  
**Belts** · 147, 181, 396, 414, 415  
 benzene · 293  
 Big Bang · 82, 261, 291, 312, 322, 348, 349, 351, 352, 353, 355, 356, 358, 360, 361, 362, 363, 396, 398, 401, 403, 404, 405, 408, 409, 412  
 Bighorn Medicine Wheel · 46  
 Binoculars · 285, 384  
 black body curve · 95  
 Black Dwarf · 267, 270, 298, 396  
 Black Dwarfs · 261  
 black hole · 290, 332, 333, 402  
 Black Hole · 300, 303, 304, 305, 306, 307, 314, 331, 395, 396, 402, 411  
 black holes · 291, 331, 334, 335, 340, 361  
 Blackbody Curve · 333, 397  
**Blazar** · 336  
 blue-shifted · 103  
**Bow Shock** · 118  
 Brahe · 53, 54  
**Brown Dwarf** · 261, 262, 286, 397  
 brown dwarfs · 253  
 Building Blocks of life · 368

---

### C

Callippus · 50, 51  
 Callisto · 184, 185, 397, 402  
 Caloris Basin · 158, 397  
 Cannon · 58  
 carbon · 137, 139, 141, 166, 176, 234, 247, 269, 270, 278, 298, 299, 311, 365, 397, 410  
 Carbon Detonation Supernova · 311

## Astronomy for Mere Mortals – An Introductory Astronomy Text

cascade · 92  
cassegrain telescope · 75  
**Cassegrain Telescopes** · 75  
Cassini · 196, 198, 397  
Cassini Davison · 198  
Cassiopeia · 53, 390, 391  
CCD · 75, 77, 78, 79, 80, 397  
celestial equator · 63, 76  
**Celestial Equator** · 397  
celestial sphere · 25  
Celsius · 96, 383, 397, 404  
central bulge · 314, 332  
Central Bulge · 314  
**Cepheid Variables** · 107, 108  
**Ceres** · 116, 217, 400  
Chandra X-Ray Telescope · 82, 86, 334  
Chandrasekhar Limit · 311, 397  
Chicxulub Crater · 222  
chromatic aberration · 73  
**Chromatic Aberration** · 397  
Chromosphere · 240, 397, 414  
Clyde Tombaugh · 216  
CNO Cycle · 278, 398  
colors · 70  
Coma · 223, 391, 398, 404  
comet · 64, 79, 130, 223, 224, 225, 398, 406  
**Comet Hale-Bopp** · 225  
**Comet Shoemaker-Levy 9** · 225  
comets · 16, 117, 130, 224, 225, 226, 230, 411  
Comets · 117, 130, 223, 224, 225, 398  
Compton Gamma Ray Observatory · 82, 87, 303  
**Condensation** · 121, 264, 398  
constellation · 25, 28, 29, 111, 294, 317, 389  
Contact Binary Stars · 309  
**Continuous Spectrum** · 97, 398  
coordinate system · 22, 62, 63, 64  
Copernicus · 53, 154  
**Core** · 135, 136, 151, 157, 162, 169, 180, 191, 239, 280, 281, 299, 300, 311, 398, 408, 409, 410, 411, 412  
Corona · 163, 240, 241, 389, 391, 398, 414  
Coronal Mass Ejections · 244, 398  
Cosmic Microwave Background Radiation · 312, 349, 351, 352, 353, 360, 374, 398  
Cosmological Principle · 344, 347, 399  
Coude telescope · 74  
Crab Nebula · 300  
craters · 152, 153, 154, 158, 163, 212, 371, 406  
crescent · 38, 164  
crest · 67  
Crest · 399

**Critical Density** · 345, 346, 360, 399  
**Critical Universe** · 346  
Crust · 135, 143, 144, 145, 146, 151, 157, 162, 169, 396, 398, 399, 408

---

### D

Danjon Scale · 40  
Dark Matter · 324, 337, 338, 356, 363, 399  
Dark Nebula · 293, 294  
decay · 247, 278, 283, 356, 412  
declination · 22, 29, 63, 64, 76  
Declination · 50, 399  
Deimos · 168, 177, 399  
**density waves** · 327  
Detached Binary Stars · 309  
**Differential Rotation** · 182, 415  
differentiated · 120, 151, 157, 185, 239, 398  
Differentiation · 120, 122, 134, 399  
diffraction · 66  
**Diffraction** · 399  
Direct Imaging · 112  
Disk · 117, 230, 304, 310, 314, 315, 401, 409, 412  
Distance Modulus · 107, 108  
Distance Tools · 104  
Dobsonian telescope · 77  
Doppler Effect · 101, 102, 109, 383, 400  
Doppler Shift · 101, 103, 110, 111, 250, 387  
Drake Equation · 372, 400  
dust cloud · 98, 103, 263, 264, 265, 290, 291, 293, 294, 295, 297, 299, 398  
Dust Tail · 223  
dwarf planets · 117, 215, 404, 411  
Dwarf Planets · 116, 218  
dwarf stars · 260, 271, 273, 290

---

### E

Earth · 3, 15, 16, 22, 25, 31, 32, 33, 34, 35, 36, 37, 38, 39, 40, 41, 42, 50, 53, 56, 62, 63, 69, 76, 80, 82, 85, 89, 98, 104, 105, 106, 110, 111, 116, 117, 119, 122, 123, 124, 125, 127, 128, 129, 130, 133, 134, 135, 137, 138, 139, 140, 141, 142, 143, 144, 145, 146, 147, 149, 150, 151, 152, 153, 155, 156, 157, 160, 161, 162, 163, 164, 165, 166, 167, 168, 169, 172, 178, 180, 181, 183, 185, 188, 189, 192, 195, 198, 200, 201, 203, 205, 206, 207, 209, 212, 213, 214, 215, 220, 221, 222, 224, 225, 226, 234, 236, 241, 243, 244, 247, 250, 251, 292, 293, 294, 295,

# Astronomy for Mere Mortals – An Introductory Astronomy Text

296, 298, 299, 301, 302, 303, 306, 307, 308, 322, 346,  
351, 363, 365, 366, 367, 368, 369, 370, 371, 372, 373,  
374, 395, 396, 397, 398, 400, 401, 402, 404, 405, 406,  
407, 408, 409, 410, 411, 413, 414, 415

eclipse · 27, 39, 40, 41, 42, 43

Eclipse · 41, 398

eclipses · 39, 40

Eclipses · 39, 184

ecliptic · 42

Ecliptic · 120, 400

Einstein · 27, 32, 57, 59, 68, 159, 250, 305, 306, 307, 308,  
312, 346, 348, 402, 408, 412

Einstein's Theory of General Relativity · 27

Einstein's Theory of Special Relativity · 32

El Caracol · 47

electromagnetic force · 91, 245, 312

electromagnetic spectrum · 70, 71

Electromagnetic Spectrum · 415

electron · 91, 93, 94, 99, 246, 270, 296, 384, 395, 396, 397,  
401, 403, 405, 408

**Electron Degeneracy** · 261, 269, 301, 400

elliptical galaxies · 318, 340

Elliptical Galaxies · 313, 316, 337, 400

emission nebulae · 327, 400

Emission Nebulae · 294, 295, 298, 326, 400

**Emission Spectrum** · 97, 98

Encke Gap · 198

energy · 70, 91

Energy · 91, 93, 99, 139, 306, 354, 355, 362, 366, 383, 386,  
399, 412

equator · 30, 34, 62, 139, 166, 182, 188, 204, 211, 242,  
243, 346, 397, 399

equatorial bulge · 182

equatorial mount · 76

**Eris** · 116, 119, 217, 230, 400

escape velocity · 141, 152, 158, 304, 306

Eudoxus of Cnidus · 50

Europa · 184, 185, 212, 401, 402

**Event Horizon** · 304, 307, 411

excited state · 91, 92

**Excited State** · 93, 94, 401

Exoplanets · 111, 401

Extrasolar · 111, 401

extraterrestrial · 374

eyes · 21, 71, 72, 78, 107, 154

---

## F

Fahrenheit · 96, 383, 401

filaments · 341, 344, 364

film · 78, 79

**Flat Universe** · 346

Flatness Problem · 350, 353, 401

Focal Points · 75

Forbidden Lines · 296

formaldehyde · 293

**Frank Drake** · 372, 373

frequency · 68, 70

**Frequency** · 103, 374, 382, 383, 401

full moon · 34, 38, 40

Fusion · 245, 247, 253, 278, 280, 281, 282, 283, 359, 397,  
400, 401, 403, 404, 407, 409, 411, 412, 413

---

## G

Galactic Epoch · 361, 401

galactic rotation · 33

Galactic Rotation · 337

galaxies · 18, 20, 103, 108, 292, 293, 297, 303, 307, 311,  
313, 314, 316, 317, 318, 319, 322, 328, 331, 332, 333,  
334, 335, 336, 337, 339, 340, 341, 344, 346, 347, 348,  
349, 350, 361, 362, 363, 364, 401, 413

galaxy · 18, 19, 20, 25, 82, 108, 109, 290, 292, 293, 299,  
300, 302, 303, 307, 313, 315, 317, 322, 323, 324, 325,  
326, 327, 328, 329, 330, 332, 333, 335, 336, 337, 339,  
340, 344, 361, 363, 369, 372, 400, 402, 412, 414

Galaxy Evolution Explorer · 86

**Galaxy Rotation Curve** · 324

galaxy supercluster · 19, 20

Galilean Moons · 184, 185, 186, 397, 402, 404, 414

Galileo · 30, 56, 72, 73, 184

**Gamma Ray Burst** · 303, 342

Gamma Ray Bursts · 303, 342, 402

gamma rays · 71, 87, 246, 352, 402

**Gamma Rays** · 336, 402

Ganymede · 184, 185, 214, 371, 402

Giant Planet Migration · 122

Giant Stars · 260, 261

gibbous · 38

Globular Cluster · 329, 405

Globular Clusters · 315, 329, 402, 412

**Globular Star Cluster** · 329

Globular Star Clusters · 326, 329, 330

Gravitational Instability · 121

Gravitational Lensing · 338, 403

**Gravitational Redshift** · 307, 402

gravitational waves · 349

gravitons · 312

gravity · 16, 30, 37, 57, 116, 121, 127, 131, 141, 152, 155,  
158, 159, 182, 187, 199, 215, 220, 226, 239, 247, 261,  
263, 270, 271, 276, 300, 301, 304, 306, 312, 337, 345,  
367, 399, 401, 402, 404, 405, 411, 414  
Gravity Waves · 312, 349  
Great Space Observatories · 82, 86, 87  
Greatest Elongation · 160, 165  
Greenhouse · 139, 166, 402, 403, 410  
ground state · 91, 92  
**Ground State** · 93, 403  
GUT Epoch · 353, 356, 357, 403

---

## H

Habitable Zone · 234, 235  
Halley's Comet · 225  
Halo · 188, 314, 315, 326, 330, 399, 401  
Harvard University's Computers · 58  
**Haumea** · 116, 218, 230, 400  
**Hawking** · 369  
heavy bombardment · 153  
**Heliopause** · 118, 119  
Helioseismology · 241  
**Heliosheath** · 118  
Heliosphere · 118  
helium · 121, 137, 141, 180, 181, 191, 202, 203, 209, 210,  
239, 245, 247, 253, 261, 265, 267, 269, 270, 271, 278,  
280, 291, 292, 298, 299, 360, 403  
Helium · 133, 149, 156, 161, 179, 190, 192, 201, 208, 236,  
237, 261, 269, 270, 273, 299, 349, 359, 360, 398, 399,  
400, 403, 407, 408  
**Helium Flash** · 269, 273, 400, 403  
Hellas Basin · 173, 403  
Homogenous · 344, 399, 403, 407  
Horizon Problem · 351, 352, 353, 403  
Horsehead Nebula · 294  
**HR Diagram** · 107, 254, 257, 260, 261, 265, 403, 405, 412  
Hubble Space Telescope · 82, 363  
Hubble Ultra Deep Field · 82, 361  
Hubble Ultra Deep Field image · 82, 361  
**Hubble's Law** · 103, 107, 109, 322, 349, 387, 403  
hydrogen · 91, 92, 93, 94, 99, 121, 137, 141, 167, 180, 181,  
191, 202, 209, 223, 239, 242, 244, 245, 247, 253, 261,  
265, 267, 270, 271, 276, 278, 286, 291, 292, 294, 298,  
310, 311, 334, 360, 366, 374, 400, 404  
Hydrogen · 96, 102, 141, 156, 179, 180, 190, 191, 201, 208,  
236, 237, 261, 294, 359, 360, 384, 396, 397, 403, 404,  
407  
Hydrogen Envelope · 223, 404

---

## I

**inflation** · 353  
infrared · 68, 71, 81, 82, 84, 85, 89, 92, 99, 103, 139, 166,  
252, 264, 335, 360, 404, 406, 413  
**Infrared** · 100, 334, 402, 404  
Instability Strip · 257  
interferometry · 89  
Interferometry · 404  
Intermediate Mass Black Holes · 332  
International Astronomical Union · 29, 215, 217  
Interstellar Dust · 292, 404  
Io · 184, 185, 402  
Ion Tail · 223  
iron · 135, 151, 157, 169, 183, 185, 280, 290, 292, 413  
Irregular Galaxies · 313, 317, 404  
Isotropic · 344, 399, 404, 407

---

## J

Jovian · 116, 125, 126, 399, 404, 410, 415  
Jupiter · 27, 50, 56, 116, 117, 119, 122, 123, 124, 125, 130,  
178, 179, 180, 181, 182, 183, 184, 185, 186, 188, 191,  
192, 193, 194, 195, 196, 200, 203, 210, 220, 221, 225,  
231, 257, 261, 371, 396, 397, 401, 402, 403, 404, 405,  
413, 414, 415

---

## K

Kelvin · 96, 383, 386, 404  
Kepler · 54, 55, 57, 73, 111, 187, 324, 382  
Kirchoff · 97  
Kirchoff's Laws · 97  
Kuiper Belt · 116, 117, 119, 120, 195, 215, 217, 218, 223,  
224, 230, 231, 405, 407, 411

---

## L

Lagrangian Point · 197  
landers · 127, 162, 173, 175, 370  
Large Magellanic Cloud · 317  
latitude · 62, 63, 64, 76  
Leavitt · 58  
lens · 66, 72, 73, 75  
Lepton Epoch · 358, 405  
life · 15, 82, 120, 124, 128, 139, 140, 141, 234, 247, 257,  
261, 263, 264, 265, 267, 271, 273, 278, 280, 282, 283,

## Astronomy for Mere Mortals – An Introductory Astronomy Text

299, 309, 328, 349, 354, 365, 366, 367, 368, 369, 370,  
371, 372, 373, 385, 396, 401, 403, 405, 407, 409  
light-year · 31  
Lippershey · 56  
Local Galaxy Group · 19  
local group · 317, 318  
Local Group · 319  
Local Group of Galaxies · 319  
local neighborhood · 17, 288  
**Long Gamma Ray Bursts** · 303  
Long Period Comets · 224  
longitude · 62, 63, 64  
Lowell Observatory · 216  
Luminosity · 108, 251, 254, 260, 285, 386, 403, 405  
lunar · 39  
lunar eclipse · 43  
lunar eclipses · 39  
Lyman Series · 92, 405

---

### M

magnetic field · 124, 147, 151, 157, 162, 169, 180, 183,  
185, 191, 194, 204, 211, 242, 244, 292, 301, 302, 408,  
413  
magnetosphere · 182, 183, 194, 244  
Magnetosphere · 133, 147, 156, 179, 183, 189, 194, 201,  
204, 207, 211, 405, 414  
magnitude · 90, 109, 251, 284, 285, 311, 414  
Magnitude Scale · 284  
Main Belt Asteroids · 220  
Main Sequence · 257, 260, 261, 265, 267, 271, 273, 276,  
299, 329, 405  
Main Sequence Turn-Off · 329  
**Makemake** · 116, 217, 218, 230, 400  
Mantle · 135, 143, 151, 157, 162, 169, 406  
mare · 152, 153  
maria · 152, 153, 154, 158  
Mars · 27, 50, 51, 85, 105, 116, 117, 124, 125, 129, 150,  
157, 168, 169, 170, 171, 172, 173, 175, 176, 177, 200,  
220, 221, 370, 371, 395, 396, 399, 403, 404, 407, 408,  
413, 414  
mass · 57, 108, 121, 127, 150, 158, 215, 239, 245, 257, 261,  
263, 267, 269, 271, 273, 276, 277, 278, 282, 283, 286,  
290, 297, 299, 300, 301, 304, 306, 311, 316, 324, 327,  
328, 332, 337, 346, 382, 385, 386, 402, 403, 414  
Matter Dominated Era · 362  
**Maunder Minimum** · 243

Mercury · 50, 51, 59, 105, 116, 122, 123, 124, 125, 156,  
157, 158, 159, 160, 163, 196, 214, 269, 308, 397, 404,  
410, 413  
metallic hydrogen · 180, 183, 191  
meteor · 64  
**Meteor Showers** · 227, 228  
**Meteor Storms** · 228  
meteorites · 226, 229, 370  
Meteoroid · 226, 406  
meteoroids · 16, 117, 396  
Meteors · 226, 227, 228, 399  
methane · 141, 196, 197, 202, 203, 209, 210, 292, 293,  
366, 371  
Microlensing · 112  
Milky Way Galaxy · 18, 19, 20, 33, 118, 293, 298, 301, 302,  
303, 317, 319, 323, 324, 325, 328, 329, 337, 339, 344,  
351, 406  
Mimas · 197  
Molecular Clouds · 293, 406  
molecular hydrogen · 180, 191, 192, 203, 210  
molecules · 69, 97, 99, 103, 138, 152, 166, 226, 253, 292,  
293, 365, 366, 367, 368, 370, 371, 374, 404, 406  
moon · 30, 33, 34, 37, 38, 39, 40, 41, 42, 45, 51, 53, 56, 64,  
72, 82, 117, 128, 129, 131, 139, 149, 150, 151, 152,  
153, 154, 155, 157, 158, 160, 163, 177, 185, 186, 187,  
188, 195, 196, 197, 200, 212, 214, 217, 226, 228, 334,  
371, 403, 406, 410, 414  
moons · 16, 50, 117, 120, 122, 124, 125, 127, 150, 155,  
171, 177, 184, 185, 186, 187, 188, 194, 195, 196, 197,  
199, 200, 205, 206, 212, 214, 216, 217, 218, 221, 371,  
399, 402, 404, 408, 411  
mount · 76  
**Mount** · 145, 172  
Murray · 58

---

### N

NASA · 2, 41, 133, 149, 156, 161, 168, 175, 179, 190, 201,  
208, 236, 264, 265, 342, 368, 370  
**Neptune** · 116, 117, 120, 125, 130, 200, 207, 208, 209,  
210, 211, 212, 213, 215, 221, 230, 231, 270, 398, 404,  
405, 413  
Neutrinos · 246  
**Neutron Degeneracy** · 304, 396, 407  
**Neutron Degeneracy Pressure** · 304, 396, 407  
neutron star · 301  
Neutron Star · 300, 301, 302, 303, 304, 406, 407, 415  
Neutron Stars · 301, 302, 303, 304, 402  
new moon · 37, 38

## Astronomy for Mere Mortals – An Introductory Astronomy Text

Newgrange · 48  
Newton · 27, 57, 59, 74, 159, 324, 346, 382, 407  
Newton's Laws of Gravity · 27  
**Newtonian** · 407  
Newtonian telescope · 74, 75  
Nickel · 280  
**Nitrogen** · 133, 168, 212, 236, 407  
**North America Nebula** · 294  
north celestial pole · 29, 63  
Nova · 310, 407  
Novae · 310  
Nuclear Epoch · 359, 407  
Nucleus · 223, 333, 398, 407  
nutation · 33

---

### O

observation · 27  
**Observation** · 411  
Occam's Razor · 26  
**Occultations** · 184  
**Olbers' Paradox** · 347  
Oort Cloud · 117, 119, 120, 218, 223, 224, 230, 231, 407, 412  
**Open Cluster** · 295, 297, 407  
Open Clusters · 297, 412  
Open Star Clusters · 297, 315, 326, 329  
Open Universe · 346  
orbit · 30  
Orbit · 133, 149, 155, 156, 159, 161, 165, 168, 178, 183, 189, 201, 207, 324, 330, 413, 414  
orbital inclination · 215, 217, 218  
orbital oscillations · 33  
orbital period · 55, 155, 165, 177, 224, 225, 324, 382, 413, 414  
orbits · 30  
**Orbits** · 120, 224  
**Orion Nebula** · 294, 296  
Oxygen · 133, 156, 168, 236, 237, 299

---

### P

Panspermia · 369  
parsec · 31  
partial eclipse · 39, 41  
penumbra · 39  
Penumbra · 242, 408  
penumbral eclipse · 39

period · 68  
Period · 133, 156, 160, 161, 163, 165, 168, 178, 189, 201, 207, 224, 382, 383  
phases · 34, 37, 38, 56, 160, 163, 164, 339  
Phases · 37, 160, 226  
**Phobos** · 168, 177, 408  
Photodisintegration · 280, 300  
photoelectric effect · 68  
Photoelectric Effect · 408  
photometry · 79  
**Photometry** · 408  
photon · 91, 92, 94, 99, 100, 241, 401  
photons · 59, 68, 70, 78, 86, 87, 88, 91, 99, 103, 226, 241, 245, 246, 269, 280, 296, 300, 307, 312, 349, 351, 352, 357, 358, 360, 396, 400, 405, 407, 409, 410, 415  
Photosphere · 240, 242, 397, 408  
Pioneer 10 · 130, 183  
Pioneer Spacecraft · 373  
Planck Epoch · 355, 356  
planet · 30, 45, 50, 51, 53, 54, 55, 64  
planetary nebula · 277  
Planetary Nebula · 270, 298, 299, 408  
Planetary Nebulae · 298, 299  
planetesimals · 231  
**Planetesimals** · 121, 408  
planets · 16, 25, 51, 111, 112, 113, 116, 117, 118, 120, 121, 122, 123, 124, 125, 127, 129, 130, 131, 155, 159, 165, 166, 169, 171, 182, 183, 184, 185, 187, 200, 202, 212, 214, 215, 217, 230, 231, 234, 253, 261, 298, 308, 327, 328, 368, 372, 398, 400, 403, 404, 406, 408, 409, 410, 411, 413  
Planets · 30, 111, 116, 120, 125, 215, 218, 219, 261, 385, 400, 401, 403, 404, 408, 410, 413  
**Pluto** · 116, 130, 214, 215, 216, 217, 230, 400  
Population I Stars · 291  
Population II Stars · 291  
Population III Stars · 291  
precession · 32, 34, 159  
Precession · 159  
prediction · 27  
**Prediction** · 411  
Primordial Elements · 349  
**Proton-Proton-Chain** · 245  
protostar · 120, 264, 273, 409  
Protostar · 264, 265, 271, 273, 395, 409  
pulsars · 113, 302  
Pyramids · 48



---

**Q**

Quark Epoch · 357, 358, 409  
 quarter · 38  
 Quasars · 333, 334, 335, 340, 342, 409

---

**R**

radar · 102, 105, 162  
**Radar** · 104, 105  
 Radial Motion · 101, 250  
 Radiant · 227, 406, 409  
 Radiation Dominated Era · 360  
 Radiation Zone · 240, 241  
 Radio Galaxies · 333, 336, 340  
 radio telescope · 84, 89  
 radio telescopes · 324, 331, 334, 411  
 radio waves · 70, 82, 84  
**Radio Waves** · 409  
**Rapid Process of Neutron Capture** · 283  
 Rayleigh Scattering · 138, 295, 409, 410  
 Recessional Velocity · 110  
 red dwarf · 16, 271, 273  
 Red Dwarfs · 260, 286, 290, 299, 397  
 red-shifted · 103, 307  
 reflecting telescope · 74, 397, 399, 407, 408  
 reflection · 67  
 Reflection · 295, 410  
 Reflection Nebulae · 295, 410  
 refracting telescope · 72  
 refracting telescopes · 72  
 refraction · 66  
 Regolith · 152, 410  
 retrograde rotation · 165  
 revolution · 32, 427, 431, 439, 443, 445, 447, 464  
 right ascension · 22, 29, 63, 64, 76  
 Right Ascension · 410  
 Roche Limit · 187, 199, 310, 385, 410  
 Roche Lobes · 309, 398, 399, 410  
 rotation · 30, 32, 37, 74, 76, 100, 103, 108, 120, 151, 157, 162, 165, 182, 183, 194, 202, 204, 211, 236, 242, 264, 265, 301, 302, 324, 328, 337, 397, 399, 406, 409, 410, 414, 415  
**Rotational Flattening** · 182, 410  
 rotational period · 37, 155, 302  
 rovers · 173, 175, 370  
 R-Process · 283, 410  
**Run-off channels** · 175  
**Rydberg Formula** · 93, 99, 384

---

**S**

Saturn · 50, 116, 122, 124, 125, 130, 183, 189, 190, 191, 192, 193, 194, 195, 196, 197, 198, 199, 200, 213, 221, 231, 371, 403, 404, 410, 413, 414  
 Scattered Disk · 116, 117, 119, 217, 230  
 scientific method · 27  
 Scientific Method · 26, 411  
 scientific theory · 26, 27  
 Scientific Theory · 26, 411  
 Search for ExtraTerrestrial Intelligence · 373  
 SETI · 373, 411  
**Seyfert Galaxies** · 333, 335, 340, 411  
**Shadow Transits** · 184  
 Shepherd Moons · 187, 188, 411  
**Short Gamma Ray Bursts** · 303  
 Short Period Comets · 224  
 sidereal · 165  
 sidereal day · 35  
**Sidereal Day** · 133, 156, 161, 168, 178, 189, 201, 207  
 sidereal month · 34  
**Sidereal Month** · 149  
 sidereal year · 34  
**Singularity** · 304, 411  
**Slow Neutron Capture Process** · 282  
 Small Magellanic Cloud · 317  
 solar day · 35  
**Solar Day** · 133, 156, 161, 168, 178, 189, 201, 207  
 solar eclipse · 27, 41, 42, 306, 308  
 solar eclipses · 39  
 Solar flares · 244  
 solar nebula · 120, 121, 122, 150  
 Solar Neutrino Problem · 246, 411  
 Solar Prominences · 244  
 solar system · 4, 15, 16, 21, 53, 55, 57, 64, 72, 107, 110, 116, 117, 119, 120, 121, 122, 123, 124, 125, 127, 128, 129, 130, 131, 150, 153, 155, 165, 172, 198, 200, 202, 212, 214, 215, 218, 220, 224, 225, 226, 230, 231, 241, 244, 264, 298, 327, 369, 371, 373, 403, 404  
 Solar System · 104, 107, 116, 117, 118, 119, 120, 122, 123, 127, 129, 130, 172, 219, 226, 235, 371, 397, 401, 406, 407, 408, 411  
 solar wind · 118, 122, 130, 147, 183, 241, 244, 412  
 south celestial pole · 63  
 spacecraft · 70, 72, 102, 127, 128, 129, 130, 131, 162, 173, 183, 188, 198, 200, 216, 401, 411  
 Spectra · 97, 296, 382  
 Spectral Classes · 253, 254  
 Spectral Types · 254, 286  
 spectroscope · 79

**Spectroscope** · 412  
**Spectroscopic Parallax** · 107, 412  
 Spectroscopy · 294, 342  
 spectrum · 70, 79, 82, 86, 95, 97, 98, 99, 100, 101, 102, 103, 238, 250, 252, 294, 333, 334, 335, 336, 342, 360, 374, 402, 404, 405, 409, 410, 414, 415  
 speed of light · 31, 68, 105, 246, 304, 305, 306, 307, 352, 376, 383, 386  
 Spiral arms · 315  
 Spiral Galaxies · 313, 314, 327, 337, 396, 402, 411, 412  
 Spitzer Space Telescope · 85, 264  
 spokes · 46, 199  
 sporadic meteors · 226  
 S-Process · 282, 283, 412  
 standard candles · 109, 311  
 star · 16, 28, 29, 30, 34, 35, 64, 79, 81, 98, 101, 102, 107, 111, 112, 116, 118, 120, 234, 239, 245, 250, 251, 252, 253, 254, 257, 260, 261, 262, 263, 264, 265, 267, 269, 270, 271, 276, 277, 278, 279, 280, 281, 282, 284, 290, 291, 295, 297, 298, 299, 300, 301, 302, 303, 307, 309, 310, 315, 316, 317, 326, 327, 328, 329, 330, 334, 337, 338, 347, 386, 389, 395, 396, 398, 399, 400, 403, 405, 407, 408, 409, 410, 411, 412, 413, 415  
 Stellar Black Holes · 331  
 Stellar Epoch · 362, 412  
**Stellar Parallax** · 104, 105, 106, 107, 413  
 stellar remnant · 277, 301, 304  
 stellar winds · 265, 269, 301  
**Stone Circles** · 46  
 Stonehenge · 47  
 stratosphere · 203  
 Strong Force · 283, 355, 413  
 summer solstice · 36, 424  
**Sun** · 16, 30, 33, 34, 116, 138, 139, 165, 200, 215, 235, 236, 237, 238, 239, 240, 242, 245, 247, 254, 263, 264, 265, 267, 273, 278, 288, 324, 326, 367, 386, 395, 397, 398, 399, 400, 401, 403, 404, 405, 407, 408, 409, 411, 413, 414, 415  
 Sunspot Cycles · 242  
 sunspots · 56  
 Sunspots · 56, 236, 242, 413  
 supernova · 53, 277, 279, 283, 290, 291, 301  
 Supernova · 109, 263, 300, 301, 310, 311, 397, 402, 413  
**Supernova Remnant** · 300  
**Supernovae** · 107, 109, 300, 303, 311, 412  
 surveys · 88, 341, 344  
 synchronous orbit · 155  
 synchronous orbits · 155, 405  
 synodic month · 34, 37  
**Synodic Month** · 149

---

**T**

**tear-drop islands** · 175  
 telescope · 23, 30, 53, 56, 64, 66, 72, 73, 74, 75, 76, 77, 80, 81, 84, 85, 89, 90, 177, 242, 244, 251, 285, 295, 298, 384, 385, 395, 402, 404, 405, 407, 408, 409, 410, 411, 414, 415  
 temperature · 80, 95, 96, 98, 103, 122, 137, 139, 141, 142, 162, 166, 167, 180, 191, 196, 234, 239, 240, 243, 245, 247, 252, 253, 254, 261, 264, 265, 267, 269, 270, 271, 273, 276, 278, 281, 298, 351, 354, 355, 356, 357, 358, 359, 360, 369, 370, 383, 386, 395, 396, 397, 401, 402, 403, 404, 407, 412, 413  
 Temperature · 96, 103, 133, 137, 149, 156, 161, 167, 168, 179, 190, 201, 208, 236, 252, 254, 260, 383, 386  
 Temple of Abu Simbel · 49  
**Termination Shock** · 118  
 Terrestrial · 116, 125, 413  
 Tharsis Bulge · 172, 413  
 the gravitational force · 312  
 theory · 26, 27, 32  
 Theory · 120, 121, 122, 150, 159, 304, 305, 306, 312, 331, 348, 349, 355, 356, 357, 397, 398, 402, 403, 404, 406, 408, 411, 412  
 tidal effects · 159  
 tidal forces · 157, 185, 187  
 tidally locked · 37  
 tides · 37, 155, 367  
 Titan · 194, 195, 196, 197, 214, 371, 414  
 Transit · 160  
 Transition Zone · 240, 414  
 Transits · 111, 160, 184, 408  
**Transverse Motion** · 101, 250  
 triangulation · 24  
**Triangulation** · 105, 106, 107, 381  
**Trifid Nebula** · 295  
 Triple-Alpha · 283, 298  
 Triton · 212  
 Trojan Asteroid · 221  
 tropical year · 34  
 trough · 67  
 Trough · 414  
**True Motion** · 101, 250  
**Tully-Fisher Relation** · 107, 108, 414  
 Type I Supernova · 311  
**Type Ia Supernovae** · 109  
 Type II Supernova · 311

---

**U**

**Ultra-Long Gamma Ray Bursts** · 303  
ultraviolet · 71, 84, 86  
**Ultraviolet** · 85, 141, 398, 405, 407, 414  
umbra · 39  
Umbral · 242, 414  
universe · 51  
Universe · 20, 261, 271, 344, 345, 346, 354, 396, 397, 398, 399, 401, 402, 403, 404, 405, 406, 407, 408, 409, 410, 415  
Uranium · 283, 410  
**Uranus** · 116, 125, 130, 200, 201, 202, 203, 204, 205, 206, 210, 213, 221, 231, 404, 413

---

**V**

Valles Marineris · 124, 172  
Variable Stars · 108, 257, 346, 414  
Venus · 27, 50, 51, 56, 85, 105, 116, 124, 125, 157, 161, 162, 163, 164, 165, 166, 167, 370, 396, 397, 402, 404, 410, 411, 413  
vernal equinox · 36, 63  
Very Large Array · 89  
Very Large Telescope · 90  
Very Long Baseline Array · 89  
Vibration · 100, 406  
Virgo Supercluster · 20, 320  
Viruses · 366  
visible light · 70  
voids · 121, 341, 344, 364  
volcanic · 158, 163, 172, 367  
Voyager 1 · 118, 130, 188  
Voyager Spacecraft · 373

---

**W**

water · 15, 45, 50, 69, 118, 122, 124, 127, 128, 135, 138, 139, 141, 143, 146, 152, 166, 172, 173, 174, 175, 176, 185, 196, 202, 209, 212, 234, 240, 246, 292, 293, 365, 366, 367, 369, 370, 371, 374, 398, 403, 404, 407, 410, 414  
wavelength · 68, 70, 89, 94, 95, 102, 110, 294, 342, 383, 384, 410, 413  
**Wavelength** · 383, 384, 415  
wavelength · 67  
waxing · 38  
Weird Terrain · 158  
White Dwarf · 254, 261, 270, 271, 290, 298, 299, 300, 310, 311, 397, 407, 408  
White Dwarf Stars · 254  
White Dwarfs · 257, 261, 286, 287, 415  
winter solstice · 36, 48

---

**X**

x-rays · 71, 84  
**X-Rays** · 307, 334, 336, 415

---

**Y**

yellow dwarf · 276

---

**Z**

zenith · 22  
**Zenith** · 395, 415  
Zenithal Hourly Rate · 227  
**Zones** · 181, 234, 235, 415

